

Network Monitor Signal Tower With MP3

# **NH-FV Series User's Manual**

**Model**

**NHL-FV2**

**NHP-FV2**

# Introduction

Thank you for purchasing the PATLITE “NH Series” (henceforth, written as “this product”) Network Monitoring Signal Tower. Be sure to read this NH Series instruction manual (henceforth, written as “this book”) carefully before installation. In addition, store this manual for future reference when performing maintenance, repairs or inspections. When performing maintenance and repairs, etc., be sure to reread this book.

After reading this book, if there are any questions regarding this product, contact your PATLITE Sales Representative from the contact list indicated at the end of this book.

## Notice







- ▶ The copyrights of this book is owned by the PATLITE Company, Inc. (henceforth referred to as “our company”). Any reproduction, duplication, alteration, or extracting portions of this book, etc., without written permission from our company is forbidden.
- ▶ Specifications, the design, and other contents written in this book may be changed for improvements without prior notice and may result in differences from the actual product purchased.
- ▶ This product meets severe quality control and inspection requirements prior to shipment, but if some failure or defect is found, contact the place of purchase, or your PATLITE Sales Representative (indicated on the last page) to solve the issue.
- ▶ This product (software is included) is for the use of general office work, home and for personal use, it has been developed, designed and manufactured for general applications, such as for industry, and it is not designed for applications which demands high safety requirements, such as equipment or systems used in connection directly, or indirectly, with human life.  
Understand prior to use, that no responsibility is taken at our company for damages or other disadvantages, due to customers using this product beyond the scope of its general application, or from any claims from third parties.
  - When using this product for applications in which equipment of higher reliability than the general application demands, such as a computer system, etc., use suitable safety design countermeasures against system failure, etc.
- ▶ Understand that our company does not take any responsibility for damage and other disadvantages this product (software is included) has caused due to the customer using this product, or any claims from third parties.
- ▶ Due to the characteristics of the LED's, variations in brightness and color of the indicating lamps may occur.
- ▶ To comply with UL certification for the main unit, An AC adaptor with a UL listing is required.

## FCC Compliance

This equipment has been tested and found to comply with the limits for a Class A digital device, pursuant to Part 15 of the FCC Rules. These limits are designed to provide reasonable protection against harmful interference when the equipment is operated in a commercial environment. This equipment generates, uses and can radiate radio frequency energy and, if not installed and used in accordance with the instruction manual, may cause harmful interference to radio communications. Operation of this equipment in a residential area is likely to cause harmful interference in which case the user will be required to correct the interference at his own expense.



## For safe application, observe the following:



The following symbols classifies the following into different categories and explains the level of harm inflicted if the cautions are disregarded.

 <b>WARNING</b>	Indicates an imminently dangerous condition: Failure to follow the instructions may lead to death or serious injury.
 <b>CAUTION</b>	Indicates a potentially dangerous condition: Failure to follow the instructions may lead to slight injury or property damage.
 <b>PROHIBITED</b>	This symbol indicates “Prohibited”, which should not be carried out by all means.
 <b>ENFORCED</b>	This symbol indicates “Enforced”, which should be observed and carried out by all means.
 <b>Attention</b>	Indicates something to observe before using this product.
 <b>MEMO</b>	Notice regarding supplementary information or convenient explanation is indicated.

## Cautionary Notes

Prior to installation, read all notes and use this product correctly.

 <b>WARNING</b>	
	<ul style="list-style-type: none"> <li>Do not modify or disassemble this product. Failure to follow these instructions could result in fire or electric shock.</li> <li>Do not use this product when there is condensation. Failure to follow these instructions could result in fire or electric shock.</li> <li>Do not leave or use this product while the LED unit are detached or broken. Doing so may result in electric shock.</li> <li>Do not touch the electric socket with wet hands. It may result in electric shock.</li> <li>Do not allow the voltage to exceed the specified voltage tolerance. Exceeding the voltage ratings beyond the rated voltage will cause internal circuitry damage. Moreover, possible fire may also occur.</li> <li>After attaching this product onto the machinery, Do not remove the cover, hook anything onto the product or use the product as a step When climbing onto the machinery. Failure to comply may result in falling off the machinery or product damage may occur.</li> <li>Do not disconnect and re-insert the DC plug while the AC adaptor is plugged in. Possible electric shock and damage may occur.</li> </ul>
	<ul style="list-style-type: none"> <li>Always use a power supply within the operating voltage range. Failure to follow this instruction could result in fire or product failure.</li> <li>In the unlikely event that there is an abnormal situation such as smoke or odors emitting from the product, immediately cut the power supplied to the product. Continued use of the product in this condition could result in fire or electric shock.</li> <li>When plugging into the power receptacle, be sure to check there is no dust accumulation on the plug, and insert into the power receptacle completely. By allowing dust to adhere, it can be the result of fire or failure from short-circuiting.</li> <li>Since dust can accumulate After a long time, and with moisture, can cause the dust to become conductive, in order to prevent the phenomenon of ignition from dust accumulation, it is best to periodically wipe the transformer and socket terminal with a damp cloth. By allowing dust to adhere to the power receptical, it can be the result of fire or failure from short-circuiting.</li> <li>When installing, wiring, or replacing parts, be sure to turn off the power first to prevent electric shock.</li> <li>When an unusual odor, sound or smoke comes out of the product, immediately disconnect the power, then contact your nearest PATLITE Sales Representative.</li> <li>In order to prevent serious effects on human life and property etc. caused by malfunction of this product, ensure sufficient safety such as using in combination with other equipment.</li> </ul>

 CAUTION	
	<ul style="list-style-type: none"> <li>• Please place this product on a level surface, such as a desk etc.</li> <li>• When installing in high places, such as a top shelf, fix the Main Unit so it cannot move or fall.</li> </ul>
	<ul style="list-style-type: none"> <li>• Do not expose it to high temperatures, such as near a fire and do not use it in humid places. Moreover, do not use this machine in locations where corrosive or combustible gas is present.</li> <li>• If foreign substances, such as water, medicine; or metals, such as copper, low carbon steel wire, fall into this product, please do not use it. Possible cause of failure may occur.</li> <li>• Do not bend the power supply cables or signal wires recklessly. Failure to comply will result in possible malfunction due to disconnection.</li> <li>• Do not install or run wiring near, or where equipment (such as solenoids, etc.) generate strong electric or magnetic fields, or near any power lines. Failure to comply may result in malfunction due to inductive noise.</li> <li>• Do not place any part of this product (Body, AC Adaptor, Rubber Feet) where infants can reach it. If it is swallowed accidentally, it could be detrimental. If it is suspected of being swallowed, consult an emergency medical center immediately.</li> <li>• Do not use excessive force to set up the switches. Possible damage or malfunction may occur.</li> <li>• Do not adjust switches with a sharp object. Possible damage to switches may cause it to be impossible to operate or cause partial movement of the contacts.</li> </ul>

## Regarding the Trademarks or Registered Trademarks

- Microsoft, Windows, and Internet Explorer are registered trademark of the Microsoft Corporation of America, Japan and other countries.
- Google Chrome is a trademark or registered trademark of Google Inc.
- Firefox is the trademark or registered trademark of the Mozilla Foundation of America and other countries.
- "PATLITE" and "Patlite" are trademarks or registered trademarks of the Patlite Corporation of Japan.
- Other company names and brand names written in this book are trademarks or registered trademarks of each company.

## Handling Cautions

Work that was recorded or copied from music CDs or other media used in public places may infringe upon copyrights and law enforcement may be imposed. When using a work that was recorded or copied from music CDs or other media, be sure to obtain permission from the author.

In addition, copyright of audio/music data distributed or sold by PATLITE Corporation belongs to PATLITE. It is strictly prohibited to copy/reprint whole or partial contents of audio/music data belonging to PATLITE Corporation, or to transfer/sell such material on computer networks etc., without permission of the rightful holder.

- Windows® is a registered trademark of Microsoft Corporation of America, Japan and other countries.
- The PATLITE Corporation is a member of the SD Card Association.

## Handling Cautions

This product is for indoor use only. Do not use it outdoors.

When installing this product, avoid installation in the following places:

- Where its exposed to direct sunlight
- Where high temperatures, such as near fire, or in a humid place
- Where drastic temperature and humidity changes are present
- Where its exposed to an environment with poor ventilation
- Where its exposed to vibrations exceeding the specifications
- Where its exposed to corrosive gas
- Where its exposed to a salty air environment
- Where its exposed to dust, iron powder, etc.
- Where its exposed to high concentrations of chemicals or oil mist
- Where its exposed to rain, or other types of wet environments



## Maintenance and Inspection

### ► Cleaning

- When cleaning, be sure to disconnect the power before doing so.
- The cleaning of this product should be with a soft cloth and a neutral detergent (such as dish soap), diluted with water and should be wiped lightly. Since it is easy to crack the surface of the product when wiping with too much strength, be careful.
- Do not wipe this product with volatile chemicals, or chemically treated dustcloth containing benzene, thinner etc.
- Do not wipe with a cloth containing too much moisture. If moisture gets inside the product, it can cause short circuiting, electric shock, or fire.
- Periodically remove dust from the electric socket to prevent a fire hazard. By allowing dust to adhere to the power supply terminal, it can be the result of fire or failure from short-circuiting.

### ► Inspection

- Check the following contents when inspecting this product.

Inspection Checklist		Inspection Contents
Supplied Power Source	Power Supply Voltage Tolerance	Tolerable Voltage Range should be from AC 100 to 240V
Surrounding Environment	Ambient Temperature	Operating Temperature Range should be from 0 to 40°C
	Ambient Humidity	Operating Humidity Range should be 20 to 80% RH
	Presence of Dust	No dust should be accumulated

## Product Checklist

Although our company takes all possible quality control measures to ensure proper packing of this product, if there should be any missing items, refer to the last page to contact your nearest PATLITE Sales Representative.

- Main Unit (1 Body )
- NH-FV Series Installation Manual (1 Sheet)
- Rubber Feet (4 Pieces)
- AC Adaptor(1 pc.)
  - \* Not included in N model.
  - \* AC adaptor and Replacement plug are included in W model.

# Table of Contents

## 1. Product Outline 10

1.1.	Outer Dimensional Drawing	10
1.1.1.	Main Unit	10
1.1.2.	AC Adaptor	10
1.2.	Part Names and Functions	11
1.2.1.	Main Unit	11
1.2.2.	AC Adaptor	11
1.3.	Model Number Configuration	12
1.4.	General Specifications	13
1.5.	About AC Adaptor	14
1.6.	Description of Functionality	15
1.6.1.	Monitoring Function	15
1.6.2.	Transmission Command	15
1.6.3.	Transmission/Output Function	16
1.6.4.	Setup and Updates	16

## 2. Installation Procedure and Flowchart 17

2.1.	Installation Procedure and Flowchart	17
2.2.	Product Installation	18
2.2.1.	Placing in an unfixed location	18
2.2.2.	Wall-mount Bracket (Option)	19
2.3.	Terminal Buss Wiring	20
2.3.1.	Input Terminal Buss and Output Terminal Mount Wiring	20
2.4.	LAN Connection	21
2.5.	Line Out Connection	21
2.6.	Power Connection	21
2.7.	Network Setup	23
2.7.1.	Login	23
2.7.2.	Setting the IP Address	25
2.7.3.	Setup Confirmation	27
2.8.	Network Setup with DHCP Function	28
2.9.	Operation Setup	29
2.9.1.	Clock Setup	29
2.9.2.	Normal Mode Setup	29

## 3. Functionality Details 30

3.1.	MP3 Playback Function	30
3.1.1.	Playback Event	30
3.1.2.	Channel	31
3.1.3.	Playback Pattern	32
3.1.4.	Master Volume Function	32
3.1.5.	Lineout Function	32

3.1.6.	MP3 File Registration	33
3.1.7.	Playback Mode	34
3.1.8.	Preset Channel	36
3.2.	Digital Input Function	37
3.2.1.	Digital Contact	37
3.2.2.	Digital Input Monitoring Function	38
3.2.3.	Digital Input Circuit Diagram	39
3.2.4.	Digital Input Condition Setup for "Clear" Function	39
3.2.5.	Relay Contact Output Control Function	40
3.2.6.	Automatic Digital Output OFF Function	41
3.2.7.	Relay Contact Output Circuit Diagram	41
3.3.	Signal Tower Control Functions	42
3.4.	Test Function	43
3.5.	SNMP Function	44
3.5.1.	SNMP SET with Channel Playback	44
3.5.2.	SNMP GET with Channel Playback	44
3.5.3.	TRAP Reception Function	44
3.5.4.	TRAP Transmission Function	45
3.6.	SNMP Supported Equipment Monitor Function	46
3.6.1.	Condition Agreement Detection	46
3.6.2.	Change Detection	50
3.7.	PHN Command Reception Function	51
3.8.	PNS Command Reception Function	53
3.9.	Mail Transmission Function	58
3.9.1.	E-mail Message Contents	58
3.10.	RSH Command Function	60
3.10.1.	RSH Command Reception	60
3.10.2.	RSH alert Timer Reset Function	64
3.11.	Ping Monitoring Function	66
3.11.1.	Ping Monitoring Function	66
3.11.2.	Ping Monitoring Function ("Clear" Command Outside Sources)	67
3.12.	Application Monitoring Function	68
3.13.	SLMP Read Command Transmission Function	69
3.13.1.	SLMP Reading Command Transmission Process	70
3.13.2.	SLMP Read Command Transmitter Function Details (Conditions Agree)	71
3.13.3.	SLMP Read Command Transceiver Functional Details (Error Occurs)	71
3.14.	SLMP Write Command Transmission Function	73
3.15.	"Clear" Operation Function	74
3.15.1.	"Clear" Operation Execution	75
3.15.2.	"Clear" Switch Operation Setting	75
3.16.	Digital Input Condition Setup Function	77
3.17.	Reinitialization Function	78
3.18.	Configuration Data Save/Load Setup	79
3.19.	Event Log Output Function	80
3.20.	XML Data Output Function	82
3.21.	USB Memory Function	83

3.22.	Mode Switch Operating Functions	84
3.23.	Reset Function	96
3.24.	Firmware Update Function	96
3.25.	HTTP Command Control Function	97
	3.25.1. Example	98
3.26.	Scheduling Function	99

## 4. Function Setup

101

4.1.	System Configuration Screen	102
4.2.	Clock Settings Screen	103
	4.2.1. PC Clock Synchronization	104
	4.2.2. Synchronizing with an NTP server	105
	4.2.3. Setting the Time zone	105
4.3.	User Authentication Configuration Screen	106
4.4.	SNMP Configuration Screen	107
	4.4.1. SNMP Command Transmit and Receive	107
	4.4.2. SNMP Supported Equipment Monitor	107
	4.4.3. SNMP TRAP Reception	107
	4.4.4. SNMP TRAP Transmission	107
4.5.	Socket Transmission Configuration Screen	109
4.6.	E-Mail Settings Screen	110
4.7.	E-Mail Message Settings Screen	112
4.8.	RSH Command Configuration Screen	113
4.9.	Relay Contact Output Setup Screen	115
	4.9.1. Digital Output Mode Setup	115
	4.9.2. BUSY Output Mode Setup	116
4.10.	Sound Channel Setup Screen	117
	4.10.1. Playlist Data (Ch1-Ch15, Ch16-Ch30)	118
	4.10.2. Web Setup Data (Ch31-Ch40, Ch41-Ch50, Ch51 - Ch60)	119
	4.10.3. Preset Channel (Channel 61-70)	120
4.11.	Scheduling Setup Screen	121
4.12.	Digital Input Setup Screen	122
4.13.	TRAP Reception Configuration Screen	125
4.14.	Ping Monitoring Configuration Screen	128
4.15.	Application Monitoring Configuration Screen	130
4.16.	"Clear" Control Configuration Screen	132
	4.16.1. "Clear" Control Configuration ("CLEAR" Button)	132
	4.16.2. "Clear" Control (SNMP Clear, RSH Clear)	133
4.17.	Normal Mode Settings Screen	134
4.18.	Test Switch Setup Screen	135
4.19.	SLMP Read Command Configuration Screen	136
	4.19.1. SLMP Read Command Setup Screen	136
	4.19.2. Common Operation Setting Screen for SLMP Error	139

4.20.	SLMP Write Command Configuration Screen	141
4.21.	SNMP Supported Equipment Monitor-Detection Screen 1	143
4.22.	SNMP Supported Equipment Monitor-Detection Screen 2	146
4.23.	Digital Input Condition Settings Screen	148
4.24.	Signal Tower Output Control Screen	150
4.25.	Reinitialization Screen	151
4.26.	Reboot Screen	152
4.27.	Event Log Screen	153
4.28.	XML Settings Screen	154
4.29.	Configuration Data Setup Screen	155
4.30.	Firmware Update Screen	156
4.31.	Setup Table Entries Screen	157
4.32.	Logout Screen	158

## **5. MIB 159**

---

## **6. Replacement Parts Option Parts 164**

---

6.1.	Replacement Parts	164
6.2.	Option Parts	164
6.2.1.	Tint Film	164
6.2.2.	Cooperation services	165
6.3.	About LED Unit	165
6.3.1.	How to attach and detach LED Unit	166

## **7. Inspection and Maintenance 168**

---

## **8. Troubleshooting 169**

---

## **9. Freeware Terms of Agreement 172**

---

9.1.	GNU GENERAL PUBLIC LICENCE	172
9.2.	GNU LESSER GENERAL PUBLIC LICENSE	176
9.3.	NET-SNMP	178
9.4.	BSD LICENCE	181

# 1. Product Outline

## 1.1. Outer Dimensional Drawing

### 1.1.1. Main Unit

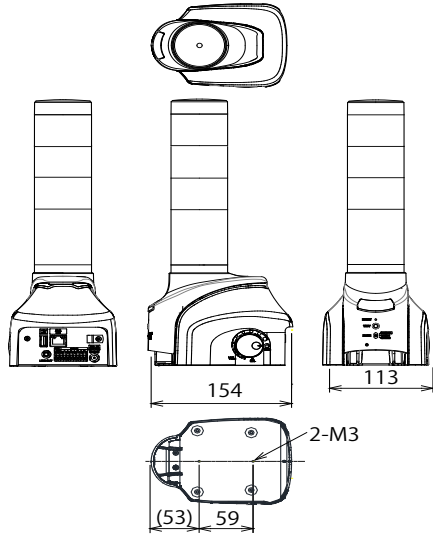

Dimensions of common part

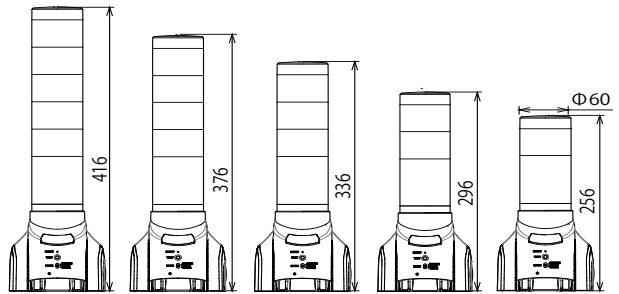

Distinctive dimension of NHL

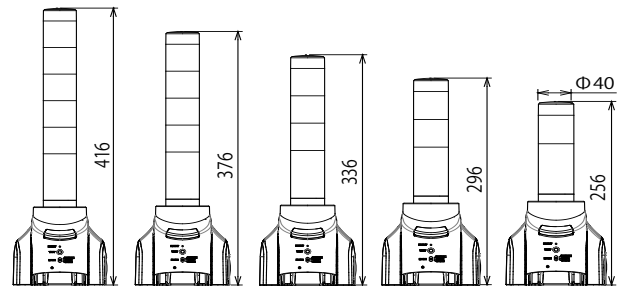

Distinctive dimension of NHP

### 1.1.2. AC Adaptor

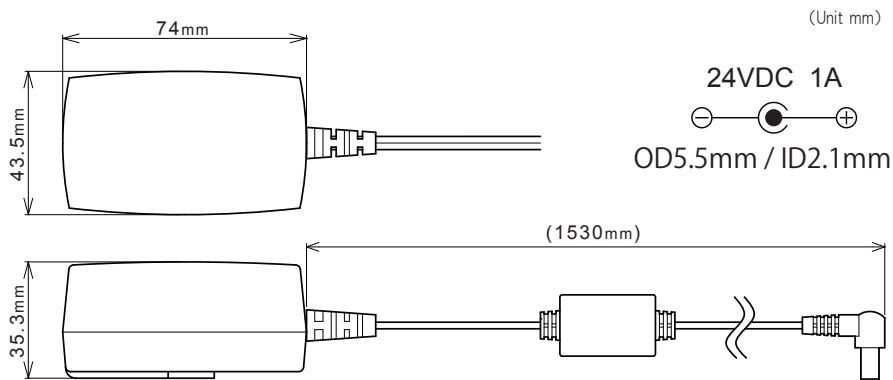

## 1.2. Part Names and Functions

### 1.2.1. Main Unit

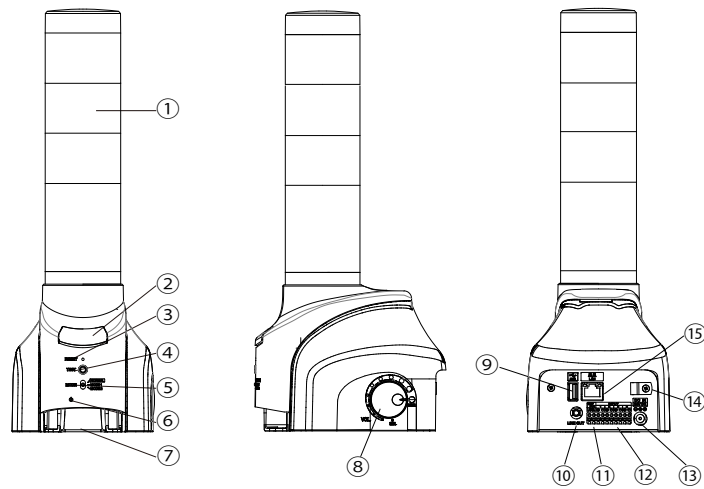

Number	Name
1	LED Unit
2	“CLEAR” Switch
3	“RESET” Switch
4	“TEST” Switch
5	“Mode” Switch
6	Status LED Indicator
7	Speaker Diaphragm
8	Volume
9	USB port
10	Line Out
11	Output Terminal
12	Input Terminal
13	DC Jack
14	Power Cable Clamp
15	LAN Connector

### 1.2.2. AC Adaptor

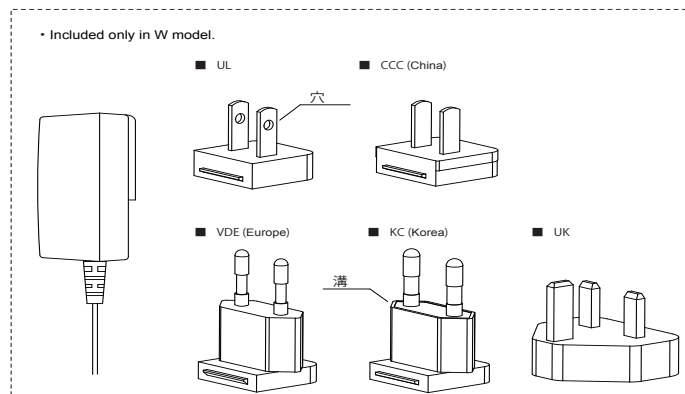
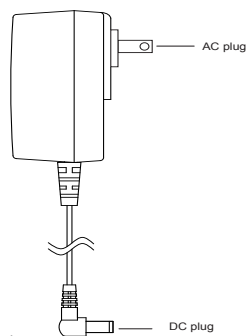

### 1.3. Model Number Configuration

NH  -  FV2  -

1

■ LED Unit Color  
(From top to bottom)

■ AC Adaptor  
None : AC Adaptor included  
W : AC adaptor included  
Replacement plug included  
N : AC Adaptor not included

■ Signal Tower Tires  
Tiers (1-5)

■ Signal Tower Type  
P : LR4(Φ40)  
L : LR6(Φ60)



## 1.4. General Specifications

### General Specifications

Model	5 tiers	NHL-5FV2	NHP-5FV2
	4 tiers	NHL-4FV2	NHP-4FV2
	3 tiers	NHL-3FV2	NHP-3FV2
	2 tiers	NHL-2FV2	NHP-2FV2
	1 tier	NHL-1FV2	NHP-1FV2
Rated Voltage		24VDC (Main Unit)	
	AC Adaptor	Input: 100VAC - 240VAC (50/60Hz) Output: 24VDC	
Operating Voltage Range		Rated Voltage $\pm 10\%$	
Rated Power Consumption	Main Unit	Standby: 2.2W Maximum: 3.5W (with AC Adaptor, 100VAC input)	
	LED Unit	1.0W (per Unit)	
Operating Ambient Temperature		0°C - +40°C (No Dew or Condensation)	
Operating Ambient Humidity		20% - +80% RH (No Dew or Condensation)	
Storage Ambient Temperature		-10°C - +60°C (No Dew or Condensation)	
Storage Ambient Humidity		20% - +80% RH (No Dew or Condensation)	
Mounting Location		Indoor Only	
Mounting Direction		Upright	
Protection Rating		IP 20	
Insulation Resistance		More than 10M $\Omega$ at 500VDC between live part and non-current carrying metallic part *1	
Withstand Voltage		1500VAC applied for 1min (10mA or less) between live part and non-current carrying metallic part without breaking insulation *1	
Mass (Tolerance $\pm 10\%$ ) (AC Adaptor not include)	5 tiers	1270g	1085g
	4 tiers	1210g	1050g
	3 tiers	1150g	1015g
	2 tiers	1090g	980g
	1 tier	1030g	945g
Outer Dimensions		Refer to the Outer Dimension Drawing	
Sound Pressure Level		88dB or more	
	Environmental Condition	Front direction from the center, at 1m, (1kHz sine wave played back at -6dB) MP3 data of the content and use of the environment, the sound pressure level will change.	
Audio Line Output		600 $\Omega$ 0dBv (Unbalanced, Monaural Mini-Jack)	
Communication Method (LAN)		Ethernet (Conforms to the IEEE 802.3) 10BASE-T / 100BASE-TX (Auto negotiation, Full Duplex / Half Duplex)	
Interface	USB Port	USB2.0 / 1.1 Type-A 1ch (For USB Memory)	
External Contact Output		Non-voltage contact output	
	Number of Contacts	1	
	Contact Capacity	(30VDC @ 3A) inrush current 5A or less (5VDC @ 1mA, Minimum, Reference)	
	Wire Diameter	Solid Wire / Stranded Wire: $\phi$ 0.41 - 0.81mm (AWG26 - 20)	
	Wiring Method	Screwless terminal block	
External Contact Input		Non-voltage contact input NPN Transistor	
	Number of Contacts	4	
	Contact Capacity	"ON" output current @ 6mA or less per channel Terminal OFF condition Voltage: 24VDC	
	Wire Diameter	Solid Wire / Stranded Wire: $\phi$ 0.41 - 0.81mm (AWG26 - 20)	
	Wiring Method	Screwless terminal block	
Operating portion		"Volume", "Reset" Switch, "Clear" Switch, "Mode" Switch, "Test" Switch	
Accessories		AC Adaptor *1, Replacement plug (5 pcs.) *2, Installation Manual, Rubber feet (4pcs.)	
Option		Wall Bracket (NH-WST2), Tint Film (NHL-TF, NHP-TF)	
Conformity Standards		RoHS Directive (EN 50581) EMC Directive (EN 55032 (Class A), EN 55024) FCC Part15 Subpart B Class A, ICES-003 Class A UL 1638, UL 464, CSA C22.2 No.205 KC (KN 61000-6-2, KN 61000-6-4) *3 PSE Compliant AC Adaptor	
Remark		*1 : N type excluded *2 : Only W type *3 : Only N type and W type CE Marking UL/cUL Listed W type is an international model.	

## 1.5. About AC Adaptor

### ⚠ WARNING



- When using an AC adaptor other than our AC adapter (ADP-001), be sure to use the AC adaptor that conforms to the recommended specifications. Using an AC adaptor that does not meet the recommended specifications could result in fire or product failure.
- Be sure to use the AC adaptor equipped with the overcurrent protection. Using an AC adaptor that does not have an overcurrent protection function could result in fire or product failure.

- Use the AC adaptor included in the product. To order an AC adaptor separately, purchase our AC adaptor(ADP-001).
- When using N model (AC Adaptor not included) and AC adaptor other than ADP-001, use AC adaptor with the following specifications.

When ordering an AC Adaptor separately, use the following specifications.

Failure to comply may result in failure of this product.

[Recommended AC Adaptor Specifications]

#### DC Secondary Output

Voltage	: 24V DC $\pm$ 5%
Current	: 0.75A or more and 1A or less (With overcurrent protection)
Plug Length	: 9.5mm or more
Plastic Housing	: 10mm dia. or less
Plug Connector Outer Diameter	: 5.5mm dia.
Plug Connector Inner Diameter	: 2.1mm dia.

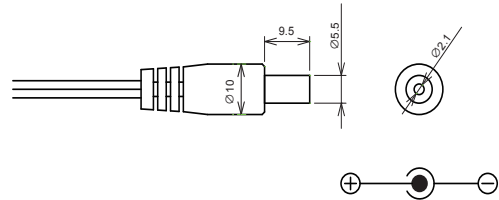

## 1.6. Description of Functionality

The following explains the functionality featured in this product.

### 1.6.1. Monitoring Function

This product can monitor the function of a network device, or device connected to the output contacts.

#### PING MONITOR

##### Monitors "keepalive" Network/Device signals

This product can monitor the function of a network device or device connected to the contact output. When an abnormal response in the network of this product is not obtained, it judges an abnormal state and warns the administrator promptly with light and sound.

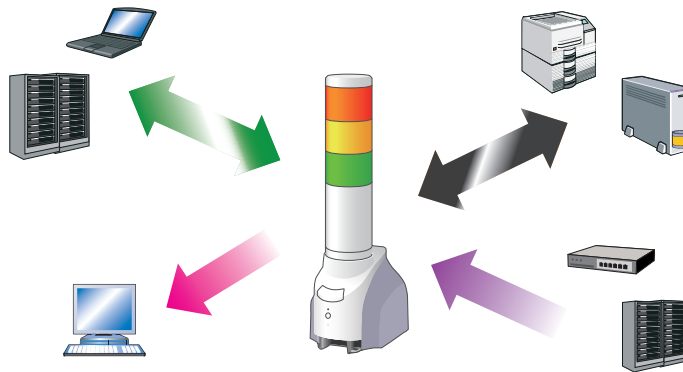

#### SNMP v1v2c

##### Low-cost Monitor networking equipment.

This product can warn an administrator of generated abnormalities and hindrances promptly with an SNMP command to respond with light and sound to an SNMP TRAP from the equipment (UPS, a printer, a router, a switch, etc.) via the network.

This product can also transmit the SNMP command to compatible equipment in a network to monitor its status.

- It can distinguish the variable bindings.
- The registration of 16 groups (4 nodes per group) is possible.

#### APPLICATION MONITOR

##### Monitor Application Software

By the user creating an additional commands, the monitoring of a program application' operating condition can be done. (Maximum of 4 nodes)

#### DIGITAL INPUT

##### Monitor equipment using digital input

This product has four digital inputs to monitor signal inputs from equipment, and has a contact output. The operation of this product needs to be set up beforehand to adapt to the input state changes of the equipment.

### 1.6.2. Transmission Command

#### RSH

##### Controllable with General RSH protocol

It is controllable by the flexible RSH protocol. With network integrated management software and various event monitoring tools, it is possible to trigger lighting, flashing, buzzer sound, and buzzer sound synchronized with the Signal Tower lights.

#### HTTP COMMAND

##### Controllable with HTTP command

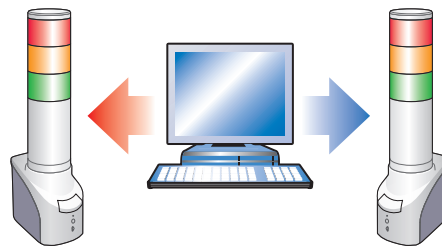

#### SOCKET TRANSMISSION

##### Compatible with PHN Commands.

The Signal Tower and buzzer are controllable by a 2 byte command.

- \* Compatible with the NHE-3 FB, NHC-3 FB, NHM-3 FB and PHN-3FBE1.
- \* Some functions are limited.

Event Occurance: Command Execution (Flashing Tier Lights, Buzzer Sound)  
PHN Example Code: 57H,17H

Event Occurance: Command Execution (Lighting Tier, Sounding Buzzer)  
RSH Example: rsh 192.168.10.1 -l root alert 111001

The commands are compatible with the new PNS.

The Signal Tower and buzzer are controllable through the PNS command. All the different patterns are controllable.

Event Occurance: Command Execution (Lighting Tier, Sounding Buzzer)  
PNS Example Code: 58H,58H,53H,00H,00H,06H,01H,01H,01H,00H,00H,01H

### 1.6.3. Transmission/Output Function

E-mail and TRAP transmissions can be done during the occurrence of an event.

#### DIGITAL OUTPUT

This product can control equipment with one digital output and a contact input.

#### LINE OUT

This product can send a channel output during playback with one line-out and line-in to the equipment.

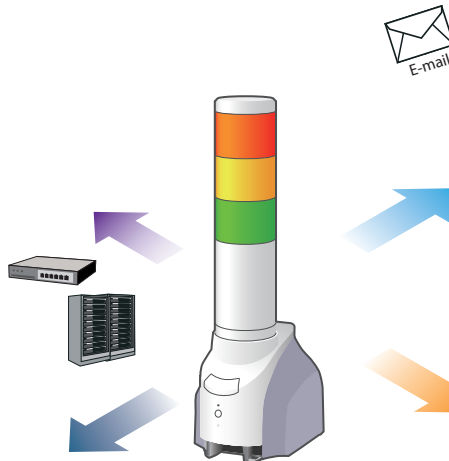

#### E-mail TRANSMISSION

Send a maximum of 8 selectable registered E-mails.  
Uses POP and SMTP authentication protocol.

#### SNMP v2c

Maximum of 8 nodes can be transmitted with an SNMP TRAP.  
Transmission of SNMP TRAP corresponding to an event is possible, up to a maximum of 8 nodes.

### 1.6.4. Setup and Updates

With the web setup tool containing the IP address and detailed setup for the Main Unit, the digital output and "Clear" operation, as well as firmware upgrades and reading/writing configuration data can be done remotely.

In addition, changes to the network setup can be done from the PNS Manager.

Refer to the "PNS Manager" operation manual for the directions on the PNS Manager.

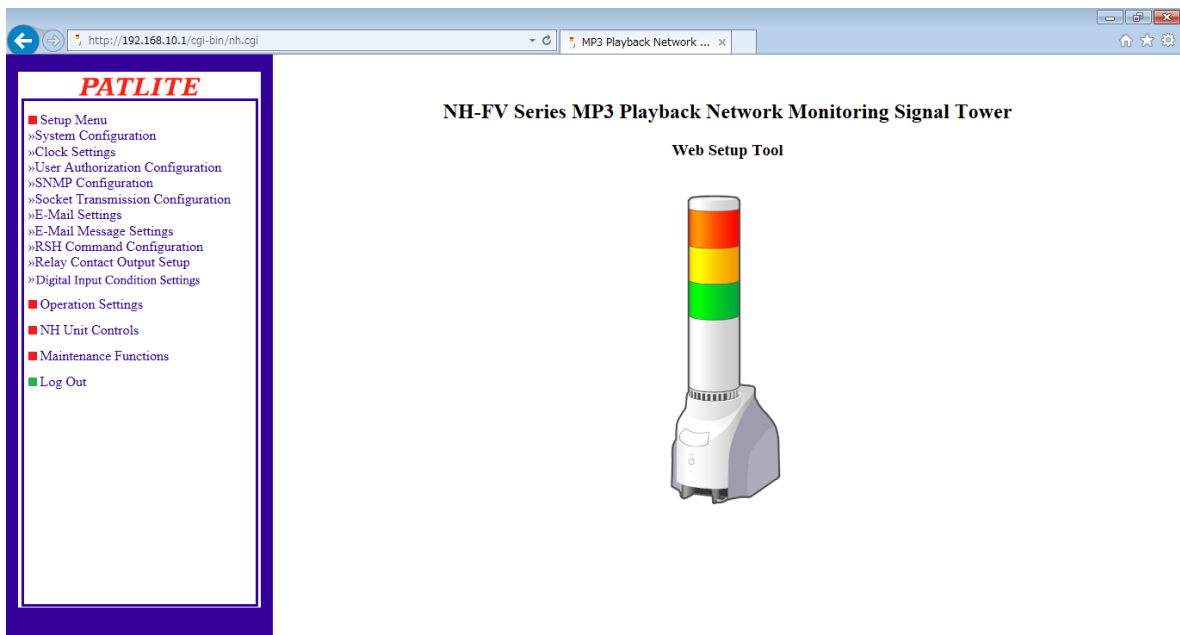
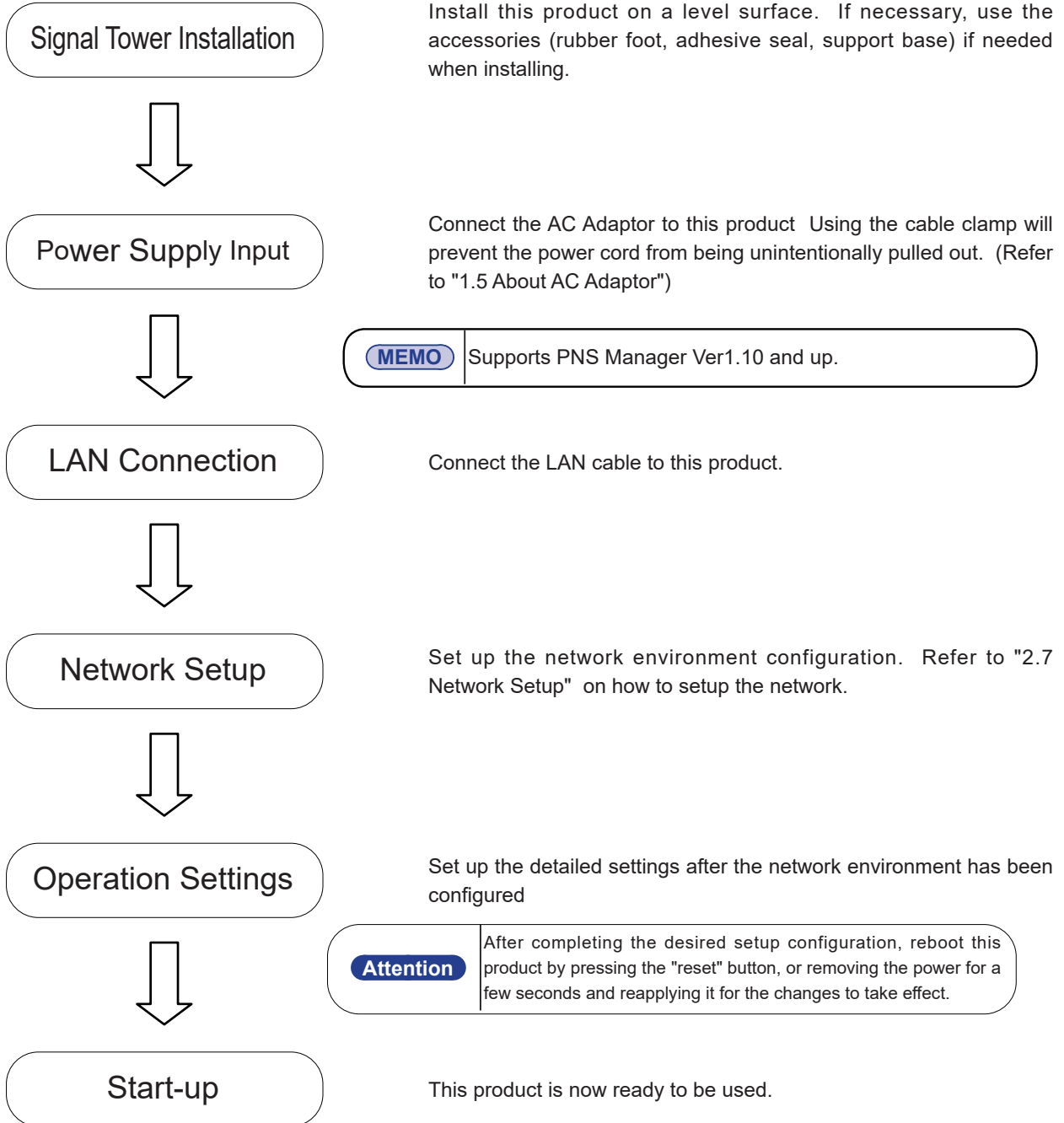

Figure 1.6.4-1 Web Setup Tool Screen

# 2. Installation Procedure and Flowchart

## 2.1. Installation Procedure and Flowchart

This product offers two methods for configuring the network, "Manual Setup" and "Automatic Network Setup" with the DHCP function.



## 2.2. Product Installation

<b>⚠ CAUTION</b>	
<b>⊘</b>	<p>This product is for indoor use only. Do not use it outdoors.</p> <p>When installing this product, avoid installation in the following places:</p> <ul style="list-style-type: none"><li>• Where its exposed to direct sunlight</li><li>• Where high temperatures, such as near fire, or in a humid place</li><li>• Where drastic temperature and humidity changes are present</li><li>• Where its exposed to an environment with poor ventilation</li><li>• Where its exposed to vibrations exceeding the specifications</li><li>• Where its exposed to corrosive gas</li><li>• Where its exposed to a salty air environment</li><li>• Where its exposed to dust, iron powder, etc.</li><li>• Where its exposed to high concentrations of chemicals or oil mist</li><li>• Where its exposed to rain, or other types of wet environments</li></ul>

- This product is to be installed on a level surface.
- Use the Rubber Feet accessory for This product when needed.

### 2.2.1. Placing in an unfixed location

When necessary, adhere the rubber feet (four pieces included) to the bottom of this product.

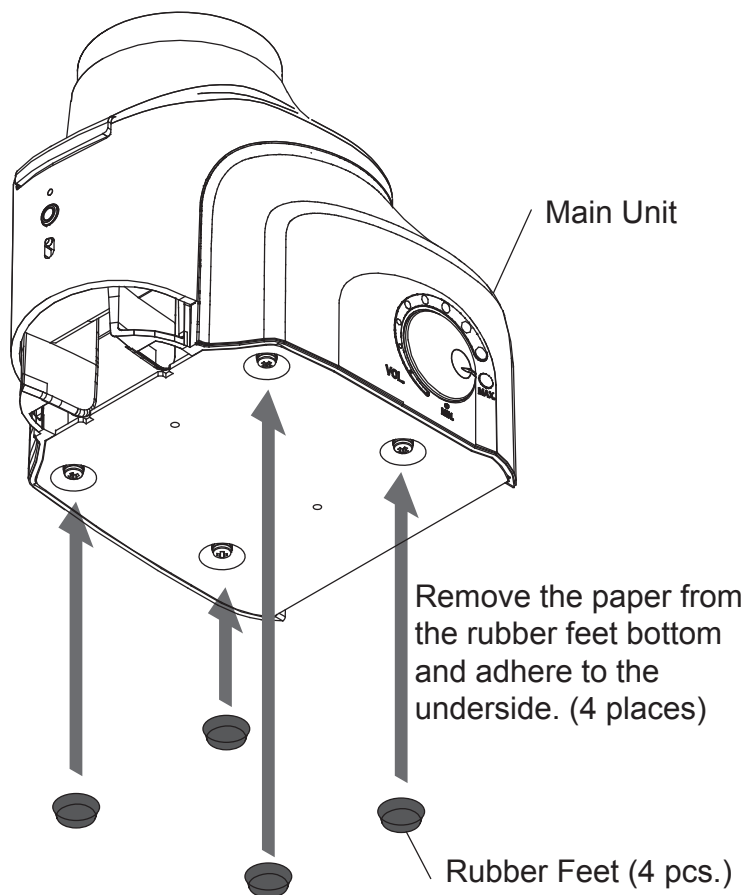
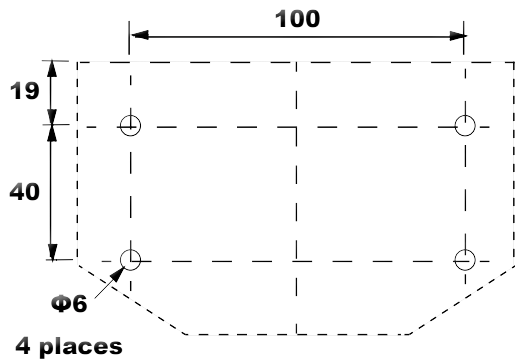

Figure 2.2.1-2 Recommended Rubber Feet Attachment Location

## 2.2.2. Wall-mount Bracket (Option)

Refer to the following figure and use the screws to attach the Wall-mount Bracket.



<<Wall-mount Bracket mounting hole dimensions>>

Refer to the dimensions in the left figure and make mounting holes onto the surface of the wall to install the wall-mount bracket.

### Attention

- The clamping surface should be level and sufficient enough to tolerate shock, vibrations and the weight of the product.
- The depth of the tapped hole should be the required length in accordance with the quality of the surface material of the wall.

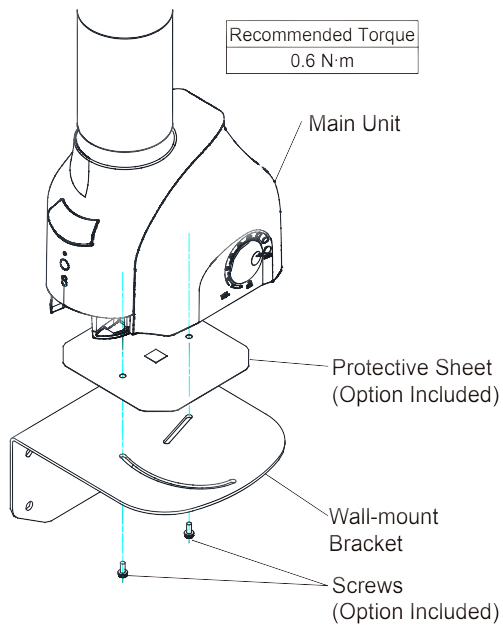

<<Attaching the Main Unit to the Wall-mount Bracket>>

Refer to the figure shown on the left and use the two M3 mounting screws for the wall-mount bracket.

### Attention

- Two mounting screws should be used, along with the recommended torque.

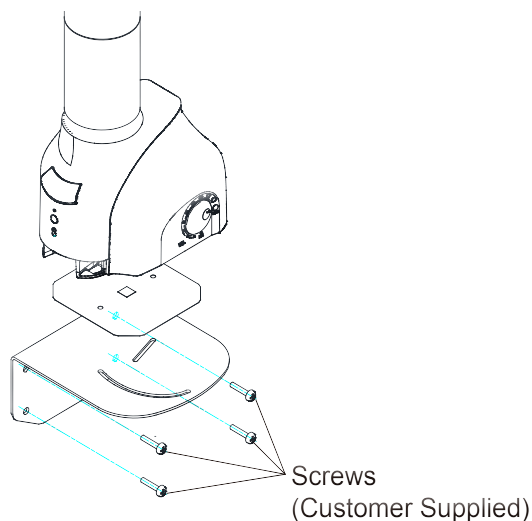

<<Attaching the Wall-mount Bracket to the wall surface>>

Use four M5 screws (not included) and attach the wall-mount bracket as shown in the left figure.

Adjust the bolting torque in accordance with the quality of the surface material of the wall, or the screw length.

## 2.3. Terminal Buss Wiring

<b>⚠ CAUTION</b>	
<b>!</b> Enforced	<ul style="list-style-type: none"> <li>• Be sure the power is turned OFF before performing any electric wiring activity. Failure to comply may result in electric shock.</li> <li>• Double check the wiring to prevent mistakes. Failure to comply will result in equipment damage or fire.</li> <li>• Wire the product so that the lead Wire does not protrude from the terminal. Failure to comply will result in damage due to short-circuiting.</li> <li>• After wiring, verify that there are no loose wires, or they are easy to pull out.</li> </ul>

### 2.3.1. Input Terminal Buss and Output Terminal Mount Wiring

Wire the input terminal stand and output terminal mount in according to the following steps.

#### Wiring Method

- ① . Use a minus driver(\*) and push in the tab of the control unit's terminal buss slot.
- ② . Insert a signal line lead wire into the slot. (Keep pushing the tab while inserting)
- ③ . Release the minus driver to lock the lead wire in place.

\* The minus driver needs to be the following:

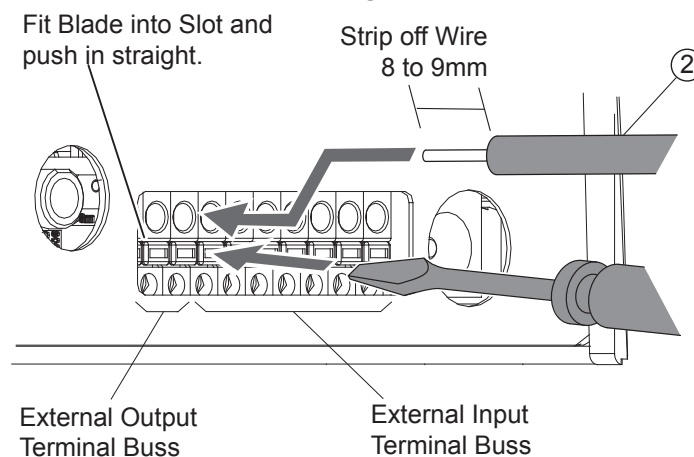

Figure 2.3.1-3 Minus Driver Minimal Specifications

Table 2.3.1-1 Minus Driver Minimal Specifications

Name	Compatible Dimensions
Minus Driver	Blade Width: 1.7-2.1mm
	Blade Thickness: 0.5-0.8mm

#### MEMO

- The following are the gauge sizes used for the terminal buss:
- solid wire:  $\varnothing$  0.4 - 0.8mm (AWG26-20)
- frayed wire: 0.13 - 0.52mm<sup>2</sup> (AWG26-20)
- Be sure the equipment connected to the Main Unit OUTPUT does not exceed its voltage and current ratings.
- Port 1: DC30V at 3A, inrush current 5A or less; Minimum current 1mA; minimum voltage DC5V (Reference Values)
- Be sure the equipment connected to the Main Unit INPUT does not exceed its voltage and current ratings.
- Port 1-4 (NPN Input): Output ON current: 6mA or less/ Port OFF voltage potential: 24VDC



## 2.4. LAN Connection

A LAN cable is connected to this product.

- The LAN cable should be a category 5 twisted-pair cable (UTP or STP).
- The LAN cable can either be a straight or cross cable.

## 2.5. Line Out Connection

A mini phone jack can be connected to this product.

- Be sure to connect with the line-in input of the targeted equipment.
- It is recommended to use a monaural cable.

  
CAUTION

- Do not connect headphones to the lineout. Do not connect to passive speakers. Failure to comply may result in damage to the main unit.
- Connect a monoraul plug to the input. If a stereo plug is used, the sound will come out the left channel only.
- Do not use plugs other than mono/stereo plugs. Failure to comply may result in damage to the main unit.

## 2.6. Power Connection

Attach the power plug for this product in accordance with the figure below.

This product requires at least 40 seconds for the boot-up sequence to complete.

[Applying Power]

- ① . Loosen the screws with a phillips screwdriver and remove the power cable clamp.
- ② . Pass the power cable of the AC Adaptor through the cable clamp.
- ③ . Fix the cable clamp with a screw.
- ④ . Insert the DC plug into the Main Unit. Allow cable slack of about 15mm from the DC plug.
- ⑤ . Insert the AC Adaptor into an electric socket.
- ⑥ . Power is switched on, a Signal Tower does an all-points Light about 1 second, and status LED in the lower part of the front face of this product lights up.

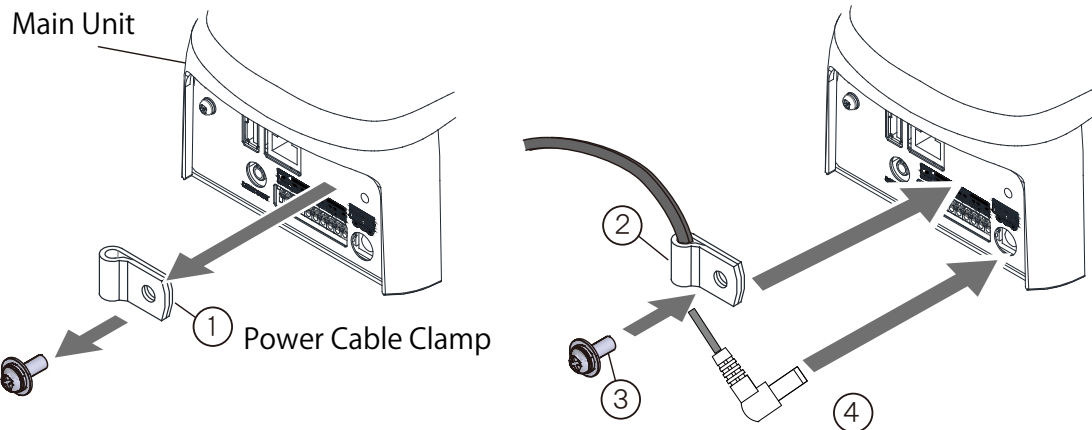

Figure 2.6.0-1 Power Cable

  
WARNING

- Do not disconnect and re-insert the DC plug while the AC Adaptor is plugged in. Possible electric shock and damage may occur.
- Check whether dust has built-up on the electric socket or receptacle plug. If dust has built-up, insert the plug after cleaning. Ensure maintenance to avoid dust build-up, because dust accumulation may result in fire.
- Do not connect headphones, earphones, or passive speakers to the line-out. Failure to comply may result in failure to this product.

**MEMO**

- Replacement plug is included in W model. Follow the procedure below and install the replacement plug in the AC adapter.
- Be sure to use the replacement plug of the same shape as the outlet specification.

**STEP1:**

Insert part A into part B.

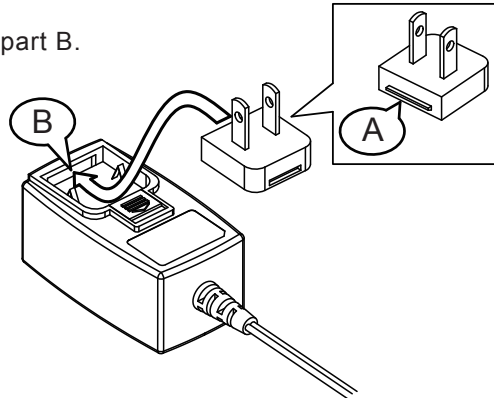

**STEP2:**

Be sure to push in the AC plug from the top, while pulling section C downward.

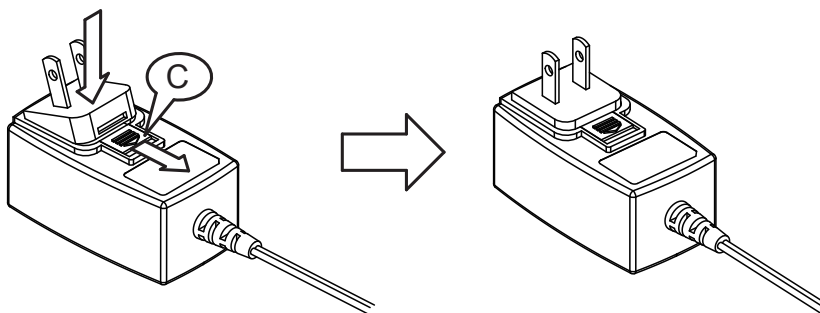

**STEP3:**

Insert the DC jack into the product to be powered.

**STEP4:**

Insert the AC plug portion into the appropriate outlet to supply power to the product.

## 2.7. Network Setup

The default IP address for this product is: **192.168.10.1**

Subnet mask is: **255.255.255.0**

The IP address change should be done by logging in to the web browser of the personal computer (henceforth, PC) to change the setup.

Log into the personal computer before changing the Network settings, so that the personal computer can communicate with this product. Refer to "2.7.1 Login" for the login method.

**MEMO**

Internet Explorer 11, and Google Chrome, and Firefox is recommended.

### 2.7.1. Login

Various setups for this product is done by logging in from a web browser.

In order to log in, the IP address for this product is entered into the address portion of the web browser. (Refer to "Figure 2.7.1-1", below.)

**<Web Browser Address Input> <http://192.168.10.1/index.htm>**

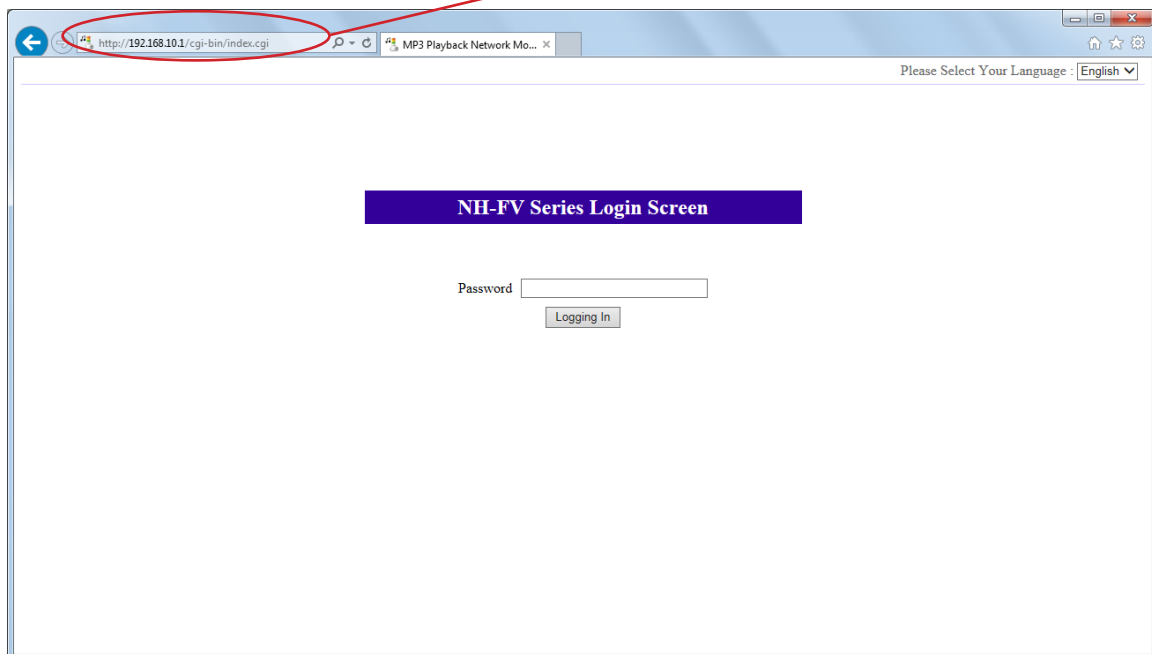

Figure 2.7.1-1 Login Screen

**Attention**

- When the login screen is displayed, enter "patlite" in the password field, then click the "Logging In" button. The default password is set to "patlite". Be sure to change the password to prevent any security breaching.
- If 10 minutes or more of no activity has elapsed after logging in, a time-out causes an automatic log out. When that occurs, log in again.
- If garbled characters occur and the screen is not displayed normally, change the character code for Unicode (UTF-8) to correct it.
- To prevent from being setup in two or more places, this product does not support double-login capabilities. To log in from another location, be sure the last computer is logged out.

**MEMO**

If the login screen is not displayed, refer to "8. Troubleshooting".

When the login screen is displayed, go to the upper right of the screen where "Please Select Your Language" is located to select the preferred language.

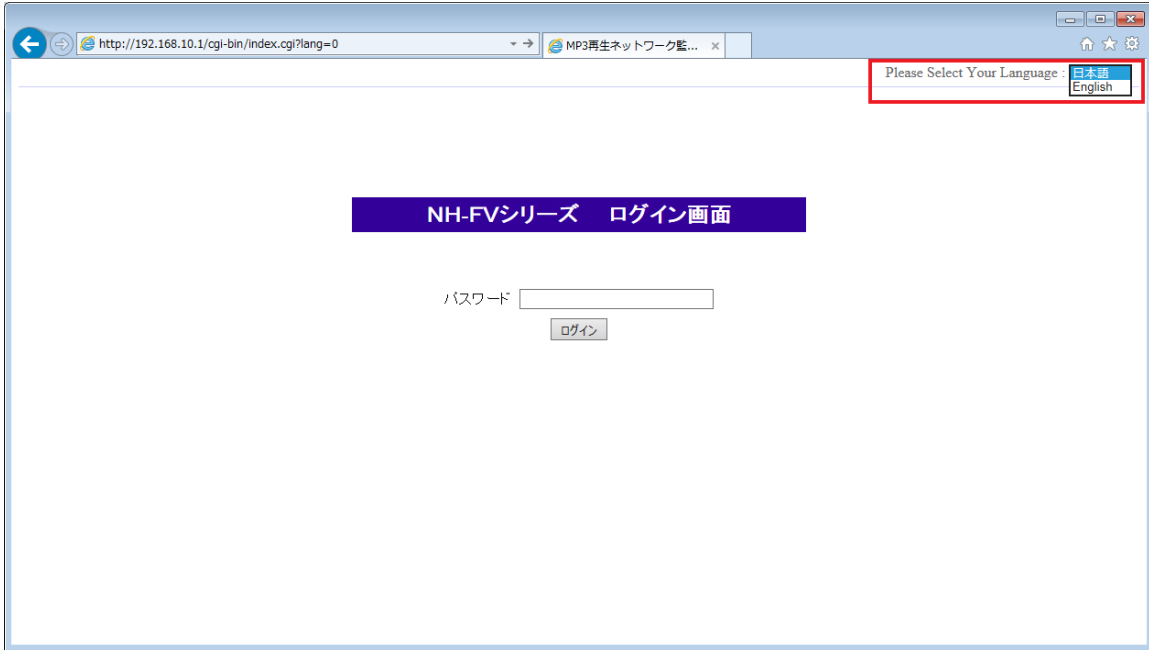

Figure 2.7.1-2 Login Screen

Select the preferred language from the pull down menu in the upper right of the login screen. (Refer to "Figure 2.7.1-2", above.)

The currently selectable languages available are "Japanese" and "English." Once selected, the language will be displayed on each screen in the Web setup tool. (Refer to "Figure 2.7.1-3" and "Figure 2.7.1-4")

When the login screen is displayed, go to the upper right of the screen where "Please Select Your Language" is located to select the preferred language. Enter "patlite" in the password field, then click the "Logging In" button. The default password is set to "patlite." Be sure to change the password to prevent any security breaching.

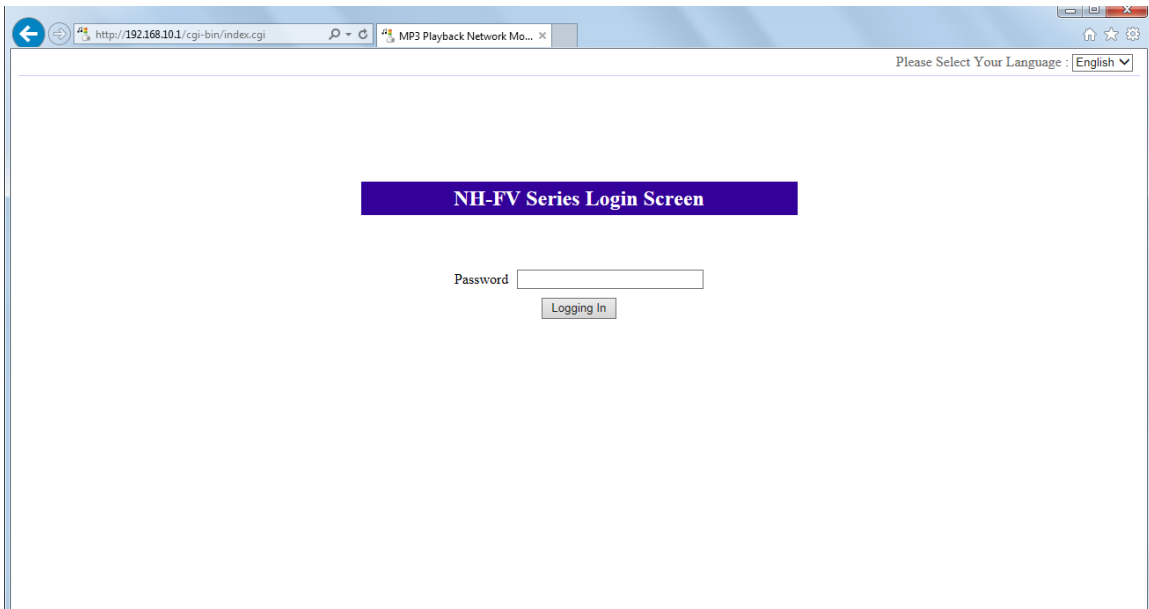

Figure 2.7.1-3 Login Screen (With "English" Selected)



Figure 2.7.1-4 Login Screen (With "Japanese" Selected)

## 2.7.2. Setting the IP Address

After logging in, the web setup tool will be executed and the "System Setup" screen will be displayed. (Refer to "Figure 2.7.2-1")

- ① . Click the "Setup Menu" in the Setup Table Entry on the left-hand side of the setup screen.
- ② . Click "System Setup" from the tree menu. The System Setup Screen is displayed. (Refer to "Figure 2.7.2-2")

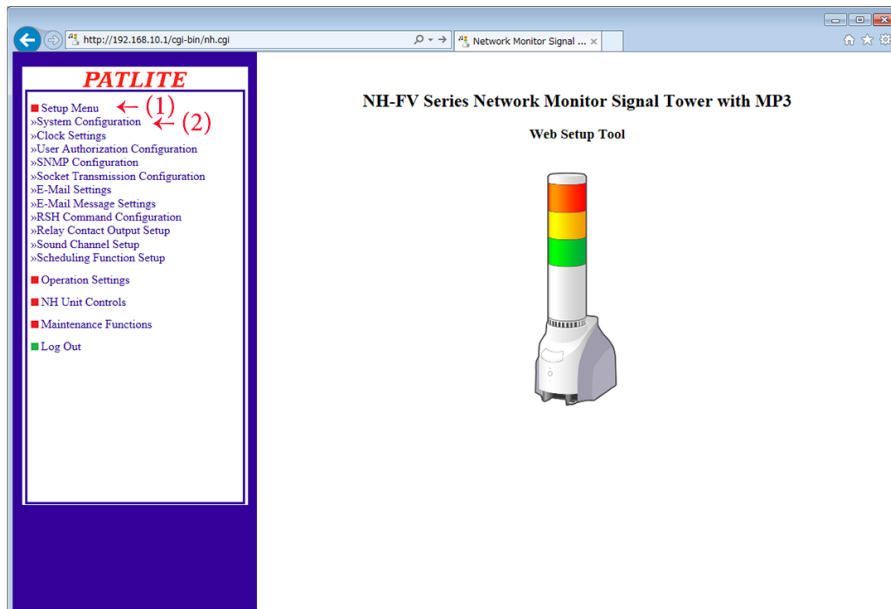

Figure 2.7.2-1 Web Setup Tool Screen

In the System Setup Screen, the network can be changed.

[Setup Method]

- ③ . Enter the Main Unit IP address.
- ④ . Set up the net mask, default gateway, etc. if needed.
- ⑤ . Click the "Set" button to activate the setup.

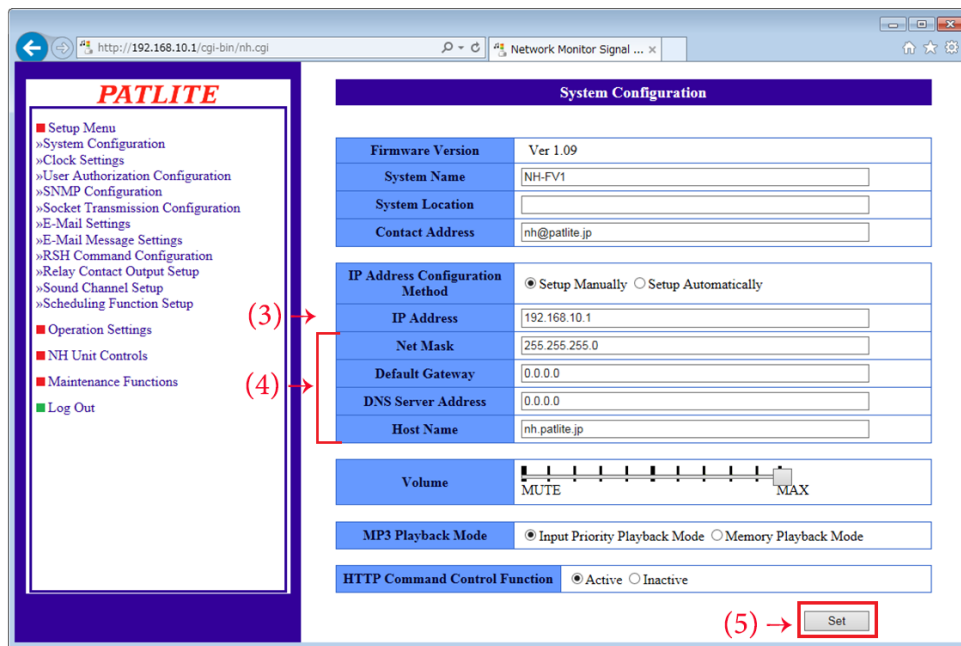

Figure 2.7.2-2 System Setup Screen

- ⑥ . In order to activate the setting parameters, click the "Network Reboot" button. (Refer to "Figure 2.7.2-3")
- ⑦ . Rebooting the network takes about 20 seconds. If no action occurs after time elapses, click "To the Login screen" to log in, again. (Refer to "Figure 2.7.2-3")

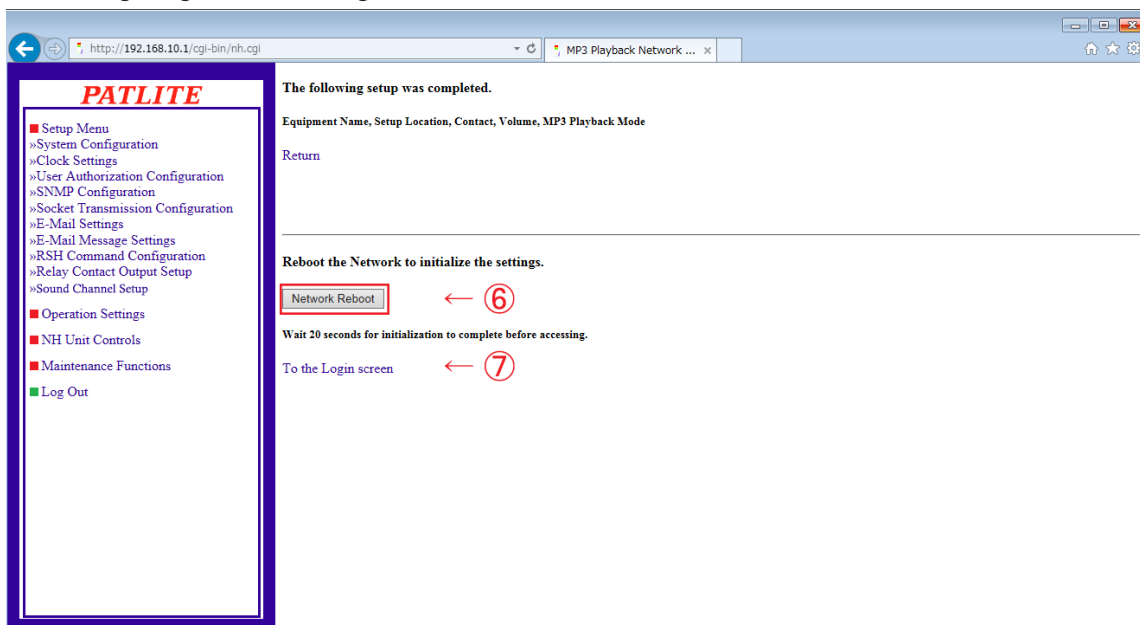

Figure 2.7.2-3 Network Reboot Setup Screen

### 2.7.3. Setup Confirmation

If the web browser address is reflecting the changed value of the IP address after clicking "To the Login screen", the setup of the new IP address has been successful. However, in cases where the preset value of other networks had been changed, be sure to enter the proper IP Address value where it was moved to in order to verify it in the system setup screen.

Verify that the IP Address has changed (Below example shows "192.168.10.1")

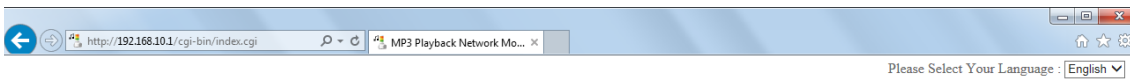

Figure 2.7.3-4 Setup Verification Screen

**MEMO** Depending on the PC network environment, it may be necessary to change the IP address. Even if after logging in and the "System Screen" does not display, Refer to "8 Troubleshooting" for help.

## 2.8. Network Setup with DHCP Function

This product can access a DHCP Server to acquire network information.

There are two methods to enable the DHCP function, one method is to use the Web setup tool and the other method is by operating the switch on the Main Unit. The following will explain the method of enabling the DHCP function from the Web setup tool. Use the following process to set up.

Refer to "3.22 Mode Switch Operating Functions" for enabling the DHCP function with the switch operation from the Main Unit.

Explanation from the setup parameters.

- ① Use the IP address setup method and select "Setup Automatically." (Refer to "Figure 2.8.0-1")
- ② Setup the device and host name, etc. as needed.
- ③ Click the "Set" button to save all changes and to activate them.
- ④ After the "Set" button is clicked, the Web Setup Tool changes to another screen to reboot the product; click the "Network Reboot" icon to continue. (Refer to "Figure 2.8.0-2")
- ⑤ Rebooting the network takes about 20 seconds. Be sure to verify the device names and the IP address of this product with the use of the PNS Manager, etc. before logging in to this product again.

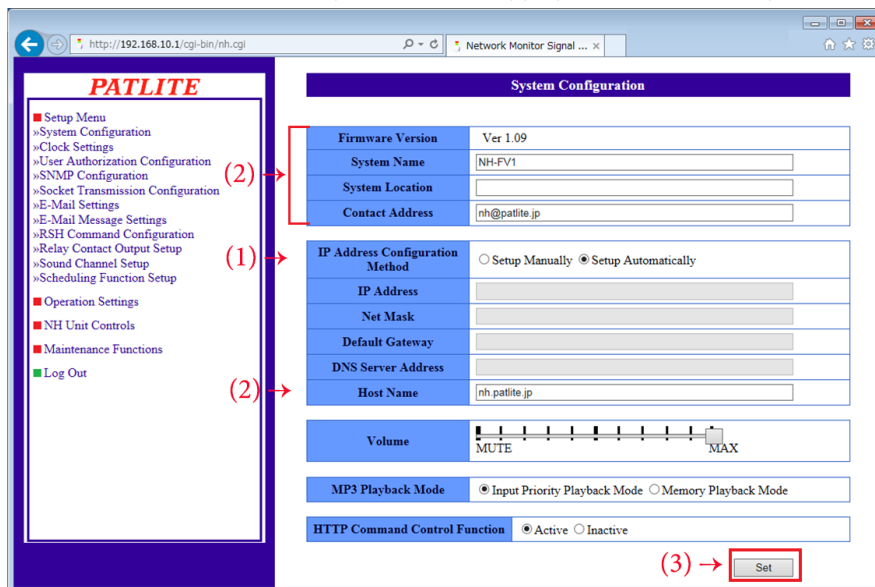

Figure 2.8.0-1 System Configuration Screens (when selecting the DHCP function)

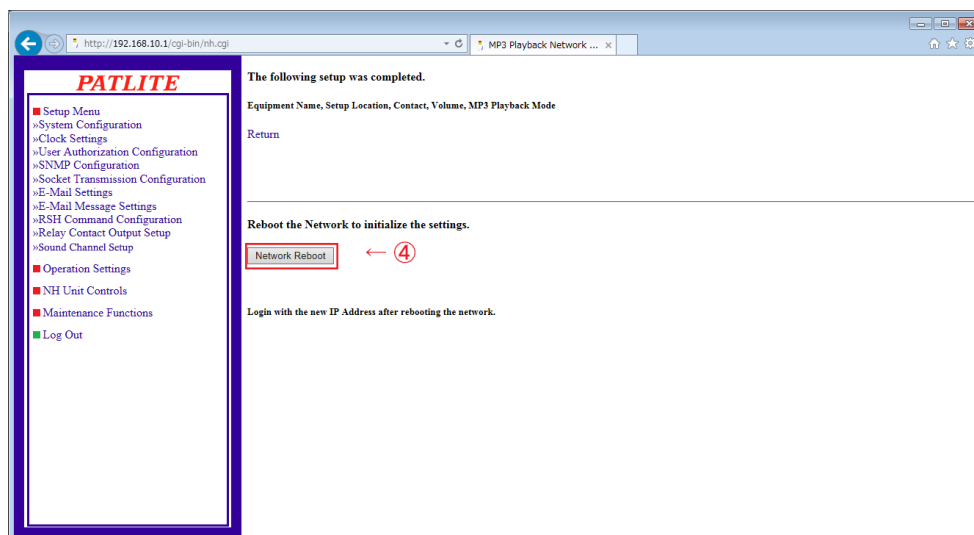

Figure 2.8.0-2 Network Reboot Screen



**Attention**

- If this product is unable to access a DHCP server, it will return to the factory default network information.
- When the DHCP function is set for "Setup Automatically", future connections are started after they have become activated.
- When it is necessary to use the manual settings, please use the Web Setup Tool or the PNS Manager.
- Refer to the "PNS Manager" operation manual for the directions on the PNS Manager.
- When re-connecting with this product after changing the IP address, be sure to change the network setup for the PC if needed..

## 2.9. Operation Setup

### 2.9.1. Clock Setup

The clock for this product can be set up. For setting the clock on this product, the following are two methods.

- Reflect the time of PC which logs in this product.
- Communicate with an NTP server and adjust the time of this product.

Refer to "4.2 Clock Settings Screen" for details on setting the time.

**Attention**

This product uses a capacitor as a battery backup for the time stamp. Depending on the charge status of the capacitor, it may last from about 2 to 3 days and if the power supply is not applied during the day, a gap in time or the need to reset the time may be necessary.  
If an application environment requires a time entry, be sure to set up the time before the application.  
If the backup is depleted and the time entry resets, the set time will be labeled as "Jan 1, 2010".

### 2.9.2. Normal Mode Setup

The normal state of operation of this product can be displayed by using the "Normal Mode" setup. Refer to "4.17 Normal Mode Settings Screen" for the Setup of normal operation status.

**MEMO**

If the normal operating condition does not require any status lights to stay on, then there is no need to set this parameter up.

# 3. Functionality Details

This section explains the available functions of this product, and their differences by the timing charts indicated

## 3.1. MP3 Playback Function

This product can control and play back the MP3 files registered in the internal memory using a digital input or various events. The following explains the MP3 playback function.

### 3.1.1. Playback Event

A playback event is when a status occurs to this product which enables it to reproduce an MP3 file.

This product uses the registered MP3 files built in the unit for a designated channel. The designated channel can play back when an event occurs, based on various functions. The available functions with a playback event and an outline of events are as followed.

Table 3.1.1–1 Playback Event List

Function Name	Playback Event	Outline
Test Function	When pressing "Test" Switch	When running a test, channel 61 (buzzer pattern 1) is played back. Refer to "3.4 Test Function" for details.
Sound Channel Setup Function	When previewing "Sound Setup"	The Web setup tool is used to set up and play back the channel from the loudspeaker inside the Main Unit. Refer to "3.1 MP3 Playback Function" for details. Refer to "4.10 Sound Channel Setup Screen" for setup details.
Socket Reception Function	When receiving PNS Command	A specific channel is played back when a PNS Command is received. Refer to "3.8 PNS Command Reception Function" for details.
Command Reception Function	When receiving RSH Commands	The control of the playback channel can be done by the use of "alert" and "sound" commands. Moreover, the test operation can be controlled by the use of "test" and "dotest" commands, and can control channel 61 (buzzer pattern 1) to play back. Refer to "3.10 RSH Command Function" for details. Refer to "4.8 RSH Command Configuration Screen" for setup details.
SNMP Function	When receiving an SNMP TRAP	A specific channel is played back when an SNMP TRAP is received. Refer to "3.5.3 TRAP Reception Function" for details. Refer to "4.13 TRAP Reception Configuration Screen" for setup details.
Digital Input Function	When the Digital Input status changes	A specific channel is played back when a digital input is turned on or off. Refer to "3.2.2 Digital Input Monitoring Function" for details. Refer to "4.12 Digital Input Setup Screen" for setup details.
Digital Input Condition Function	When the Digital Input Condition agrees	A specific channel is played back when the conditions agree with the digital input setup. Refer to "3.12 Application Monitoring Function" for details. Refer to "4.15 Application Monitoring Configuration Screen" for a Setup.
Ping Monitoring Function	Monitoring for abnormal/restore condition	A specific channel is played back in correspondence to the abnormalities or restoration of an object being monitored. Refer to "3.11 Ping Monitoring Function" for details. Refer to "4.14 Ping Monitoring Configuration Screen" for Setup details.
Application Monitoring Function	Monitoring for abnormal/restore condition	A specific channel is played back in correspondence to the abnormalities or restoration of an object being monitored. Refer to "3.12 Application Monitoring Function" for details. Refer to "4.15 Application Monitoring Configuration Screen" for setup details.
SNMP Supported Monitor Function	Monitoring target when conditions agree/when conditions are restored/when changes are detected	A specific channel is played back in correspondence to conditions that agree, are restored, or when changes occur. Refer to "3.6 SNMP Supported Equipment Monitor Function" for details. Refer to "4.21 SNMP Supported Equipment Monitor-Detection Screen 1" for Setup details, or refer to "4.22 SNMP Supported Equipment Monitor-Detection Screen 2" on pg. 146.
SLMP Read Command Transmission Function	SLMP Command Condition Agreement SLMP Command Error	The received SLMP command has to agree with conditions, or the specified channel will play back when an error is detected. Refer to "4.19 SLMP Read Command Configuration Screen" for Setup details.
HTTP Command Control Function	When receiving HTTP Commands	The control of the playback channel can be done by the use of "alert" and "sound" commands. Refer to "3.25 HTTP Command Control Function"

### 3.1.2.Channel

This product has two different methods for MP3 file registration, one is the use of registering with creating a Playlist Package with the PATLITE Playlist Editor 2, or registering through the web setup tool.

This product has 70 channels numbered from 1-70, and is roughly divided into three categories as followed.

Channels 1-30 The range of channels which can be registered with creating a Playlist Package.

Channels 31-60 The range of channels which can directly register an MP3 file from the web setup tool.

Channels 61-70 The range of channels which are pre-registered MP3 files made at the time of shipment.

Below describes the channel format.

**Attention**

Preset Channels cannot be erased or changed.

#### << Playlist Package registered MP3 files >>

The MP3 file registered from the "Playlist Package" is set up with the "PATLITE Playlist Editor 2" in the "setting frame", which can be registered as a "channel", with setting options for Repeat Playback, volume and the number of blank seconds maintained after the message was played.

Refer to "3.21 USB Memory Function" on how to register a "Playlist Package" to this product.

Refer to the "PATLITE Playlist Editor 2" operation manual for how to use the "PATLITE Playlist Editor 2."

Table 3.1.2-1 Playlist Package Layout

Channel	Setup Frame 01	Setup Frame 02	Setup Frames 03-15	Setup Frame 16
Channel 1	Repeat Cycles Time of Sound & Silence	Repeat Cycles Time of Sound & Silence	Repeat Cycles Time of Sound & Silence	Repeat Cycles Time of Sound & Silence
Channel 2	Repeat Cycles Time of Sound & Silence	Repeat Cycles Time of Sound & Silence	Repeat Cycles Time of Sound & Silence	Repeat Cycles Time of Sound & Silence
<b>Channels 3-29</b>	Repeat Cycles Time of Sound & Silence	Repeat Cycles Time of Sound & Silence	Repeat Cycles Time of Sound & Silence	Repeat Cycles Time of Sound & Silence
Channel 30	Repeat Cycles Time of Sound & Silence	Repeat Cycles Time of Sound & Silence	Repeat Cycles Time of Sound & Silence	Repeat Cycles Time of Sound & Silence

**Attention**

Rearrange the channels in the Playlist Package with the "PATLITE Playlist Editor 2" for functions like deleting or editing channels before registering them to this product. Only a title can be changed in the web setup tool.

#### << Registering MP3 Files from Web Setup Tool >>

From the voice channel setting screen in the Web setup tool, 1 MP3 file can be registered per channel.

Refer to "4.10.2 Web Setup Data (Ch31-Ch40, Ch41-Ch50, Ch51 - Ch60)" for the details on the registration method.

Table 3.1.2-2 MP3 Files for Channels 31-60

Channel	MP3 File
31	1
32	2
33-58	3-28
59	29
60	30

### 3.1.3. Playback Pattern

Each channel can have a playback pattern set up for a playback event.

There are three playback patterns which can be set up with this product.

Refer to "4 Function Setup" for further details on the explanation in the setup screen for each function.

#### (1) "One-shot Playback"

The channel is played back once per playback event. No playback is repeated.

#### (2) "Repeat playback (Stops after specified number of times)"

The channel only plays back when set up to play a certain number of times per playback event.

If the repeat playback is set where it plays only 1 time, the channel is repeatedly played back twice (1+1).

If the repeat playback is set where it plays 0 times, the channel will play back only once, the same operation as a one shot playback.

If the repeat playback is set where it plays 255 times, the channel will play back the same as an endless playback.

#### (3) "Repeat Playback (Endless)"

The channel will play back repeatedly per playback event.

#### Attention

- When both the PATLITE Playlist Editor 2 Repeat Playback and playback pattern setup are made, the number of times for playback is as follows.

"Number of playback times" =

"PATLITE Playlist Editor repeat playback +1" multiplied by the "Repeat Playback cycles"

- If a Repeat Playback is made "infinite" with the PATLITE Playlist Editor 2, it is unrelated to the playback pattern setup and becomes an endless playback.
- The playback pattern for channel 61 (buzzer pattern 1) through channel 64 (buzzer pattern 4) is fixed as an endless playback.

### 3.1.4. Master Volume Function

Sound reduction for all the channels in the playback events are done together. Sliding the "volume" in the Web setup tool System Setup, the playback volume sound reduction and signal level for the Main Unit loudspeaker and lineout is controlled. Refer to "4.1 System Configuration Screen" for further details of the operation method.

#### Attention

The setup for the playback volume from the Main Unit loudspeaker is in the following order, and sound reduction is from the original volume.

##### (1) Master Volume Setup

With the volume from the MP3 file at its maximum, the minimum can be reduced down to MUTE.

##### (2) Playlist Package (only channels 1-30) Volume Setup

The master volume is made at its maximum (0), and sound reduction can be controlled to a minimum (FF) in 256 steps.

##### (3) Main Unit "volume knob" setup

If the volume setup for the above-mentioned (1) and (2) is made for maximum, the minimum can be reduced down to MUTE.

If any one of the setups where sound reduction is at its maximum, even if each setup is different, keep in mind that the sounds set for minimum may cause the playback volume to become extremely small, or silent.

### 3.1.5. Lineout Function

When a channel is played back during a playback event, the signal output can be taken from the lineout on the back of the Main Unit.

The lineout active/inactive setting can be made from the "Web Setup Tool", and each channel can be set, so the required "channel output" can be sent to the lineout.

The specifications for a signal lineout is as followed.

< Lineout Signal Specifications >

Signal level: 0 dBv 600 Ω connection, sinusoidal wave playback

Sound Channel Type: 1 ch (monaural recording)

Connector Type: Mini-jack

**Attention**

- If the BUSY output function for the relay contact output setup is used, a time delay can be set up for sending a signal output from the lineout during a playback event. Refer to "3.2.4 Relay Contact Output Control Function" for details.
- Do not connect headphones to the lineout.  
Connect a speaker with a built-in amplifier, or equipment corresponding to the line-in specifications.
- A monoraul type plug should be used for the lineout.
- In cases where a stereo mini plug is used, the signal output is only from the left channel.
- If the MP3 file is registered in stereo sound, then the Main Unit speaker plays back the Left channel of the MP3 file, and the line-out plays the Right channel.
- No preset channels can be played through the lineout.  
It only plays back through the Main Unit loudspeaker.
- The lineout volume setup is based on the master volume.

### 3.1.6. MP3 File Registration

The MP3 file formats which can be registered into this product requires the following specifications.

#### MP3 File Format Compatibility

Format	: MPEG1-Audio Layer III (MP3)
Bit Rate	: Set Bit Rate (CBR) 32kbit, 64kbit, 128kbit/s
Sample Frequency	: 44.1kHz - 48kHz
Sound Channel Type	: 1ch (Monaural)
Registrable File Size	: Total of 30MB ( Playlist Package Size: 10MB, Web Setup Tool Size: 20MB )

**Attention**

- MPEG-2 Audio Layer-3 (MPEG-2 AudioBC) format does not guarantee any playback operation.
- This product does not correspond the MP3 extended formats (PRO/Surround/HD).
- A more than 160k bps file cannot be uploaded by a constant bit rate.
- Playback of encoded MP3 files not compatible with the fixed bit rate for this product are not guaranteed.
- If the MP3 file is registered in stereo sound, then the Main Unit speaker plays back the Left channel of the MP3 file, and the line-out plays the Right channel.

#### <<MP3 File Registration Method >>

There are two methods to register an MP3 file into this product:

- (1) Using a USB memory to register a Playlist Package.
- (2) Directly registering an MP3 file from the "Web Setup Tool."

#### (1) Registering a Playlist Package Using USB Memory

PATLITE Playlist Editor 2 can be used and the Playlist Package created for these products can be registered into the Main Unit using a USB memory.

After registering a Playlist Package, a title can be assigned for every channel from the "Web setup tool".

The maximum number of registration channels is 30, from channels 1-30. Refer to "3.21 USB Memory Function" for details.

**Attention**

- If a "playlist file (.slp form)" is registered, change it into a Playlist Package (.pkg form) for the PATLITE Playlist Editor 2.
- Any files outside the Playlist Package created for This products can not be registered.
- The maximum file size which can be registered in a Playlist Package is 10MB.
- If the Playlist Package is registered in stereo sound, then the Main Unit speaker plays back the Left channel of the MP3 file, and the lineout plays the Right channel.

#### (2) Registering an MP3 file from the "Web Setup Tool"

From the "Web Setup Tool" screen, an MP3 file can be selected and registered with the Main Unit.

A "title" can be assigned for every channel when registering.

The maximum number of registrations is 30, and only for channels 31-60.

Refer to "4.10 Sound Channel Setup Screen" for details.

**Attention**

- A maximum file size of 20MB can be registered.
- MP3 files containing ID tags etc., does not guarantee playback operation. When registering an MP3 file, delete ID tag data, etc., from an MP3 file before registering. In addition, when this product uploads an MP3 file, it automatically deletes ID3 v1, ID3 v2, and APE formatted tags. MP3 files containing these tags can be uploaded as is.

### 3.1.7. Playback Mode

This product can be selected for input priority playback mode or memory playback mode.  
Refer to "4.1 System Configuration Screen" for further details of the operation method.

#### << Input Priority Playback Mode >>

If a new playback event occurs, the channel being played back will be interrupted and a new channel will play.

When the event operation timing and channel playback are synchronized, simultaneously use the generation of an event with channel playback.

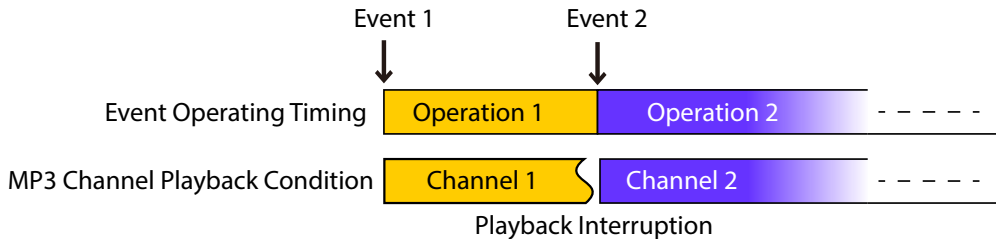

#### << Memory Playback Mode (Channels 61-64 not included) >>

During Playback	Playback Event
Anything outside buzzer patterns	Anything outside buzzer patterns

If a new playback event occurs, the channel number to be played back will be registered into the channel memory.

When playback is ended, the next available channel stored in memory will play.

Use this feature to keep track of setting up the order in which channels to playback, and the number of times to playback channels.

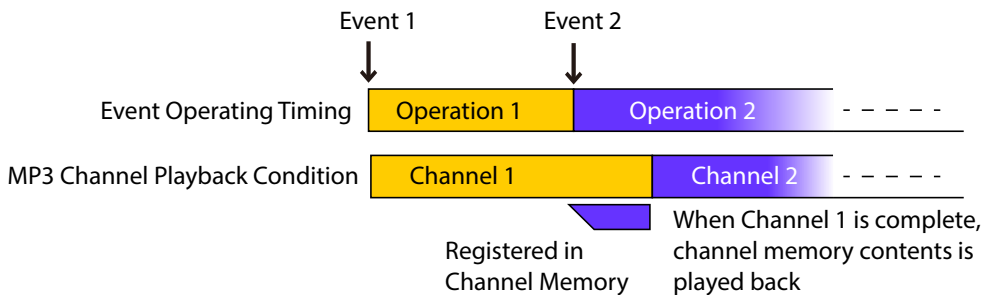

#### Attention

- The maximum number to register channel memory is 5 channels. If 5 channels are exceeded, any new channels will not be registered into the channel memory, and will be ignored. However, any set up for operation (Signal Tower, e-mail, TRAP transmission, etc.) events will be executed.
- A delay can be produced in the memory playback mode for channel playback timing and executing the timing of event operations.

## << Memory Playback Mode (Channels 61-64 included) >>

In << Memory Playback Mode ( Channel 61-64 included >>, operations containing channels 61-64 (buzzer patterns 1-4) for preset channels has different operations from other channels.

### (1) When a playback event occurs during channels 61 - 64 (buzzer patterns 1-4) playbacks

While a buzzer pattern is in playback, two different kind of playback events (event 2) occur.

	During Playback	Playback Event
(A)	Buzzer Patterns 1-4	Anything outside buzzer patterns
(B)	Buzzer Patterns 1-4	Buzzer Pattern

#### (A) Creating playback events outside channels 61 - 64 (buzzer pattern 1-4)

The buzzer pattern continues during playback and event 2 is registered into channel memory. Since playback is set for endless repeat, in order to play back event 2 in channel memory, the buzzer pattern needs to operate under one of the following methods:

- By going to the "music sending" and push the "Clear" switch to clear the operation setting.
- By using an RSH Command to execute the "STOP" command.

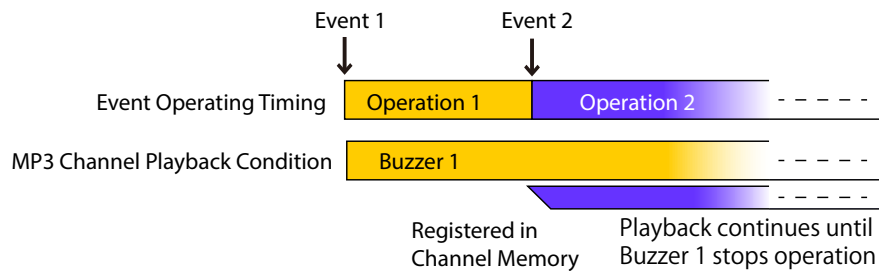

#### (B) Creating playback events within channels 61 - 64 (buzzer pattern 1-4)

Other channels can interrupt the channel during playback and reproduce buzzer 2 and interrupt event 2 immediately during playback, without having to register a channel memory. Then all channels registered in the channel memory that start at playback are erased.

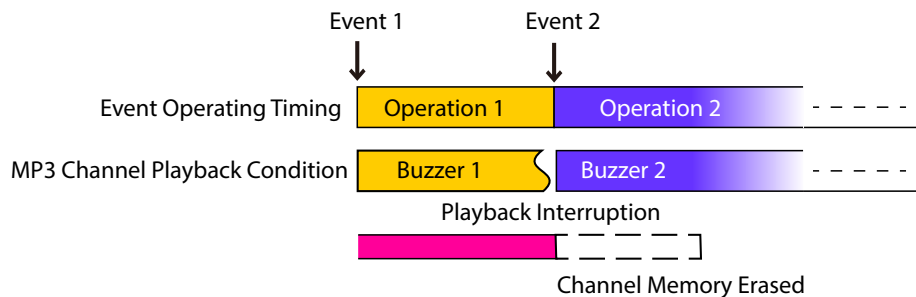

### (2) When channels outside Channels 61 - 64 are in playback and a playback event from channels 61-64 (Buzzer Patterns 1-4) occurs

During Playback	Playback Event
Anything outside buzzer patterns	Buzzer Patterns 1-4

While channels outside Channels 61-64 are in playback, Channels 61-64 (Buzzer Pattern) can interrupt the channel during its playback without having to register with a channel memory, and playback immediately. Then all channels registered in the channel memory that start at playback are erased.

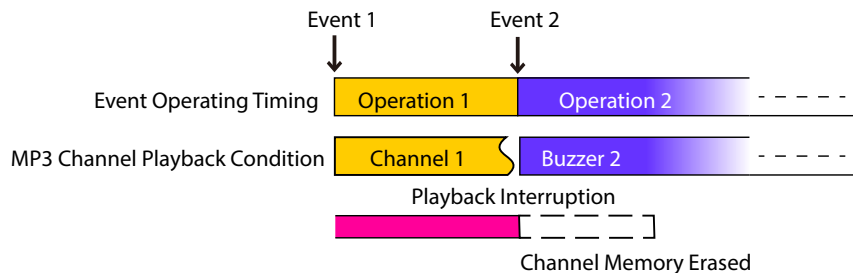

### 3.1.8. Preset Channel

Ten kinds of sound data are pre-registered as preset channels, so that this product can be used immediately after purchase. The "preset channel" structure is as followed:

< Preset Channel List >

Channel 61 - 64 : Buzzer Pattern 1-4

Channel 65 - 67 : 3 Melody Selections

Channel 68 - 70 : 3 Message Selections

#### << Channels 61 - 64 (Buzzer Pattern 1-4) >>

The following buzzer sound patterns are reproduced. Playback continuation occurs when the one shot playback is selected. It is played back automatically in synchronization with the blinking cycle of the Signal Tower.

Buzzer Pattern 1



Buzzer Pattern 2



Buzzer Pattern 3

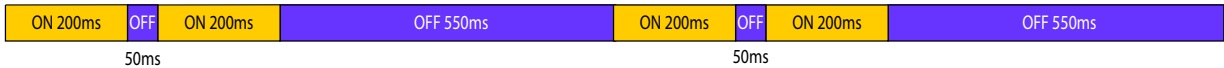

Buzzer Pattern 4



#### << Channels 65 - 70 (3 Melody, 3 Message Selections) >>

The melody and message which are registered into this product beforehand are as followed.

Table 3.1.8-1 Preset Melody and Message Channels

Channel Number	Contents
65	Chime 1
66	Chime 2
67	Chime 3
68	Abnormality detected in Network
69	Abnormality detected
70	Abnormality cancelled

**Attention**

- A preset channel is played back only from the Main Unit loudspeaker. It cannot be used with the lineout function.
- The preset channels cannot be deleted or changed.



## 3.2. Digital Input Function

This product can monitor or control the status of four digital input ports and one digital output port. This function can set up various operations automatically, when changed to the status of each designated input/output port. The following explains the input/output function.

### 3.2.1. Digital Contact

The following explains the definition of the point of contact status for the digital input or output in this product. When the "A" contact ("Contact A") is closed, it is recognized to be "ON". When the "B" contact ("Contact B") is open, it is recognized to be "ON". For example, a button switch may use "Contact A" as a point of contact (if the switch is pushed, the point of contact will close and is set to "ON"), and a motion sensor (if motion is detected and the electricity goes out, the point of contact has closed, electricity turns on and it is recognized as "ON") becomes a "B Contact". It may be called "Contact A" and "Contact B".

Table 3.2.1-1 Digital input/output Contact Point Status

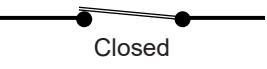
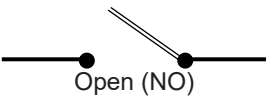
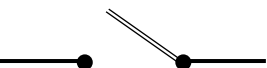
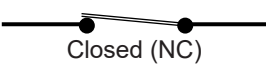
Operating Condition		ON	OFF	Comment
Digital Logic		1 (01H)	0 (00H)	
Contact Condition	Contact A (Make Contact) (Normally Open)	 Closed	 Open (NO)	When in the "OFF" condition, open contacts means no current flow. When in the "ON" condition, contacts make and allows current to flow.
	Contact B (Break Contact) (Normally Closed)	 Open	 Closed (NC)	When in the "OFF" condition, contacts allow current flow in its normal condition. When in the "ON" condition, contacts are open and not allowing contact flow.

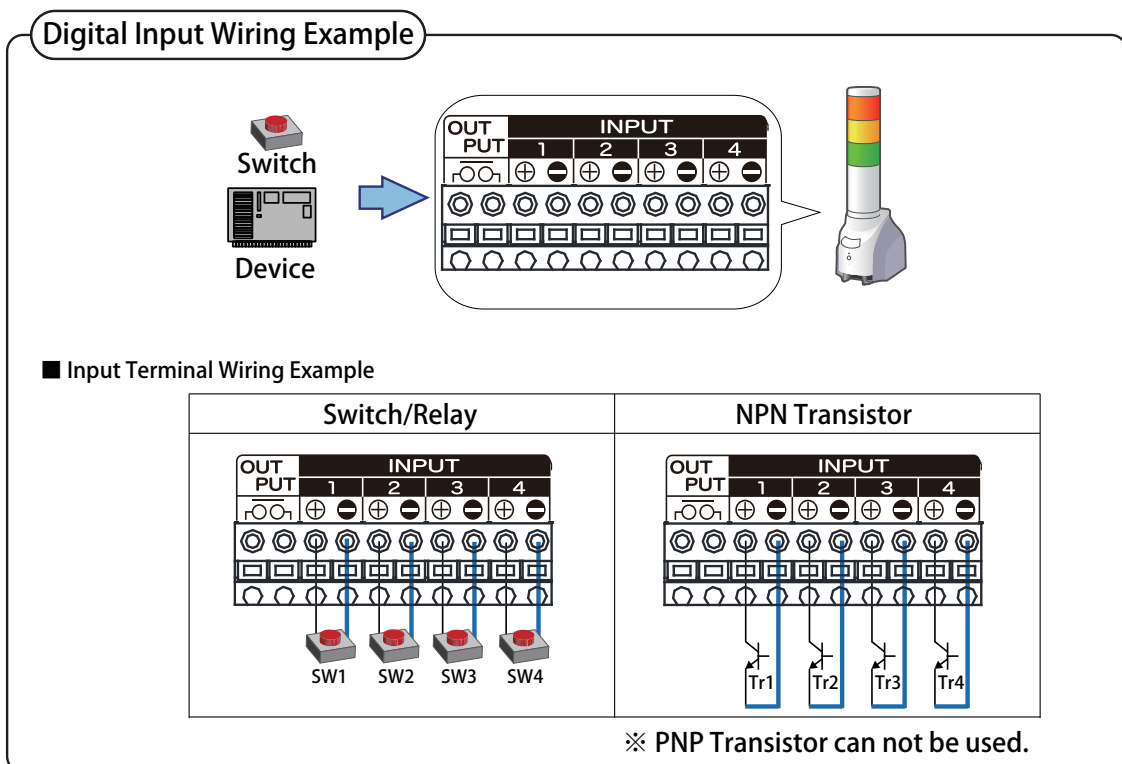

Figure 3.2.1-1 Digital Input Wiring Example

### Digital Output Wiring Example

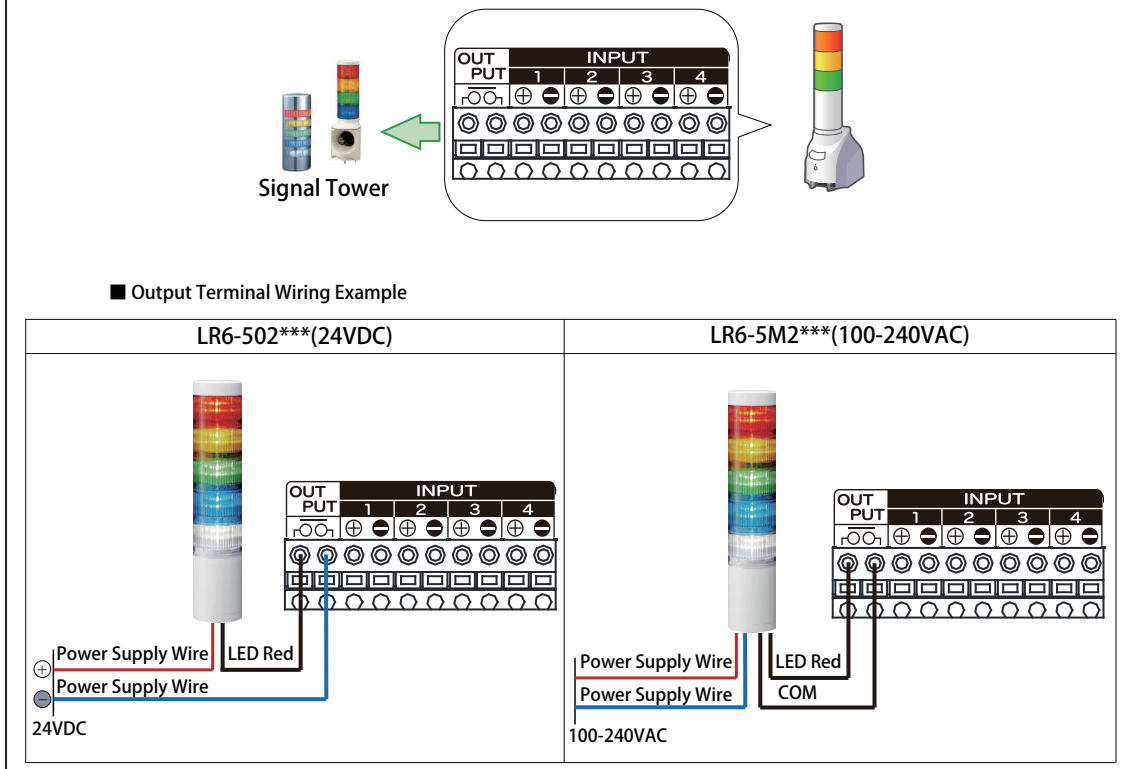

Figure 3.2.1-2 Digital Output Wiring Example

### 3.2.2. Digital Input Monitoring Function

With the digital input monitoring function, the digital signal entered into the four port input terminal is monitored with a regular interval as a digital input. The digital input can be designated to be used in the digital logic setup as a point of contact for the "A Contact" or "B Contact", with a definition for every signal port. In cases where the digital input status change is detected, various controls can be done according to the setup for each port.

In this product, an input trigger can have each digital input port as a signal definition based on conditions set up. The timing for this operation can be created when the digital input status changes. Below, the "A Contact" digital input signal definition for this product is explained.

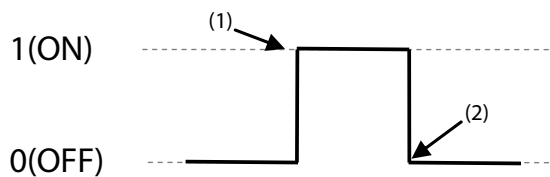

Figure 3.2.2-3 Digital Input Signal Operation

Table 3.2.2-1 Status Change Definition of Digital Input Signal

ON Change	When a digital input is set to ON (1), it judges that the status change occurred, and it is controlled according to its setup.
OFF Change	When a digital input is set to OFF (2), it judges that the status change occurred, and it is controlled according to its setup.
Transition	When a digital input is ON (1) or OFF (2), it judges that the status change has occurred, and it is controlled according to their individual setup conditions.

The digital input monitor operation setup can be accessed through the "digital input setup" in "Table 4.12.3-1 Digital Input Setup Parameters" from the Web setup tool. For details, refer to "4.12 Digital Input Setup Screen" on pg. 122.

**MEMO**

- The digital input monitor cycle is 110 ms. In order to determine a stable detection, the input signal has to be maintained for greater than 110 ms of an input signal status change.
- In cases where the digital input status change continues to be constantly changing, the internal management may stop determining a change in status and a delay may happen during operation. If the control content has too many stagnate fixed numbers, any new control contents produced is canceled and will not operate.
- Be sure to have sufficient operation confirmation before applying and setting up the operation to trigger the delays and monitoring of the digital input signal.

### 3.2.3. Digital Input Circuit Diagram

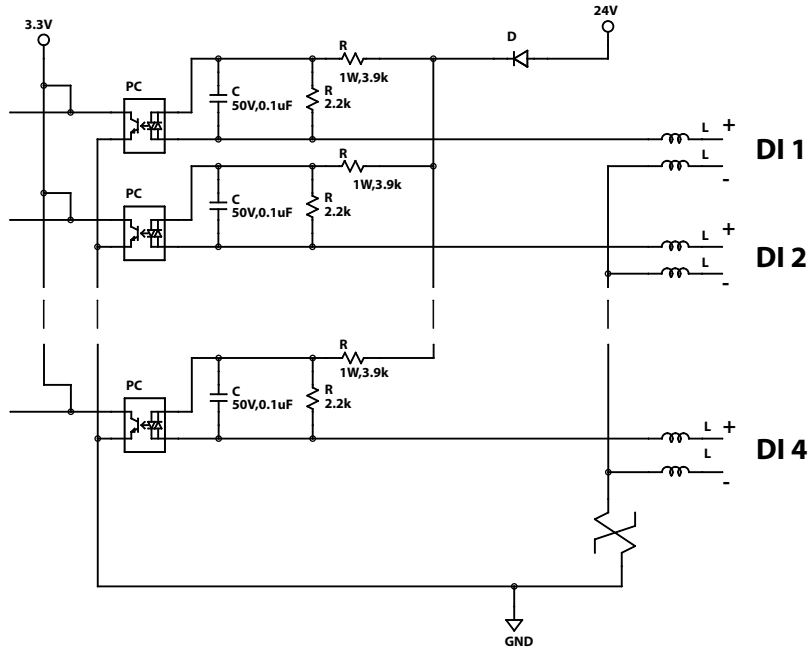
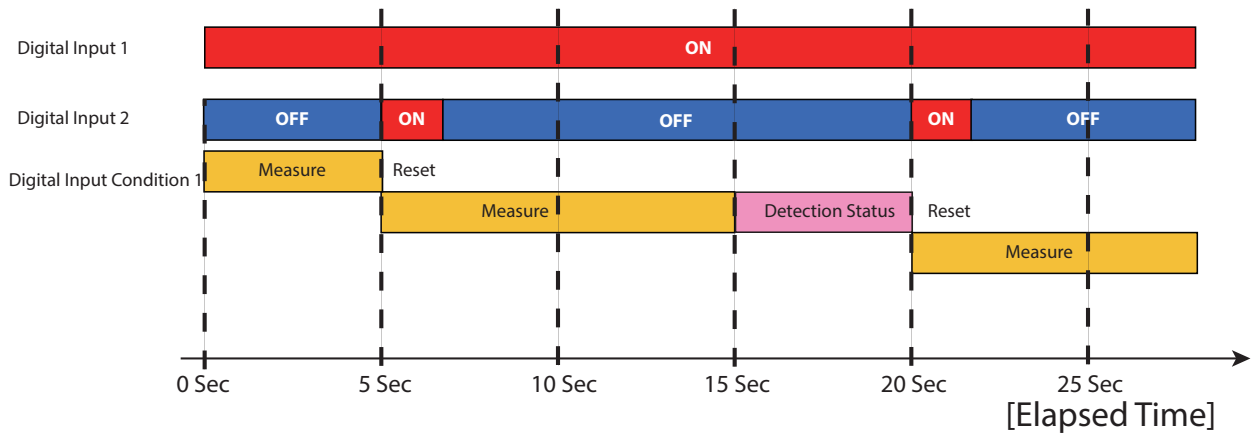

Figure 3.2.3-4 Digital Input Circuit Diagram

### 3.2.4. Digital Input Condition Setup for “Clear” Function

Using the "Digital Input Condition Setup", a duration can be set for a "Clear Condition" to cause a reset, thus controlling a digital input.

The duration of the "Digital Input Condition 1" Setup is set to measure 10 seconds; then, when digital input 2 turns ON, it's condition is set for "Clear Condition" and causes "Digital Input Condition 1" to reset, toggling Digital Input 2.



### 3.2.5. Relay Contact Output Control Function

This product has one relay contact output terminal port in the back. By connecting the output terminal mount to the equipment which has a contact input, a variety of conditions can be controlled from this product. A difference in the event and method of controlling the output terminal relay contact has two modes, "digital output mode" and "BUSY output mode".

#### << Digital Output Mode >>

In the digital output mode, various events can cause a trigger to control one output terminal relay contact port. The digital "A Contact" or "B Contact" output for an automatic OFF function of the digital output port can be set up.

<b>MEMO</b>	<ul style="list-style-type: none"> <li>• The digital output status takes effect on the output terminal every 100 ms.</li> <li>• When the digital output mode is selected, the BUSY output mode cannot be used. Use the Web setup tool to change the relay contact output in the setting screen.</li> </ul>
-------------	--

The digital output port can be operated by the following functions.

Table 3.2.5-1 Output Event List

Function Name	Operation Event	Outline
Socket Reception Function	Received PNS Command	It can be operated by an identifier "D" command. Refer to "3.8 PNS Command Reception Function" for details.
Command Reception Function	Received RSH Command	It can be operated by the "alert do" command. Refer to "3.10 RSH Command Function" for details.
SNMP Function	Received SNMP Set Command	OID can be designated and operated by setting a value. Refer to "4.4 SNMP Configuration Screen" for details.
SNMP Function	Received TRAP	It can be operated during a TRAP reception. Refer to "4.13 TRAP Reception Configuration Screen" for details.
Digital Input Monitoring Function	When the digital input status changes	It can be operated when a digital input status changes. Refer to "4.12 Digital Input Setup Screen" for details.
Digital Input Condition Function	When the digital input condition agrees	It can be operated when conditions agree. Refer to "4.23 Digital Input Condition Settings Screen" for details.
Ping Monitoring Function	Monitoring object abnormal/restore	It can be operated from the monitor abnormality and restoration function. Refer to "4.14 Ping Monitoring Configuration Screen" for details.
Monitoring Application Function	Monitoring object abnormal/restore	It can be operated from the monitor abnormality and restoration function. Refer to "4.15 Application Monitoring Configuration Screen" for details.
SNMP Supported Equipment Monitor Function	Monitoring Object Status: When conditions agree/When conditions are cancelled/When changes are detected	It transmits at the time of condition agreement, condition cancel, and change detection. Refer to "4.21 SNMP Supported Equipment Monitor-Detection Screen 1" for details, or refer to "4.22 SNMP Supported Equipment Monitor-Detection Screen 2"
SLMP Read Command Transmission Function	SLMP Command Condition Agreement SLMP Command Error	It can be operated by a condition agreement. Refer to "4.19 SLMP Read Command Configuration Screen" for details.
HTTP Command Control Function	Received HTTP Command	It can be operated by the "output" command. Refer to "3.25 HTTP Command Control Function"

## << BUSY Output Mode >>

The "BUSY output" mode is a function which controls the relay contact output in conjunction with the signal output from the line-out. While a signal output comes from the lineout, the output terminal is closed. While a signal output is coming from the lineout, the output terminal is open. Moreover, the build up time of the equipment of the connection destination of line-out, etc. are taken into consideration, and it is an output terminal mount previously at the time of channel playback. Since it closes and a channel regenerative signal is outputted later, the Setup of "Output delay time" can be performed. Refer to "4.9 Relay Contact Output Setup Screen" for the "BUSY output" setup.

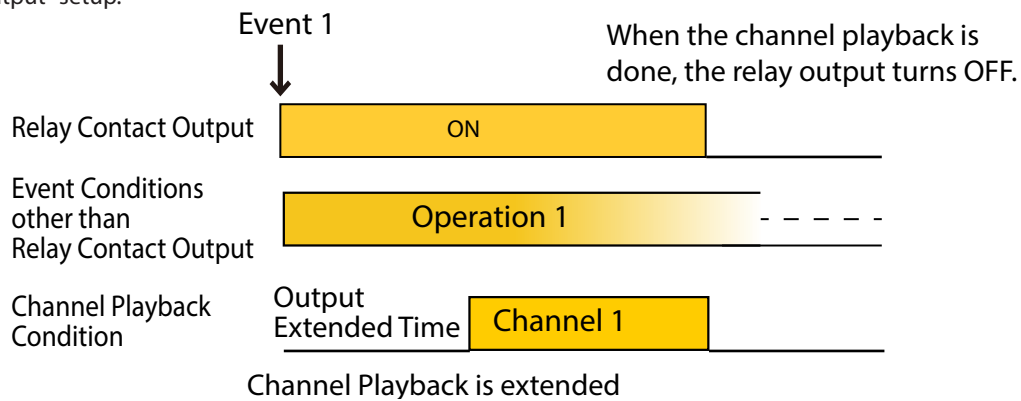

### Attention

- When the "BUSY output" is set, the RSH, PNS operation commands for the relay contact output cannot be used.
- The "BUSY Output" does not operate while the preset channels (Channels 61-70) are played back.
- The "BUSY output" is fixed for the "A Contact". The "B Contact" cannot be used.
- When a playback event occurs during an output delay in the input priority playback mode, output delay time is canceled and the next playback channel event is reproduced.
- In the memory playback mode, an output delay only occurs after the channel is reproduced first. Output delay is not used for the memory playback mode. A BUSY output also stays in the ON status during playback.
- After playback termination of a channel, if an event occurs within 1 second, causing a channel to be reproduced, the BUSY output will stay in the ON condition. Although the channel playback will be reproduced, there will be no output delay.

### 3.2.6. Automatic Digital Output OFF Function

This function maintains an ON status digital output in seconds, when used with the Web setup tool, after receiving the signal which changes the digital output into a digital logic ON status value. If another ON signal is received during an automatic OFF setup time, the automatic OFF setup time will be reset, so the digital output signal ON status will be extended.

However, if the automatic OFF setup time is set as 0 seconds, then the automatic OFF function will become invalid.

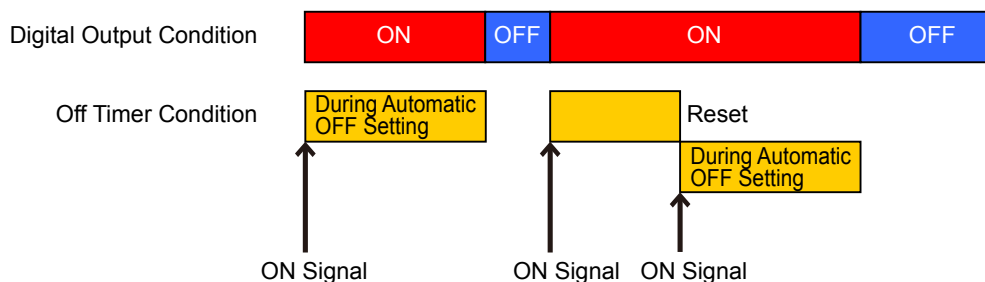

### 3.2.7. Relay Contact Output Circuit Diagram

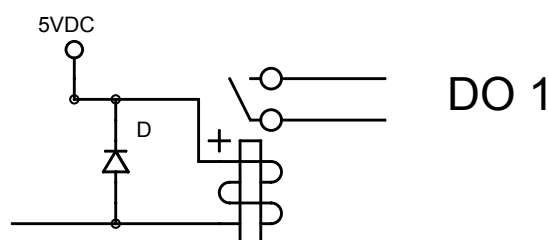

Figure 3.2.7-1 Relay Contact Output Circuit Diagram

### 3.3. Signal Tower Control Functions

With digital input events and receiving various control commands, such things as Signal Tower lighting, flashing, and turning out lights can be controlled. Signal Tower Lighting and flashing patterns are as followed.

Lighting



Flashing Pattern 1



Flashing Pattern 2

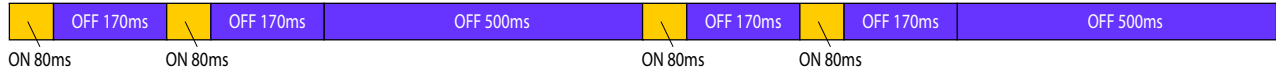

## 3.4. Test Function

A test function is a function to turn on a Signal Tower light, one by one with red, yellow, green, etc., as shown in "Figure 3.4.0-1 Test Operation Detailed Drawing", to confirm proper operation.

When a test function is performed, the Signal Tower sequentially turns on every other second to test functions from the LED units, until channel 61 (Buzzer Pattern 1). During the execution of the test function, it cannot be stopped. Channel 61 (Buzzer Pattern 1) After a buzzer sound is made and 1 more second or so is elapsed, all the Signal Tower lights turn off and the buzzer sound stops.

[Test Function Starting Method]

- When the "test" or "dotest" commands are sent by the RSH command.
- When the "TEST" button is pressed.

After completing a test function, turning Signal Tower lights off and stopping the buzzer sound can be done by the following method:

- Press the "CLEAR" switch
- Send an RSH "clear" or "doclear" command
- Use An SNMP function to clear.
- Use the Web setup tool to execute a "clear" operation from the Signal-Tower operation screen.
- Sending a "Clear" command transmission from a PNS Command.
- Send an HTTP "clear" command.

If a test is executed, the stop playback will first be terminated if all Signal Towers are reproducing channels 61 - 64 (buzzer patterns 1-4), then all lights will be turned off.

An operation stop can be carried out henceforth from this which is the completion of execution of a test function here.

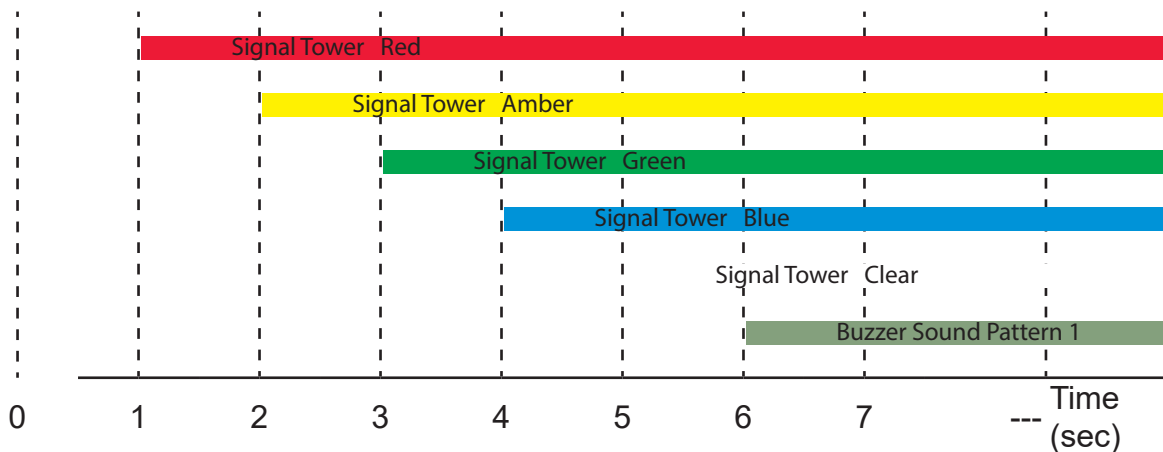

Figure 3.4.0-1 Test Operation Detailed Drawing

### Attention

- Executing a test will operate the Signal Tower. If the test is executed while in use, be sure to check that it is enough for satisfactory conditions.
- Even during the Execution of a test, the monitoring function is still operating. Be careful when executing a test to confirm operation of this product.
- A test execution can be done during and after the return of an abnormal acknowledge in a PHN Command and PNS Command. A BUSY acknowledge is also returned by the RSH command.
- After the test execution is completed, the monitoring function can usually be done through the operation of the Signal Tower.
- To stop a test execution, refer to "3.15 "Clear" Operation Function" for details.
- Executing the test operation will Clear any channel memory.

## 3.5. SNMP Function

This product can control the Signal Tower and channel playback, as well as acquisition the status, and TRAP reception using the SNMP functions.

For customers who purchased this product, download the MIB file for use with the SNMP functions. For further details, Refer to "5 MIB" regarding the MIB.

For further details on the setting method, refer to "4.4 SNMP Configuration Screen" on pg. 107.

### MEMO

Refer to "8 Troubleshooting" for diagnosing issues before requesting customer service.

### 3.5.1. SNMP SET with Channel Playback

The Signal Tower and channel playback can be controlled by the SNMP SET command. Below are examples on how to control the Signal Tower, with examples for execution of a "Clear" operation function, and example of simultaneous control of the Signal Tower and channel playback.

[Application Example 1] With the Red Signal Tower set up as follows, it makes the light switch on after 10 seconds.

Object	Object ID	Value
controlLightControlState	1.3.6.1.4.1.20440.4.1.5.1.2.1.2.1	2
controlLightControlTimer	1.3.6.1.4.1.20440.4.1.5.1.2.1.3.1	10

[Application Example 2] With the Yellow Signal Tower set up as follows, it makes the light go out.

Object	Object ID	Value
controlLightControlState	1.3.6.1.4.1.20440.4.1.5.1.2.1.2.2	1
controlLightControlTimer	1.3.6.1.4.1.20440.4.1.5.1.2.1.3.2	0

[Application Example 3] To execute a "Clear" operation function, it is set up as followed.

Object	Object ID	Value
controlLightSnmpClear	1.3.6.1.4.1.20440.4.1.5.1.3.0	1

[Application Example 4] With the Green Signal Tower set up as follows, it plays back channel 65 once, while flashing pattern 2.

Object	Object ID	Value
controlSoundLight	1.3.6.1.4.1.20440.4.1.5.2.2.0	993991001065

### 3.5.2. SNMP GET with Channel Playback

With the SNMP GET command, the Signal Tower status, channel playback, and digital input/output can be acquired. The following is an example of a digital input/output status acquisition.

[Application Example 1] The digital input 3 is "ON", when the GET command is transmitted.

Object	Object ID	GET Value
diEntry3	1.3.6.1.4.1.20440.4.1.4.4.3.0	1

[Application Example 2] The digital output is "OFF", when the GET command is transmitted.

Object	Object ID	GET Value
doEntry1	1.3.6.1.4.1.20440.4.1.4.5.1.0	0

### 3.5.3. TRAP Reception Function

With the set-up containing the designated sender or with the OID included, the TRAP is received. When the TRAP is received, the Signal Tower or channel playback, information regarding the digital output, E-mail Sending, and TRAP transmission can be controlled. The SNMP TRAP is the ability to read SNMP v1 and v2c for receiving, and can register four TRAPs per one setup, and receive 64 kinds of TRAPs with 16 setups to control this product. Refer to "4.13 TRAP Reception Configuration Screen" for details on the setup method.

### Attention

- When the TRAP Reception "GenericTrapttype" is 6 (enterprisespecific), please add the value "0. (specific-trap value)" to the last part of the TRAP Reception to the specific-trap.
- Judgement can be made by the reception function with the number of variable-bindings of 64 with one per trap. To receive more than 64 variable bindings, the traps 1-64 must first be set to operate in the OID at the time of reception. Be aware that the OID after the 65th piece does not operate, even after it is set.
- The model and values judged by a receiver function are; Integers (numerical values) and OCTET STRING (String data): Character strings and Binary OCTET STRING (Binary data).



### 3.5.4. TRAP Transmission Function

The TRAP is sent to the designated sender when the TRAP Reception setup for this product is done. For further details on the setting method, Refer to "4.4 SNMP Configuration Screen". Refer to "5 MIB" regarding TRAP transmission.

Table 3.5.4-1 TRAP Transmission Events

Function Name	Operation Event	Outline
-	At product start-up	At the time of product starting cold start is transmitted.
Command Reception Function	When receiving RSH Commands	When the RSH command is received and executed, it is transmitted. Refer to "3.10 RSH Command Function" for details.
SNMP Function	At an SNMP TRAP reception	Transmits when a TRAP is received. Refer to "4.13 TRAP Reception Configuration Screen" for details.
Digital Input Function	When the digital input status changes	It transmits when the digital input status changes. Refer to "4.12 Digital Input Setup Screen" for details.
Digital Input Condition Function	When the digital input condition agrees	It transmits when the conditions agree. Refer to "4.23 Digital Input Condition Settings Screen" for details.
Ping Monitoring Function	Monitoring object abnormal/restore	It transmits on both monitor abnormality and restoration. Refer to "4.14 Ping Monitoring Configuration Screen" for details.
Application Monitoring Function	Monitoring object abnormal/restore	It transmits on both monitor abnormality and restoration. Refer to "4.15 Application Monitoring Configuration Screen" for details.
SNMP Supported Equipment Monitor Function	Monitoring target when conditions agree/ conditions are restored/ changes are detected	It transmits when conditions agree, conditions are restored, and changes are detected. Refer to "4.21 SNMP Supported Equipment Monitor-Detection Screen 1", or refer to "4.22 SNMP Supported Equipment Monitor-Detection Screen 2"
SLMP Read Command Transmission Function	SLMP Command Condition Agreement SLMP Command Error	It transmits on both condition agreement and error reception. refer to "4.19 SLMP Read Command Configuration Screen" for details.
"Clear" operation function	"Clear" operation run time	Transmits on "Clear" operation run time.
Test Function	Test run time	Transmits on Test operation run time.

## 3.6. SNMP Supported Equipment Monitor Function

For SNMP Supported equipment, with the SNMP command, their status can be acquisitioned periodically and monitored. In correspondence to the setup, status changes can be detected and reported. In the detection, there is a "Condition Agreement Detection" and "Change Detection" method.

### 3.6.1. Condition Agreement Detection

When the SNMP Supported equipment status conditions that are acquired from the condition agreement setup made with the Web setup tool agree, it is the condition agreement detection. When it changes from the condition agreement status into the status conditions that it does not agree with, it will judge whether to cancel the condition status, and run in a monitoring condition.

Refer to "4.21 SNMP Supported Equipment Monitor-Detection Screen 1" for details on the setup method.

#### << Monitoring Operation >>

The SNMP Supported equipment monitoring function will be in a monitoring condition immediately after the setup is completed. The SNMP command is set-up with the monitoring cycle to be transmitted between monitoring conditions.

If the response data from the SNMP Supported equipment is received, it compares data with the status conditions which were set up. When it agrees on the conditions, the judgement status changes to an agreement condition, and the condition agreement operation will execute. During the condition agreement status, the SNMP command transmits and, along with the monitoring condition, compares status conditions. During the condition agreement status, even if the status acquired agrees on conditions, the condition agreement operation does not execute. However, when the status acquired between condition agreements stops agreeing on conditions, it makes a judgement to cancel conditions and goes into a monitoring condition once the condition is canceled.

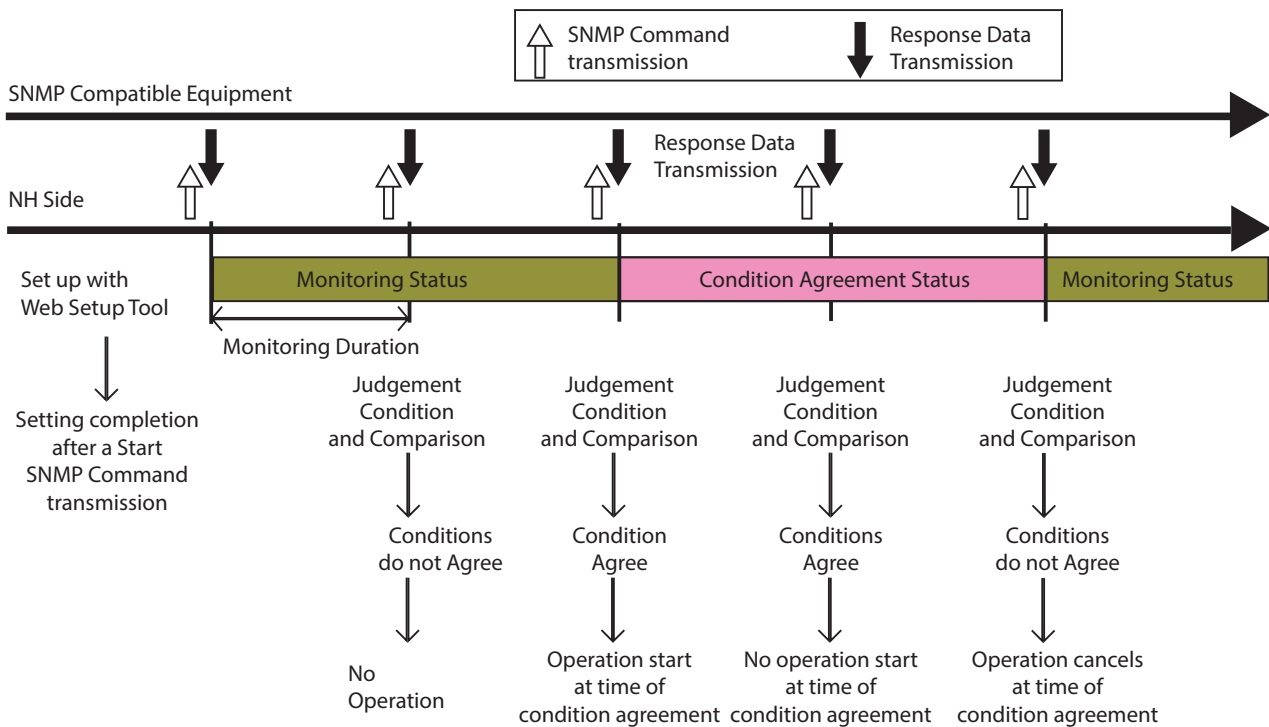

Figure 3.6.1-1 SNMP Supported Equipment Monitor-Condition Agreement Detection

#### MEMO

- In order to return to a monitoring condition from condition agreement status, please push "Set" of the "equipment monitor Setup-Condition Agreement Detection corresponding to SNMP" page of a Web setup tool. The equipment monitor setup status corresponding to all the SNMPs turns into a monitoring condition.

## <<Judgment Conditions>>

Judgment conditions: There are four kinds; "Equal", "equal or greater than", "equal or less than" and "contains".

**"Equal"** : When the set value and the acquired value are the same, it is judged that the condition is met.

**"equal or greater than"**:

When the acquired value is equal or greater than the set value, it is judged that the condition is met.

**"equal or less than"**:

When the acquired value is equal or less than the set value, it is judged that the condition is met.

**"contains"** :

Compares the set value and the acquired value bit by bit. When the set value is included in the acquired value, it is judged that the condition is satisfied.

When monitoring with OCTET STRING (Binary), you can select either "Equal" or "Inclusive".

When monitoring with Integer or OCTET STRING (String), you can only select "Equal".

When monitoring with OCTET STRING (Binary), you can select either "Equal" or "Inclusive".

### [Judgment Example]

#### Value:01 When set to "Equal"

When the acquired value is 01, it is judged that the condition is met because the set value and the acquired value are the same.

If the acquired value is 03, it is judged that the condition is not met because the set value and the acquired value are different.

#### Value:01 When set to "equal or greater than"

When the acquired value is 03, it is judged that the condition is met because the acquired value is greater than the set value.

If the acquired value is 00, it is judged that the condition is not met because the acquired value is less than the set value.

#### Value:01 When set to "equal or less than"

When the acquired value is 00, it is judged that the condition is met because the acquired value is less than the set value.

If the acquired value is 03, it is judged that the condition is not met because the acquired value is greater than the set value.

#### Value: 01 When set to "contains"

If the acquired value is 01, since the set value is included in the acquired value, it is judged that the condition is satisfied.

Acquired value "01" (bit expression 0000 0001)

bit	7	6	5	4	3	2	1	0
	0	0	0	0	0	0	0	1

Set-up value "01" (bit expression 0000 0001)

bit	7	6	5	4	3	2	1	0
	0	0	0	0	0	0	0	1

If the acquired value is 03, since the set value is included in the acquired value, it is judged that the condition is met.

Acquired value "03" (bit expression 0000 0011)

bit	7	6	5	4	3	2	1	0
	0	0	0	0	0	0	1	1

Set-up value "01" (bit expression 0000 0001)

bit	7	6	5	4	3	2	1	0
	0	0	0	0	0	0	0	1

If the acquired value is 04, it is judged that the condition is not met because the set value is not included in the acquired value.

Acquired value "04" (bit expression 0000 0010)

bit	7	6	5	4	3	2	1	0
	0	0	0	0	0	1	0	0

Set-up value "01" (bit expression 0000 0001)

bit	7	6	5	4	3	2	1	0
	0	0	0	0	0	0	0	1

### << "Clear" Operation >>

The operation of when a "Clear" operation from the outside by an SNMP Supported equipment monitoring function is received at the time of a condition agreement is explained. Even if a "Clear" operation in a condition agreement state occurs, the condition agreement status is continued. It is at the next command transmission, when the response data status from the SNMP Supported equipment monitoring function is received, and when the acquired data agrees on conditions, the judgement may be a condition agreement, but the operation may not be activated at the time of the condition agreement.

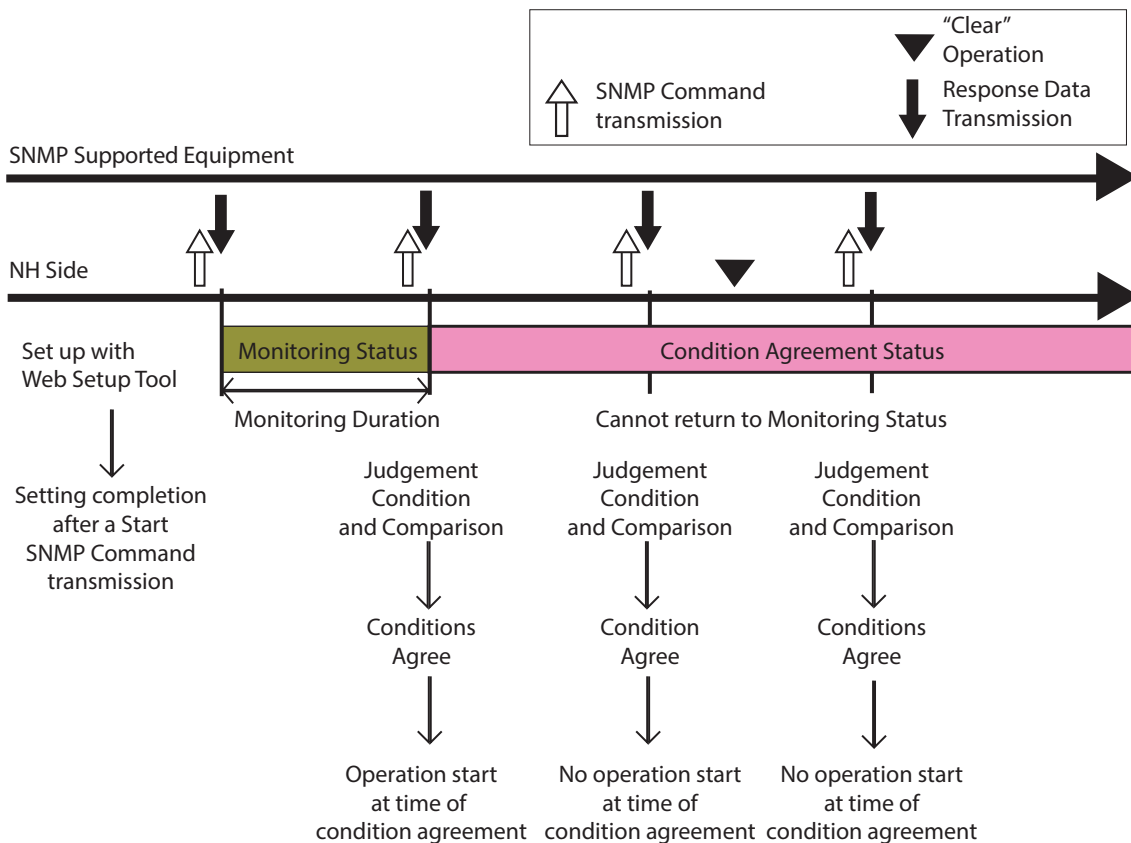

Figure 3.6.1-2 SNMP Supported Equipment Monitor- Clearing Condition Agreement Detection

**MEMO**

- In order to return to a monitoring condition from condition agreement status, please push "Set" of the "SNMP Corresponding Equipment Monitor Setup" page of a Web setup tool. The equipment monitor setup status corresponding to all the SNMPs turns into a monitoring condition.
- Execution of Clear operation will perform control of a Signal Tower and channel playback in accordance with a Clear Setup. The e-mail, TRAP, and SLMP write command transmission is also activated. Refer to "3.15 "Clear" Operation Function" for the details of clear operation.

## << Communication Timeout Operation >>

The following explains when the communication timeout for the SNMP Supported equipment monitoring function operation is set to "Active" when a condition cancellation occurs. When communication becomes impossible between the SNMP Supported equipment and this product during the condition agreement status, it judges from a communication timeout, causing a condition cancellation and returns to a monitoring condition. When a communication timeout and judgement occurs between monitoring conditions, nothing operates. A retry count through an SNMP command can be set up with an arbitrary number from 0 to 10 times can be sent out until it can judge, or a communication timeout occurs.

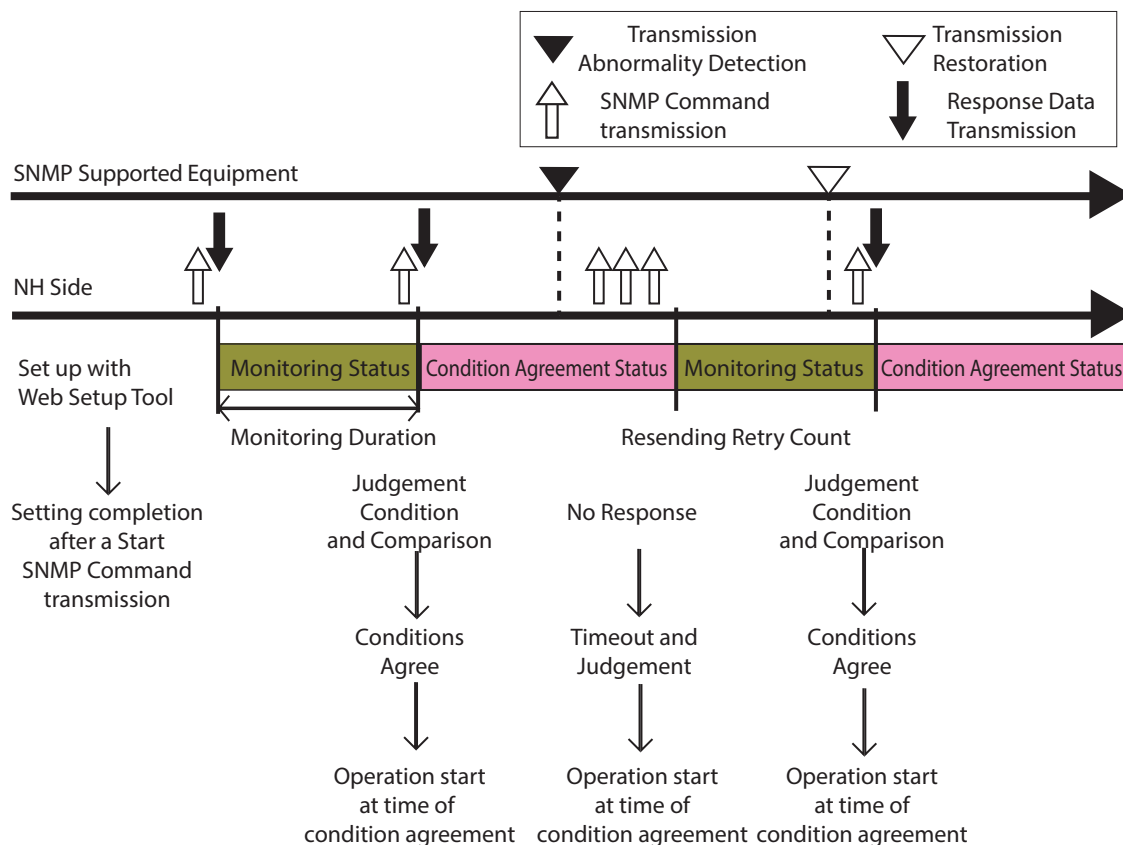

Figure 3.6.1-3 SNMP Supported Equipment Monitor- Communication Timeout Condition Agreement Detection

### MEMO

With it set to Inactive", even if the SNMP Supported Equipment communication becomes impossible, it will not cause an operation cancellation.

## << Re-detection Agreement Status Operation >>

The operation, when selecting the agreement status re-detection operation by the SNMP Supported Equipment Monitor at a condition cancellation is explained. When the agreement status re-detection is selected, the targeted monitoring object can be returned to a monitoring condition, and the detection operation can be restarted. If it returns to a monitoring condition from a re-detection agreement status, the operation does not occur at the time of a condition cancellation. When it agrees on conditions after returning to a monitoring condition, it will operate at a condition agreement.

<< "Monitor Setup 1" re-detection selection is "Equipment 2" (Monitor Setup 2) >>

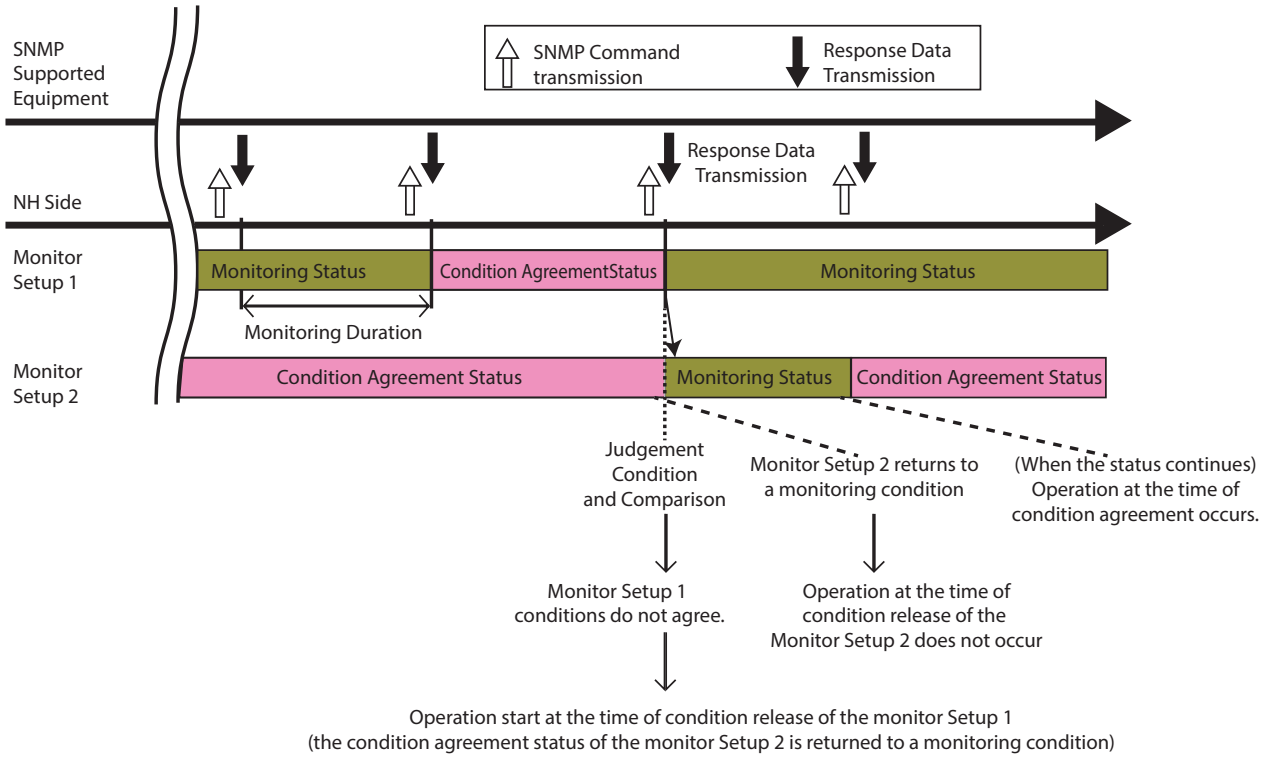

Figure 3.6.1-4 SNMP Supported Equipment Monitor- Clearing Condition Agreement Detection

### 3.6.2. Change Detection

The value of OID designated from the SNMP Supported Equipment is acquired periodically. The acquired value is compared with the previous value acquired, and if the value is changing, it activates the Change Detection. Refer to "4.22 SNMP Supported Equipment Monitor-Detection Screen 2" for details on the setup method.

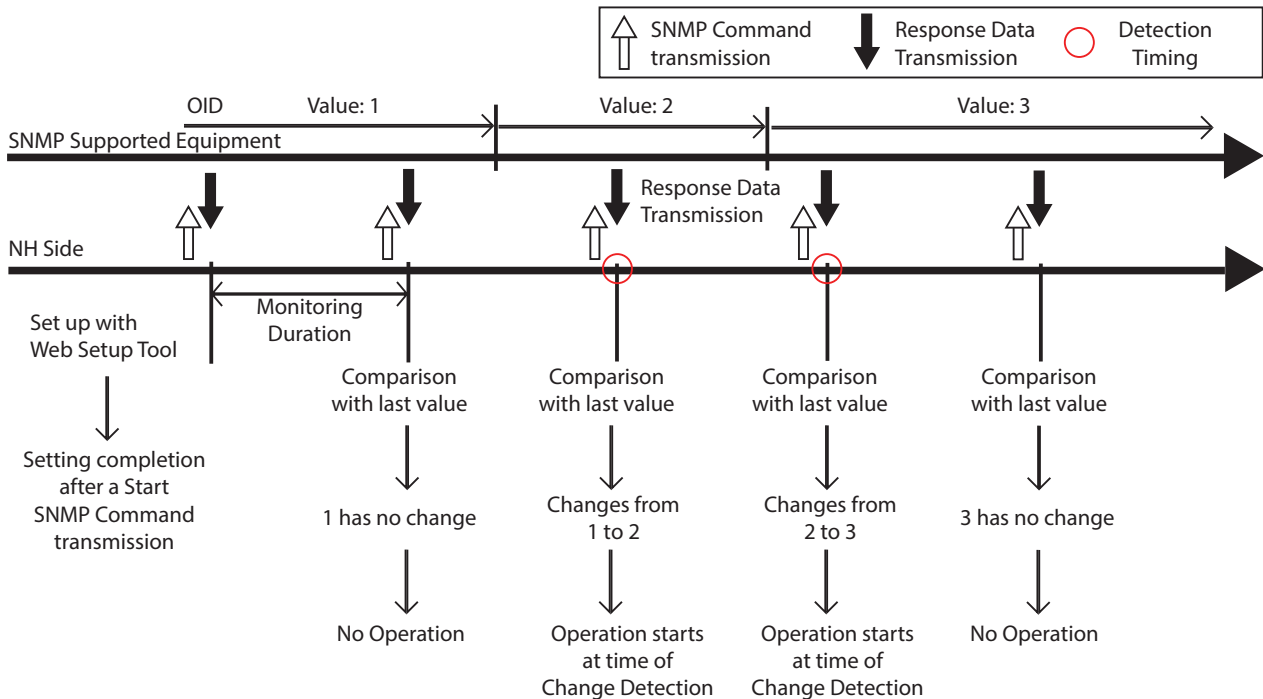

Figure 3.6.2-1 SNMP Supported Equipment Monitor-Condition Agreement Detection

**MEMO**

- When a communication Error occurs, the returned communication value is not acquisitioned immediately after a detection in change. The acquisitioned value also does not operate immediately after a setting has been made in the Web setup tool.
- An acquired value is labeled as an "Integer."

## 3.7. PHN Command Reception Function

With this product, the PHN series Socket Communication control protocol is used, and controls channels 61 and 62 (buzzer pattern 1, 2) of the Signal Tower. The Socket Communication protocol can select a select from "TCP" - "UDP", and the port number can select "10000-65535." The following explains the PHN commands used by the socket communication function. Refer to "4.5 Socket Transmission Configuration Screen" for details on the setup method.

### Writing Command

The following data form is transmitted and controls the red, yellow, green, and channels 61 and 62 (buzzer patterns 1 and 2) of the Signal Tower.

W (57H) 8 Bit								Operation Data 8 Bit			
0	1	0	1	0	1	1	1	Refer to Operation Data			

### Operation Data

Data Area 8 Bit							
Signal Tower Flashing Pattern 1			Channel (Buzzer Pattern)		Signal Tower Flashing		
Green	Amber	Red	Channel 62 (Buzzer Pattern 2)	Channel 61 (Buzzer Pattern 1)	Green	Amber	Red

### [Example of sending the writing command transmission]

When the red and yellow LED lights are on and channel 62 (Buzzer Pattern 2) is sounding Operation Data is entered as a "1" to operate, and a "0" is entered when it does not operate.

#### [Command]

W (57H)								Operation Data (13H)							
0	1	0	1	0	1	1	1	0	0	0	1	0	0	1	1

#### Response from this product

- Normal response (output response)

A (41H)	C (43H)	K (4BH)
1 byte	1 byte	1 byte

- Response Error (output failed)

N (4EH)	A (41H)	K (4BH)
1 byte	1 byte	1 byte

#### Attention

- The following are Signal Tower lighting and channels that are not controllable by the PHN Command for This product. When controlling, use other methods available, such as PNS Commands and RSH Commands.
  - Signal Tower red, yellow and green flashing pattern 2.
  - Signal Tower blue and white lighting, flashing pattern 1 and flashing pattern 2.
  - Channels 1-60, Channels 63-70.
- Channels 61 and 62 (buzzer pattern 1, 2) are always played back by the Input Priority Playback Mode. Refer to "3.1.7 Playback mode" for details.

## Reading Command

The current operating status of this product is requested.

R (52H) 8 bit							
0	1	0	1	0	0	1	0

Response from this product:

R (52H) 8 bit								Signal Tower Flashing Pattern 1			Channel (Buzzer Pattern)		Signal Tower Lighting		
0	1	0	1	0	0	1	0	Green	Amber	Red	Channel 62 (Buzzer Pattern 2)	Channel 61 (Buzzer Pattern 1)	Green	Amber	Red

### [Example for a data acquisition response]

When the Signal Tower green is lighting and yellow is flashing pattern 1:

Reply Data :0100 0100 = 44H

R (52H) 8 bit								Reply Data (44H) 8 bit							
0	1	0	1	0	0	1	0	0	1	0	0	0	1	0	0

Signal Tower red flashes pattern 1 and channel 62 (Buzzer Pattern 2) sounds:

Reply Data :0011 0000= 30H

R (52H) 8 bit								Reply Data (30H) 8 bit							
0	1	0	1	0	0	1	0	0	0	1	1	0	0	0	0

#### Attention

- The following are Signal Tower lighting and channels that are not controllable by the PHN Command for This product. When controlling, use other methods available, such as PNS Commands and RSH Commands.
  - Signal Tower red, yellow and green flashing pattern 2.
  - Signal Tower blue and white lighting, flashing pattern 1 and flashing pattern 2.
  - Channels 1-60, Channels 63-70.



## 3.8. PNS Command Reception Function

A PNS Command is an exclusive command which controls PATLITE networking products. The Socket Communication protocol can be selected from "TCP" or "UDP", and the communication port is from "10000-65535." The following explains the PNS commands being used with a socket communication setup.

Figure 3.8.2-1 Identifier List

Identifier	Summary
S (53H)	Playback of a Signal Tower and a buzzer pattern is controlled.
V (56H)	A specified channel is reproduced and stopped.
D (44H)	A digital output is controlled.
W (57H)	A Signal Tower and channel playback are controlled simultaneously.
G (47H)	The playback status of a Signal Tower and a buzzer pattern is acquired.
C (43H)	An operating state is changed into the status at the time of normal operation.

### Writing Command

Sending data in the following form will transmit data to control the Signal Tower and buzzer pattern to play back.

Product Classification "XX"	Identifier [S]	(Empty)	Data Size	Data Area 6 byte					
58H	58H	53H	00H	00H	06H	Refer to below			

#### Product Classification

Product classification of this product is fixed at "XX".

#### Identifier

"S" is used.

#### Data Size

The data area capacity is written.

#### Data Area

Data Area 6 byte					
Signal Tower					Preset Channel
1	2	3	4	5	6
Red	Amber	Green	Blue	White	Buzzer Pattern 1 - 4
Signal Tower			Preset Channel		
Lights Out	00H		Stop	00H	
Lighting	01H		Buzzer Pattern 1	01H	
Flashing Pattern 1	02H		Buzzer Pattern 2	02H	
Flashing Pattern 2	03H		Buzzer Pattern 3	03H	
No Change	09H		Buzzer Pattern 4	04H	
			No Change	09H	

### [Example of sending the writing command transmission]

With the Signal Tower red tier lighting, green off, and all others maintaining their status, Channel 61 (Buzzer Pattern 1) is played back.

#### [Command]

Product Classification "XX"	Identifier [S]	(Empty)	Data Size	Data Area 6 byte							
58H	58H	53H	00H	00H	06H	01H	09H	00H	09H	09H	01H

#### Attention

Channels 61 - 64 (Buzzer Pattern 1-4) is normally played in the Input Priority Mode. Refer to "3.1.7 Playback Mode" for details.

**Response from this product:**

- Normal response (Output Response)

ACK
06H

- Response Error (Output Failed)

NAK
15H

<< MP3 Channel Control Commands >>

If the following data is transmitted, it can playback and stop the designated channels.

Product Classification "XX"		Identifier [V]	(Empty)	Data Size		Data Area 4 byte
58H	58H	56H	00H	00H	04H	Refer to below

**Product Classification**

Product classification of this product is fixed at "XX".

**Identifier**

"V" is used.

**Data Size**

The data area capacity is written.

**Data Area**

Data Area 4 byte			
1	2	3	4
Playback Pattern	Repeat Playback	(Empty)	Channel Number

**Data List**

**Playback Pattern**

Playback Stop (Sending Music)	00H
Repeat Playback	01H

**Message Repeat Capability**

Repeat (0 - 255)	00 - FFH
When designated as 0 times and it is a one-shot playback. When it is designated as repeat playback, where up to 255 is endless playback.	

**Channel Number**

Channel (1 - 70)	01 - 70H Entered as BCD (Binary Coded Decimal)
------------------	---

**[Example for a data acquisition response]**

When the operation requires channel 32 to be played 15 times:

**[Command]**

Product Classification "XX"		Identifier [V]	(Empty)	Data Size		Data Area			
58H	58H	56H	00H	00H	04H	01H	0EH	00H	32H

**Attention**

Channels 61-64 (Buzzer Pattern 1-4) is normally played in the Input Priority Mode. Refer to "3.1.7 Playback Mode" for details.

**Response from this product:**

- Normal response (Output Response)

ACK
06H

- Response Error (Output Failed)

NAK
15H

<< Digital Output Control Commands >>

The digital output will be turned on and off when the following data is transmitted.

Product Classification "XX"		Identifier [D]	(Empty)	Data Size		Data Area 1 byte
58H	58H	44H	00H	00H	01H	Refer to below

**Product Classification**

Product classification of this product is fixed at "XX".

**Identifier**

"D" is used.

**Data Size**

The data area capacity is written.

Data Area
Data Area 1 byte
1
Digital Output

**Data List**

Digital Output	OFF	00H
Digital Output	ON	01H
Digital Output	No Change	09H

**[Digital Output Control Command Transmission Example]**

When the Digital Output is turned "ON."

**[Command]**

Product Classification "XX"		Identifier [D]	(Empty)	Data Size		Data Area
58H	58H	44H	00H	00H	01H	01H

**Attention**

The digital output control command is only effective when the relay contact output is set in the "digital output mode". Refer to "3.2.5 Relay Contact Output Control Function" for details.

## << Signal Tower/ Channel Control Commands >>

If the following is transmitted, it can control both the Signal Tower and channel playback.

Product Classification "XX"		Identifier [W]	(Empty)	Data Size			Data Area 10 byte			
58H	58H	57H	00H	00H	0AH	Refer to below				

### Product Classification

Product classification of this product is fixed at "XX".

### Identifier

"W" is used.

### Data Size

The data area capacity is written.

### Data Area

Data Area 10 byte									
Signal Tower					Channel				
1	2	3	4	5	6	7	8	9	10
Red	Amber	Green	Blue	White	(Empty)	Playback Pattern	Repeat Playback	(Empty)	Channel Number

### Data List

#### [Signal Tower]

Lights "OFF"	00H
Lights "ON"	01H
Flashing Pattern 1	02H
Flashing Pattern 2	03H
No Change	09H

#### [Channel]

Playback Pattern	
Playback Stop (Sending Music)	00H
Repeat Playback	01H

#### Repeat Playback

Number (0 - 255 times)	00 - FFH
When designated as 0 times and it is a one-shot playback.	
When it is designated as repeat playback, where up to 255 is endless playback.	

#### Channel Number

Channel (1 - 70)	01 - 70H
Entered as BCD (Binary Coded Decimal)	

### **[Example of sending the Signal Tower/ Channel Control Command transmission]**

With the Signal Tower red tier lighting, amber off, all others maintain their status and channel 65 is played back three times.

#### [Command]

Product Classification "XX"		Identifier [W]	(Empty)	Data Size			Data Area								
58H	58H	57H	00H	00H	0AH	01H	00H	09H	09H	09H	00H	01H	02H	00H	65H

#### Response from this product:

- Normal response (Output Response)

ACK
06H

- Response Error (Output Failed)

NAK
15H

## Reading Command

Transmitting the following data will execute the status of the Signal Tower and buzzer pattern.

Product Classification "XX"		Identifier [G]	(Empty)	Data Size	
58H	58H	47H	00H	00H	00H

### Product Classification

Product classification of this product is fixed at "XX".

### Identifier

"G" is used.

### Data Size

The data area capacity is written.

Data Area 6 byte					
Signal Tower					Preset Channel
1	2	3	4	5	6
Red	Amber	Green	Blue	White	Buzzer Pattern

## [Example for a data acquisition response]

When the Signal Tower red and white are lighting; amber is flashing pattern 1; green and blue are "OFF", and channel 63 (Buzzer Pattern 3) is in playback.

Data Area 6 byte					
Signal Tower					Preset Channel
1	2	3	4	5	6
01H	02H	00H	00H	01H	03H

## << Status Condition "Clear" Command >>

The Signal Tower returns to its normal status, channel playback is stopped and the monitoring abnormality status returns to its normal monitoring condition. The time that was currently measured from the input condition Setup is reset. Refer to "3.15 "Clear" Operation Function" for command operation run-time.

Product Classification "XX"		Identifier [C]	(Empty)	Data Size	
58H	58H	43H	00H	00H	00H

### Product Classification

Product classification of this product is fixed at "XX".

### Identifier

"C" is used.

## 3.9. Mail Transmission Function

Up to eight E-mail subjects can be registered to transmit. The subject and message of the transmitting mail can be registered for 16 different situations per title to be transmitted via e-mail to the 8 registered addresses. The user authentication method during transmission can be selected from either "SMTP Authentication", "POP Authentication", or "No Authentication". Refer to "4.6 E-Mail Settings Screen" and to "4.7 E-Mail Message Settings Screen" on pg. 112 for more details.

### 3.9.1. E-mail Message Contents

Up to 16 subjects with mail containing text for transmission can be selected to be registered, with one subject set as a fixed subject. The e-mail text would include the equipment name, its location, the sender, the message, and supplementary information indicated in Refer to "Table 3.9.1-1" below. The contents of the registered subject is indicated. If the 17th fixed e-mail subject title "NH-ORIGINAL" is selected, the equipment location, message transmission time stamp, and event contents is indicated. If the 17th e-mail subject text is selected as "None", nothing is indicated in the text. E-mail is transmitted with the following contents.

[Registered subject title when selecting No. 17 as "NH-ORIGINAL"]

#### **System Format: YY/MM/DD hh:mm Event Contents: Name**

Table 3.9.1-1 Fixed Written Subject Contents

Generated Event	Indicated Event Contents	Indicated Name
TRAP Reception	Blank	TRAP Monitor Setup Registered Group Name
Execute "Clear" by pushbutton switch	": CLEAR-Switch"	Blank
Execute SNMP "Clear"	": CLEAR-Snmp"	Blank
Execute RSH "Clear"	": CLEAR-Rsh"	Blank
Ping Monitor Abnormality Detection	": PING-Error"	The equipment name registered in the Ping Monitor setup
Ping Monitor Recovery Detection	": PING-Recover"	The equipment name registered in the Ping Monitor setup
Application Monitor Abnormality Detection	": APP-Error"	The equipment name registered in the Application Monitor setup
Application Monitor Recovery Detection	": APP-Recover"	The equipment name registered in the Application Monitor setup
Execute an "RSH Command"	": RSH-Executes"	Blank
Press the "TEST" button	": TEST-Switch"	Blank
SLMP Operation	": SLMP-Action"	The device registration number corresponding to conditions 1-16
SLMP Error Reply	": SLMP-Error"	Blank
Digital input contact ON status change	": DINPUT-On"	Digital input numbers from DI1-DI4 are turned on
Digital input contact OFF status change	": DINPUT-Off"	Digital input number 1 is turned off
SNMP supported equipment monitor agreement	": SNMPGET-Match"	SNMP supported equipment monitor Setup - Device names registered for the Condition Agreement
SNMP supported equipment monitor cancellation	": SNMPGET-Release"	SNMP supported equipment monitor Setup - Device names registered for the Condition Agreement
SNMP supported equipment monitor change detection	": SNMPGET-Change"	SNMP supported equipment monitor Setup - Device names registered for the Change Detection
When the digital input condition agrees	": DINPUT-Condition"	digital input numbers 1-4 setup with agreeing conditions

Table 3.9.1-2 Transmission Mail Contents

System Location	: <The setup location is registered>
System Name	: <The device name setup is registered>
Contact Address	: <The contact address setup is registered>
Generated Event	: <The E-mail sending opportunity event to be used is registered>
Supplementary Information	: <Indicates accompanied information for a registered event>
	<The selected text is registered>

Table 3.9.1–3 E-mail Sending opportunity

Classification	Contents
TRAP Reception	Transmits when a registered TRAP is received.
"Clear" by pushbutton switch	It transmits when the clear switch to this product is pushed.
"Clear SNMP" Execution	When an SNMP "SET" is operating and a "controlLightSnmpClear" command is transmitted, a "Clear" is executed.
"Clear RSH" Execution	A "Clear" command is received and is transmitted to be executed.
Ping monitoring object status change	When a Ping monitored object is in an abnormal condition, or is restored from an abnormal condition, a transmission is executed.
application monitoring object status change	When an Application monitored object is in an abnormal condition, or is restored from an abnormal condition, a transmission is executed.
"RSH Command" Execution	When the RSH command is received, a transmission is sent when the command is executed.
Press the "TEST" button	When the test switch is pushed, a transmission is sent.
During an SLMP Condition Agreement	When the SLMP monitoring equipment status agrees on setting conditions, a transmission is sent.
During an SLMP Error Reply	When error information is acquired from the SLMP monitoring equipment, a transmission is sent.
Digital Input Status Change	When the status changes in a digital input, a transmission is sent.
SNMP supported equipment monitoring status change	When an SNMP supported equipment status condition agrees, or when a detection in change occurs, a transmission is sent.
During a digital input condition setup agreement	When conditions agree on the set up by the digital input condition, a transmission is sent.

Table 3.9.1–4 Written E-mail Event and Supplementary Information

Written Event	Written Supplementary Information
TRAP was received	Group Name : Registration Address
The "Clear" Switch was pushed	None
A "Clear" was made by the SNMP	None
A "Clear" was made by the RSH	IP Address
Ping Monitor Abnormality detected.	Equipment Name : Registration Address
Ping Monitor Recovery detected.	Equipment Name : Registration Address
Application Monitor Abnormality detected.	Equipment Name : Registration Address : Port Number
Application Monitor Recovery detected.	Equipment Name : Registration Address : Port Number
RSH Command was executed	IP Address
Test Switch was pressed	None
SLMP operation was executed.	Device Name : Registration Address
An SLMP error occurred.	Device Name : Registration Address
Digital Input was set to ON.	Port Number [1-4]
Digital Input was set to OFF.	Port Number [1-4]
Conditions agreed with the SNMP supported equipment.	Setup Name : Registration Address
Conditions agreed with the SNMP supported equipment were cancelled.	Setup Name : Registration Address
SNMP supported equipment changes were detected.	Setup Name : Registration Address
Digital Input conditions agree.	Input Conditions [1-4]

## 3.10. RSH Command Function

RSH (remote shell) is a CUI program which executes a shell command from one computer to another computer via a computer network. The following explains how to control the Signal Tower via the RSH command.

### 3.10.1. RSH Command Reception

The command syntax which this product can receive is indicated below. For the setting method of the "RSH Command Connection Authentication /Operation after Reception", refer to "4.8 RSH Command Configuration Screen" on pg. 113

Table 3.10.1-1 Receivable Commands

Command	Contents
alert	Can control the Signal Tower/Buzzer
alert do	Can control the Digital Output.
sound	Can simultaneously control the Signal Tower and channel playback.
clear/doclear	Returns to Normal Mode
status	Acquisitions the Signal Tower Status
test/dotest	Executes a Self-test

<< Using the RSH Commands >>

Command Input Method

rsh\_IPAddress\_-l\_account\_Command\_[Option]

Command Input Method (when the designated sender address is inactive)

rsh\_IP address\_-l\_Common account when designated sender address is inactive\_Command\_[Option]

#### MEMO

- \_ : indicates a space. [ ] : indicates an option. The use of login abbreviations for the login name is limited to when the account name and the PC are registered on the command reception screen which transmits the RSH command.
- Here, "ON" and "OFF" expresses the digital logic value for each port. The contact switching conditions vary between the "A-contact" and "B-contact."

### alert Command

Contents : To control the Signal Tower and buzzer.  
 Syntax : alert\_rygbcz\_[sec]  
 Return Value : Status after command is executed.  
 Option : Refer to "Table 3.10.1-2"

Table 3.10.1-2 RSH Command Option Explanation

Type	Explanation
rygbc	r: Red, y: Amber, g: Green, b: Blue, c: White (0) Light Off, (1) Lighting, (2) Flashing Pattern 1, (3) Flashing Pattern 2, (9) No Change
bz	bz: Channels 61-64 (Buzzer Patterns 1-4) (0) Mute, (1) Channel 61 (Buzzer Pattern 1), (2) Channel 62 (Buzzer Pattern 2), (3) Channel 63 (Buzzer Pattern 3), (4) Channel 64 (Buzzer Pattern 4), (9) No Change
sec	Restores the Signal Tower to its previous command status. When it exceeds the setup time (Timer restoration function), it returns to the operation of the Signal Tower and channels 61-64 (Buzzer Pattern 1-4) before restoring the timer restoration function. The time can be set from zero to 99. The status will not return if no input or a zero has been entered.

[Command Transmission Example]

**Ex.)** A product with an IP address of [192.168.10.10] and account is "root",  
 with the Red and Green Lighting, all others turned off and Channel 62 (Buzzer Pattern2) in playback:

rsh\_192.168.10.10\_-l\_root\_alert\_101002

Reply: 101002

#### Attention

Channels 61 - 64 (Buzzer Pattern 1-4) is normally played in the Input Priority Mode. Refer to "3.1.7 Playback Mode" for details.



## alert do Command

Contents : To control the Digital Output.  
 Syntax : alert\_do\_[relay status]  
 Return Value : Status after command is executed  
 Option : Refer to "Table 3.10.1-3"

Table 3.10.1-3 RSH Digital Output Command Option Explanation

Type	Explanation
Relay Status	Relay Output Function Digital Output Conditions: (0) OFF, (1) ON, (9) No Change

[Command Transmission Example]

**Ex.)** A product with an IP address of [192.168.10.10] and account is "root", with the Digital Output turned ON:

```
rsh_192.168.10.10_-l_root_alert_do_1
```

```
Reply: 1
```

### Attention

With the BUSY output setting, the digital output operation for the RSH command cannot be executed during a BUSY output operation.

## sound Command

Contents : To control the Signal Tower and Channel playback simultaneously.  
 Syntax : sound\_[-r Repeat Playback]\_[-c rygbc]\_ch  
 Return Value : After command, channel playback is executed  
 Option : Refer to "Table 3.10.1-4"

Table 3.10.1-4 RSH sound Command Option Explanation

Type	Explanation
None	One shot playback is executed.
-r Repeat Playback	A setup for the number of times the "Message Repeat" function plays back for the selected channel. The setup range is "0-255." "0" becomes the same operation as a "one shot playback". "255" becomes the same operation as an "endless playback".
-c rygbc	r: Red, y: Amber, g: Green, b: Blue, c: White (0) Light Off, (1) Lighting, (2) Flashing Pattern 1, (3) Flashing Pattern 2, (9) No Change
ch	A set up for a designated channel (1 - 70).

[Command Transmission Example]

**Ex. 1)** A product with an IP address of [192.168.10.10] and an account of "root", with Channel 24 set as a one shot playback:

```
rsh_192.168.10.10_-l_root_sound_24
```

with all the Signal Tower Lights turned off (no login name):

```
rsh 192.168.10.10 clear -p
```

**Ex. 2)** A product with an IP address of [192.168.10.10] and a designated sender user name of "patlite", with Channel 39 set to repeat playback 7 times:

```
rsh_192.168.10.10_-l_patlite_sound_-r_6_39
```

**Ex. 3)** A product with an IP address of [192.168.10.10] and the account omitted, with the red Signal Tower light ON, amber OFF, all others no change in condition and Channel 68 set to playback in an endless mode:

```
rsh_192.168.10.10_sound_-r_255_-c_10999_68
```

### Attention

Channels 61 - 64 (Buzzer Pattern 1-4) is normally played in the Input Priority Mode. Refer to "3.1.7 Playback Mode" for details.

### stop Command

Contents : To stop a Channel while in playback.  
 The channel is reproduced in cases where there is a channel registered into the channel memory in the time of memory playback mode.

Syntax : stop

Return Value : When the channel number which was being reproduced before the stop has been stopped, it is "0."

[Command Transmission Example]

**Ex. 1)** A product with an IP address of [192.168.10.10] and an account of "patlite", with Channel 55 set for playback and no channel memory registered:

rsh\_192.168.10.10\_-l\_patlite\_stop

Reply: 55

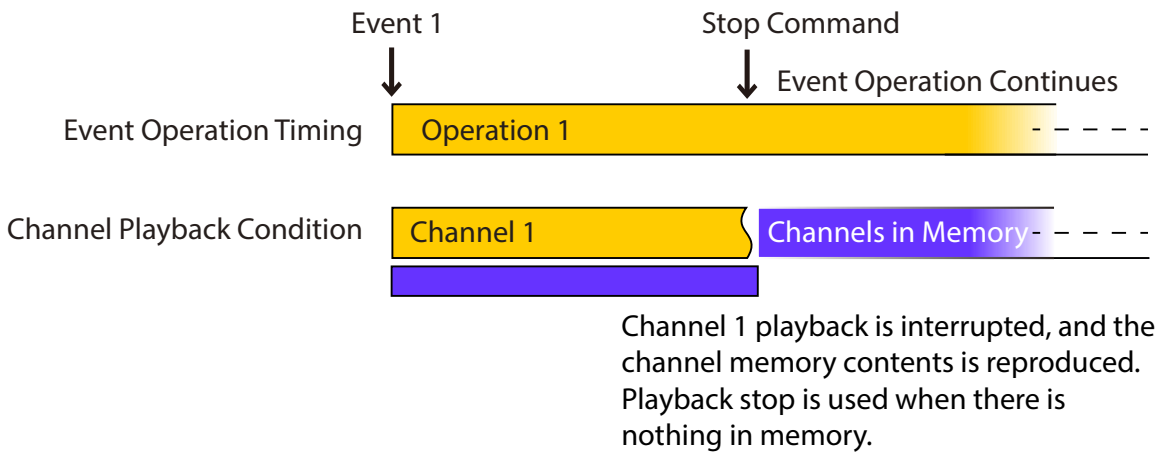

### clear / do clear Command

Contents : All Signal Tower lights are off and the channel played back is stopped.  
 Also, the monitoring condition status changes to monitor abnormality status. All the time that was currently measured by the input condition Setup is reset.  
 Refer to "3.15 "Clear" Operation Function" for command operation run-time.

Syntax : clear, doclear

Return Value : Status after command is executed.

[Command Transmission Example]

**Ex. 1)** A product with an IP address of [192.168.10.10] and a designated account "patlite":

rsh\_192.168.10.10\_-l\_patlite\_clear

A shortcut code can be made for the account:

rsh\_192.168.10.10\_clear

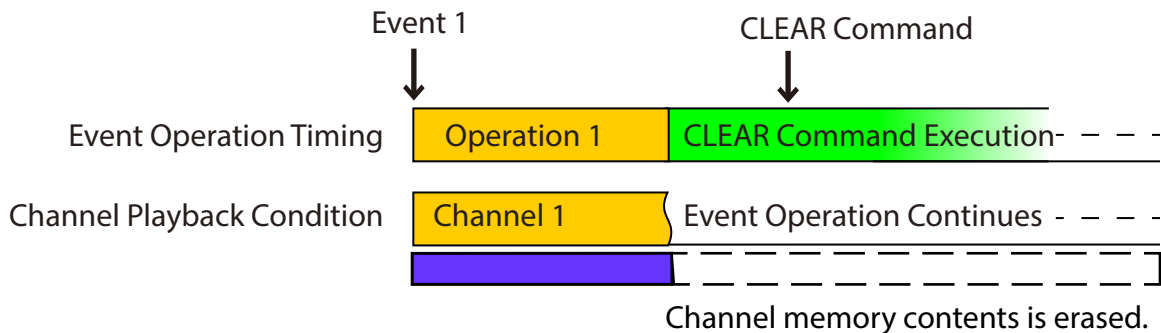

## **status Command**

Contents	:	The Signal Tower, channel playback and digital input/output status is returned.
Syntax	:	status_[-s]_[di]_[do]
Return Value	:	The current condition.
Option	:	Refer to "Table 3.10.1-5 Command Option Explanation"

Table 3.10.1-5 Command Option Explanation

Type	Explanation
di	The digital input status is returned.
do	The digital output status is returned.
-s	The played back channel number is returned.

### [Command Transmission Example]

With the IP address "192.168.10.10" and a "patlite" account, a condition of: red flashing pattern 1, green lighting, channel 63 (Buzzer Pattern 3), digital inputs 1 and 4 are in an OFF operating state and 2 and 3 are in an ON state; the relay-contact output in an ON state of the Main Unit has been acquisitioned:

**Ex. 1)** For the "status", the Signal Tower status is returned.

```
rsh_192.168.10.10_-l_patlite_status
```

```
Reply: 201003
```

**Ex. 2)** When adding the option "di", the status of the digital input Terminal Buss will be returned.

```
rsh_192.168.10.10_-l_patlite_status_di
```

```
Reply: DI: 0110
```

**Ex. 3)** When adding the option "do", the status of the digital output terminal will be returned.

```
rsh_192.168.10.10_-l_patlite_status_do
```

```
Reply: DO: 1
```

**Ex. 4)** When adding the option "-s", the channel number during playback will be returned.

```
rsh_192.168.10.10_-l_patlite_status_-s
```

```
Reply: 63
```

With the IP address "192.168.10.10" and a "patlite" account, a condition of: amber flashing pattern 2, blue lighting, no channel playback, digital inputs 1 and 2 are in an OFF operating state and 3 and 4 are in an ON state; the relay-contact output in an OFF state of the Main Unit has been acquisitioned.

**Ex. 5)** When adding the option "-s", there is no channel in playback.

```
rsh_192.168.10.10_-l_patlite_status_-s
```

```
Reply: 0
```

**Ex. 6)** Addition of an option "di" and "do" will return the status of a digital input Terminal Buss and a digital output terminal stand, respectively.

```
rsh_192.168.10.10_-l_patlite_status_di_do
```

```
Reply: DI: 0011
```

```
DO: 0
```

## **test / do test Command**

Contents : Signal Tower and voice playback function confirmation operation is executed.  
When all the Signal Tower lights are switched off and channels 61 - 64 (Buzzer Patterns 1-4) are in playback, after stopping playback, the Signal Tower red changes to white within a 1 second gap and channel 61 (Buzzer Pattern 1) continues to play back.

Syntax : test, dotest  
Return Value : None

[Command Transmission Example]

**Ex. 1)** When the product's IP address "192.168.10.100" operation has been confirmed.

When using invalid designated sender address account "patlite":

```
rsh_192.168.10.10_-l_patlite_test  
rsh_192.168.10.10_-l_patlite_dotest  
Reply: None  
A shortcut code can be made for the account:  
rsh_192.168.10.10_test  
rsh_192.168.10.10_dotest  
Reply: None
```

**Ex. 2)** When the product's IP address "192.168.10.100" operation has been confirmed.

When the account "root" is used.

```
rsh_192.168.10.10_-l_root_test  
rsh_192.168.10.10_-l_root_dotest  
Reply: None  
A shortcut code can be made for the account:  
rsh_192.168.10.10_test  
rsh_192.168.10.10_dotest  
Reply: None
```

### **Attention**

- Executing a test will operate the Signal Tower, so when testing it while in use, be sure to check that it is enough for satisfactory conditions.
- Even during the execution of a test, the monitoring function is still operating, so be sure to check this product while the monitoring function is in operation.
- Executing a test can be done during and after the return of an "Abnormal Acknowledge" in a PHN Command and PNS Command. A "BUSY Acknowledge" is also returned by the RSH command.
- After the test execution is completed, the monitoring function can usually resume operation through the Signal Tower.
- When performing a stop, refer to "3.15 "Clear" Operation Function" for details on how to execute the stop method during the test operation.
- Executing the test operation will clear any channel memory.

### **3.10.2. RSH alert Timer Reset Function**

The timer function operation can set up the operating time for each color and buzzer pattern of the Signal Tower, and can be selected between "Shared" or "Individual".

- Shared: Each Signal Tower tier and buzzer are controlled by a common timer.
- Individual: Each Signal Tower tier and buzzer are controlled by individual timers.

The following explains the difference in operation between the "Shared" and "Individual" selection for this product when setting up the alert timer reset function.

[Process]

(1) Transmit the command to the products IP address "192.168.10.10."

Account executes the command for "root," which operates "red is lighting" for 10 seconds.

```
rsh_192.168.10.10_-l_root_alert_199999_10
```

(2) 3 seconds after (1), the command is transmitted to the products IP address "192.168.10.10."

Account executes the command for "root," which operates "white is lighting" for 10 seconds.

rsh\_192.168.10.10\_-l\_root\_alert\_999919\_10

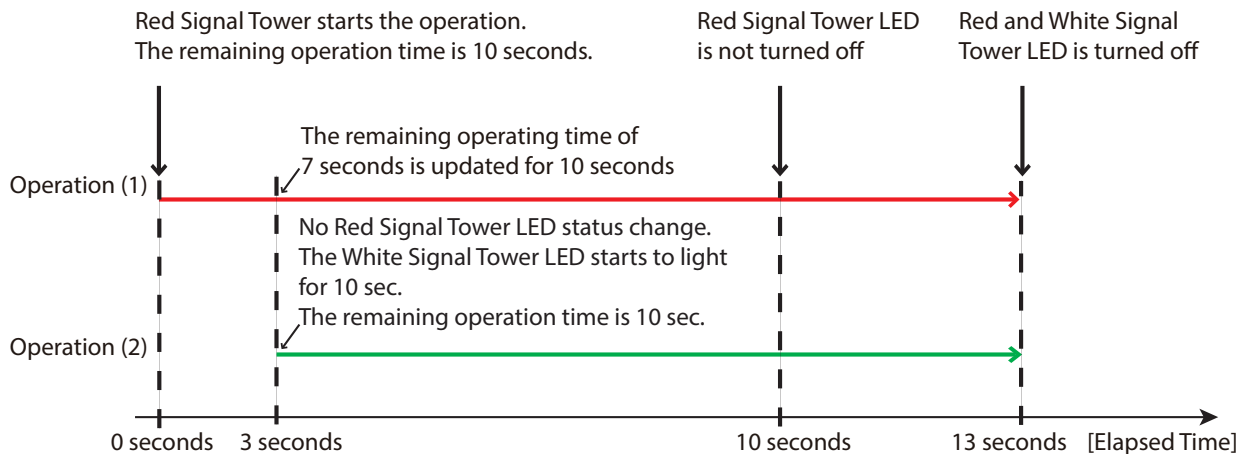

Figure 3.10.2-2 "Shared" Timer restoration functional operation

### << Alert Timer Reset Function set for "Shared" >>

The alert command made into "9" for the Signal Tower and buzzer channel (No operation) are affected by the influence of the duration after the command timer was executed.

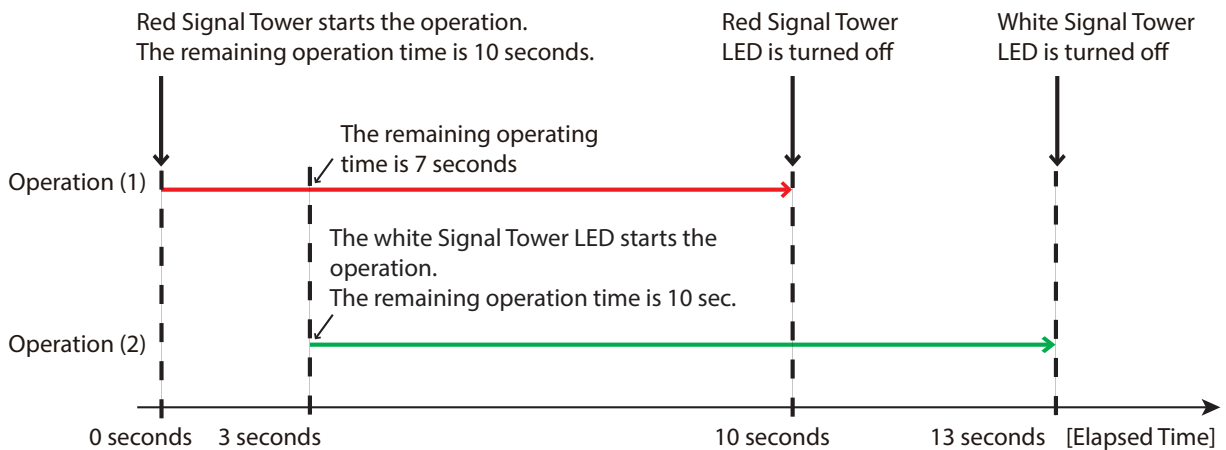

Figure 3.10.2-3 "Individual" Timer restoration functional operation

### << Alert Timer Reset Function set for "Individual" >>

The alert command made into "9" for the Signal Tower and buzzer pattern (No operation) are not affected by the influence of the duration after the command timer was executed.

#### Attention

- For the hold input priority mode, timer restoration is canceled if another channel is reproduced during the Execution of timer restoration.
- In the memory playback mode, during timer restoration, channels outside channels 61 - 64 (Buzzer Patterns 1-4) being played back become registered in the channel memory. While channels 61-64 (Buzzer Patterns 1-4) are played, they are immediately played back when the timer restoration is canceled.
- If channels other than channel 61 - 64 (Buzzer Patterns 1-4) are being reproduced before timer restoration is executed, a channel may not play back, even if the timer's setup-time has elapsed.

## 3.11. Ping Monitoring Function

The Ping Monitoring Function is used to monitor the response of a device in a network, by sending pings for up to 24 devices. Each device may be set to have a unique ping cycle and, if there is a failure in response, a unique light and buzzer status to indicate when there is a failure to respond. With a maximum of 24 devices that can be monitored, each device can be set up to be monitored by Ping requests.

### 3.11.1. Ping Monitoring Function

The following explains how to set up the Cycle count Error threshold and Pings per test cycle for the Ping Monitoring Function. A Ping test cycle period can be set up for 1 to 600 seconds, and the Pings per test cycle can be set up 1-3 pieces and a Cycle count Error threshold from 0 to 30 times. The following is an example of setting the Pings per test cycle with a value of "2" and "3." If a Cycle count Error threshold is set to "2", in cases where abnormality detection was generated twice, the Ping monitor abnormality function will operate. If the Pings per test cycle is set to "3", then the Pings per test cycle will send three "packets" during the Ping test cycle period. (Refer to "Figure 3.11.1-1" for reference)

An abnormality judgement is detected during a Ping test cycle period.

- ① . If one Ping response out of three "packets" is received, then judgement of no abnormality is detected.
- ② . If all three Ping responses were not answered among the three "packets", it counts as one time for judging that an abnormality is occurring.
- ③ . Even in the following time period, if there is no Ping response, the number of times to count an abnormality is counted as one time.

The total number of times for abnormality determination is "2", and during monitor abnormality, the operation is executed.

#### MEMO

When the Abnormality Judgement Value is set as a "1", if the next Ping Monitoring Abnormality Condition is judged as "no abnormality", then the number of judging abnormality is cleared (back to "0").

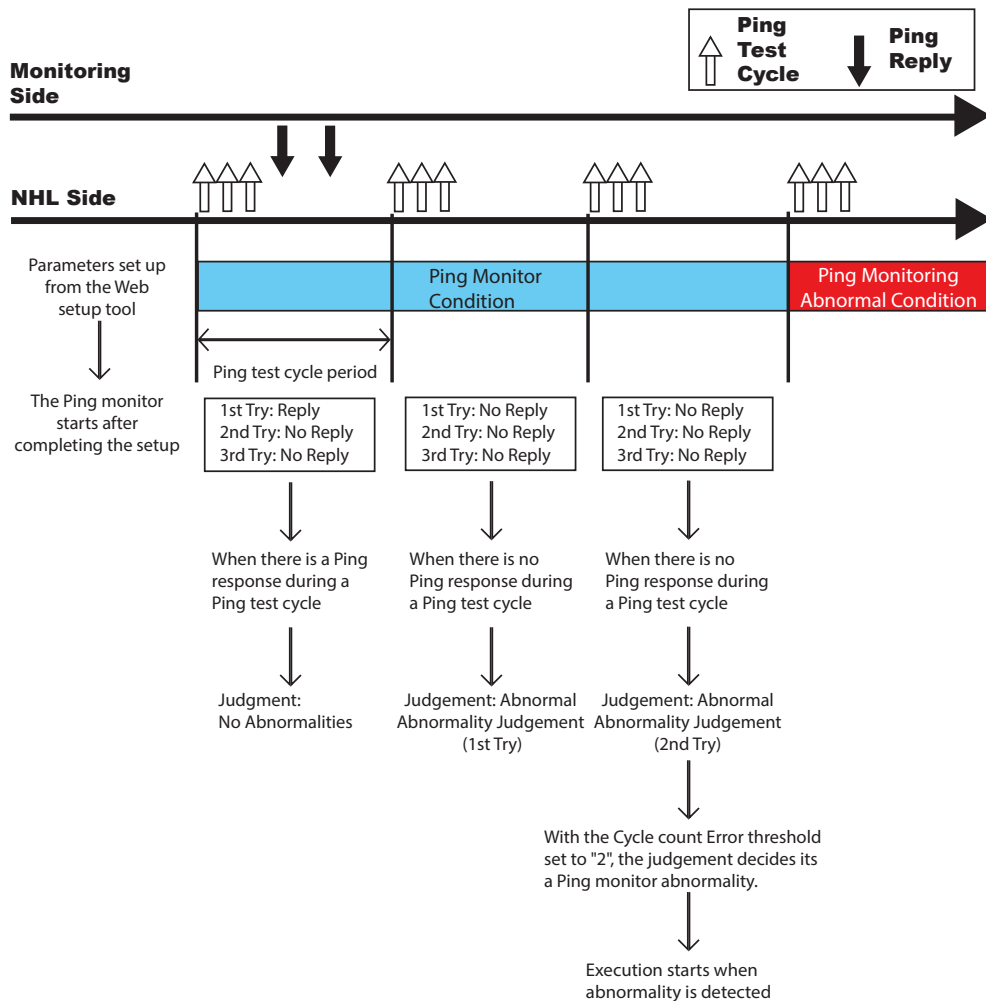

Figure 3.11.1-1 detailed sample image for Cycle count Error threshold of "2" and Pings per test cycle at "3"

**Attention**

- When the abnormality Recovery operation is performed, It is restored from the monitor abnormality status.
- If a "Clear" operation is performed when a monitor abnormality occurs, it is restored from its monitor abnormality status to a monitoring condition.

### 3.11.2. Ping Monitoring Function ("Clear" Command Outside Sources)

The following explains the operation when a "Clear" operation is received from the outside by the Ping monitoring function during monitor abnormality.

An example is when a "Clear" command is received from an outside source during a Ping monitor abnormality:

- ① . When a monitor abnormality from a monitoring condition is detected, the monitor abnormality operation occurs.
- ② . If a "Clear" command is received during the abnormality detection, the status of abnormality detection will be cleared and it will return to its normal mode.
- ③ . If there is a Ping response from the next Ping monitor execution, the monitoring condition will continue as normal.

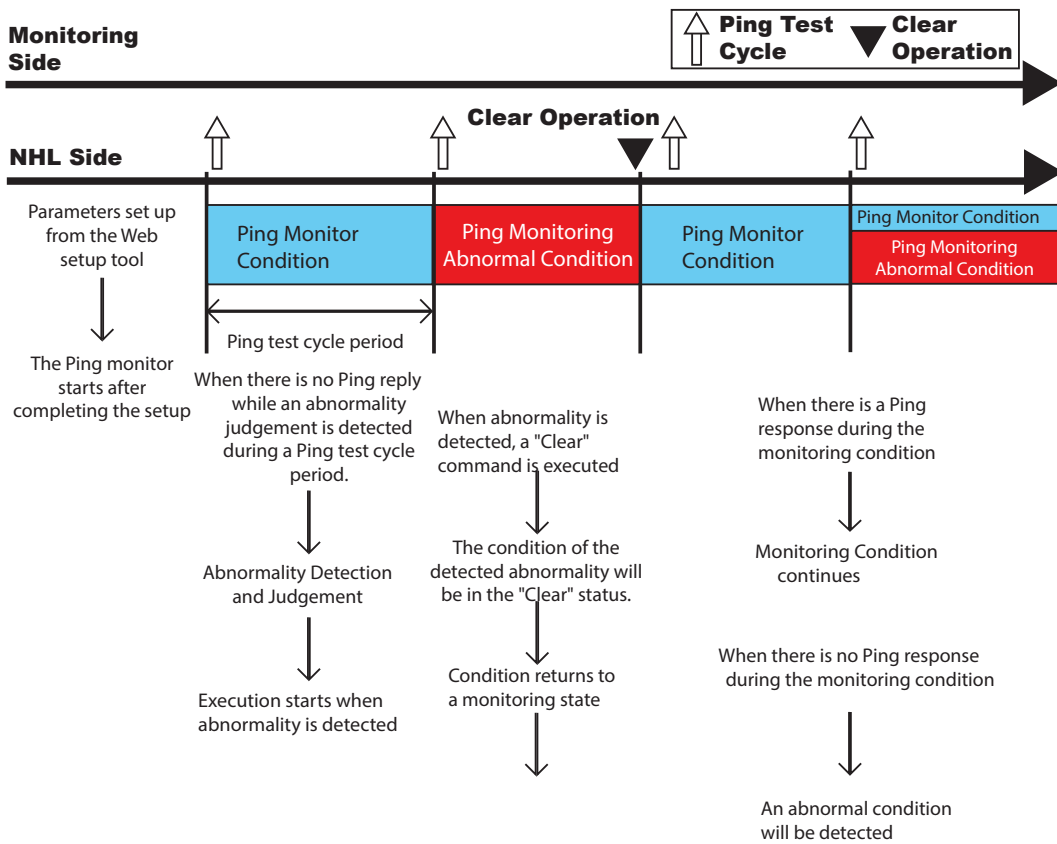

Figure 3.11.2-1 Detailed sample image of "Clear" operation received from the outside during monitor abnormality

**Attention**

In cases where it returns to a monitoring condition from a "Clear" command, it will not branch to the "Ping Recovery" operation from an abnormal detection.

## 3.12. Application Monitoring Function

By creating the additional transmission command ACK (06H) for a customer's application, this product can monitor the response of the application by receiving the data from it. If data is not received within the monitoring cycle period, it makes a judgement that the communication has become abnormal, and at the time of the abnormality, sends a status change to the Signal Tower. After a generated event, if data is received from the monitored candidate, it will detect a recovery from the abnormal operation.

Refer to "4.15 Application Monitoring Configuration Screen" for setting method details.

As an example, with a monitoring period of 30 seconds, the received data from the application is monitored.

- ① . After the setup is complete and it receives data from the address monitoring point, the monitoring will commence.
- ② . If data is received within the monitoring period of 30 seconds, it will be judged as having no abnormalities.
- ③ . However, if the data is not able to be received within the allotted period [30 seconds in this example], it makes a judgment of abnormality. Once judged as abnormal, the operation at the time of the detected abnormality is carried out.
- ④ . If data is received from the application after detecting a generated event of abnormality, it will detect a recovery from the abnormality. The operation at the time of recovery from the abnormal condition will return to its monitoring condition again.

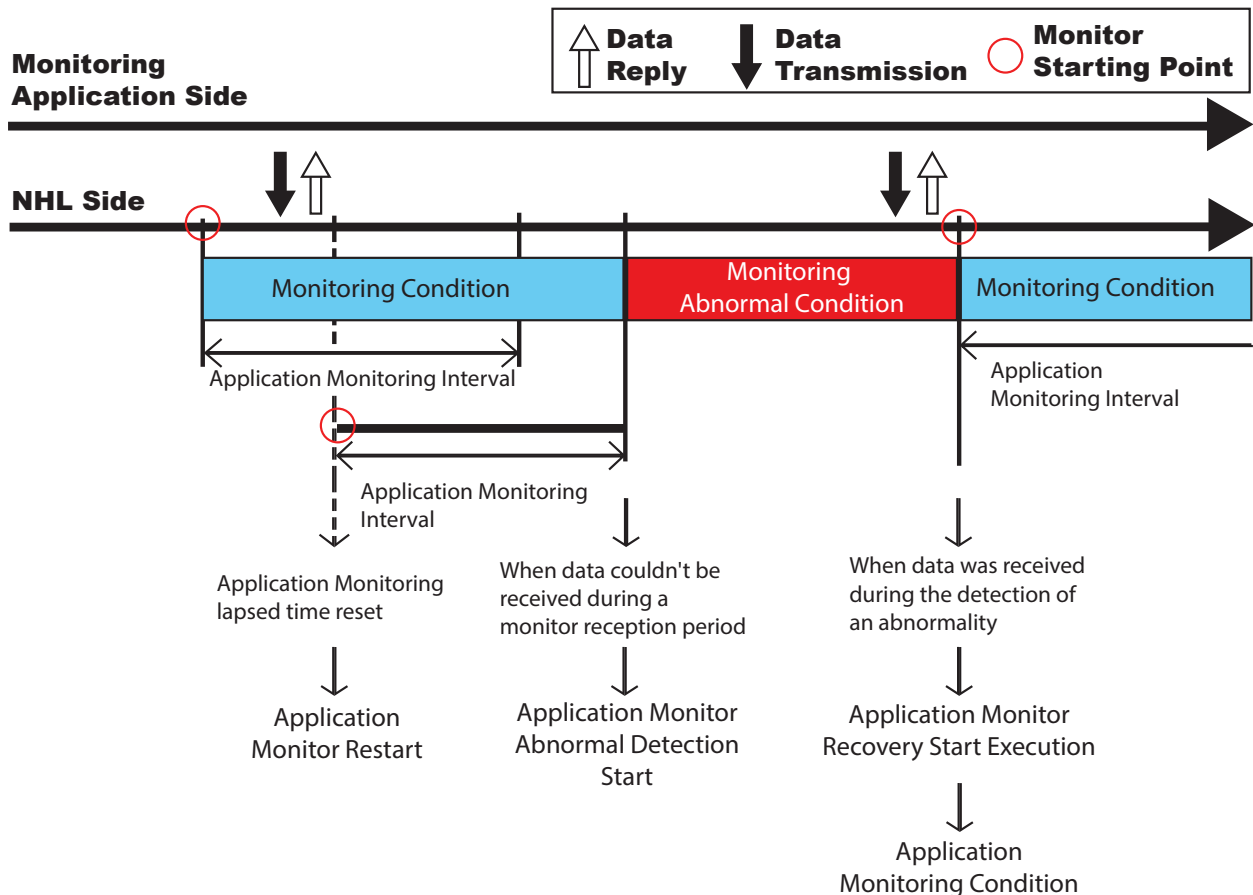

Figure 3.12.0-1 Example detail drawing of application monitoring operation

### Attention

- A monitor will be suspended, if a monitor is started from the time of receiving data and a connection is cut.
- Recovery from an abnormal operation can only occur if a monitored condition was detected as abnormal.
- Please transmit data to the receiving port of the application monitoring function of This product by a TCP protocol. It does not operate with UDP protocol.

### MEMO

It monitors by receiving arbitrary data.



### 3.13. SLMP Read Command Transmission Function

The device on the equipment designated for SLMP uses the command to acquire information from the device with periodic transmissions. When comparing the conditions based on the agreement conditions, if the acquired information agrees, the operation set for the condition is executed. In addition, if error data is received, the operation specified at the time of an error is executed. The operation based on a condition agreement can be set up for every device acquiring data. When an error occurs, the operation to handle an error can have a common setup for each device. The number of acquisition devices can be selected from one or two points. When using a bit device, use 1 bit or 2 bits; with a word device, a 1 or 2 word is acquirable. Refer to "4.19 SLMP Read Command Configuration Screen" for the setting method details.

The PLC device data is periodically checked.

Use other methods, such as PNS Commands or RSH Commands to acquire data.

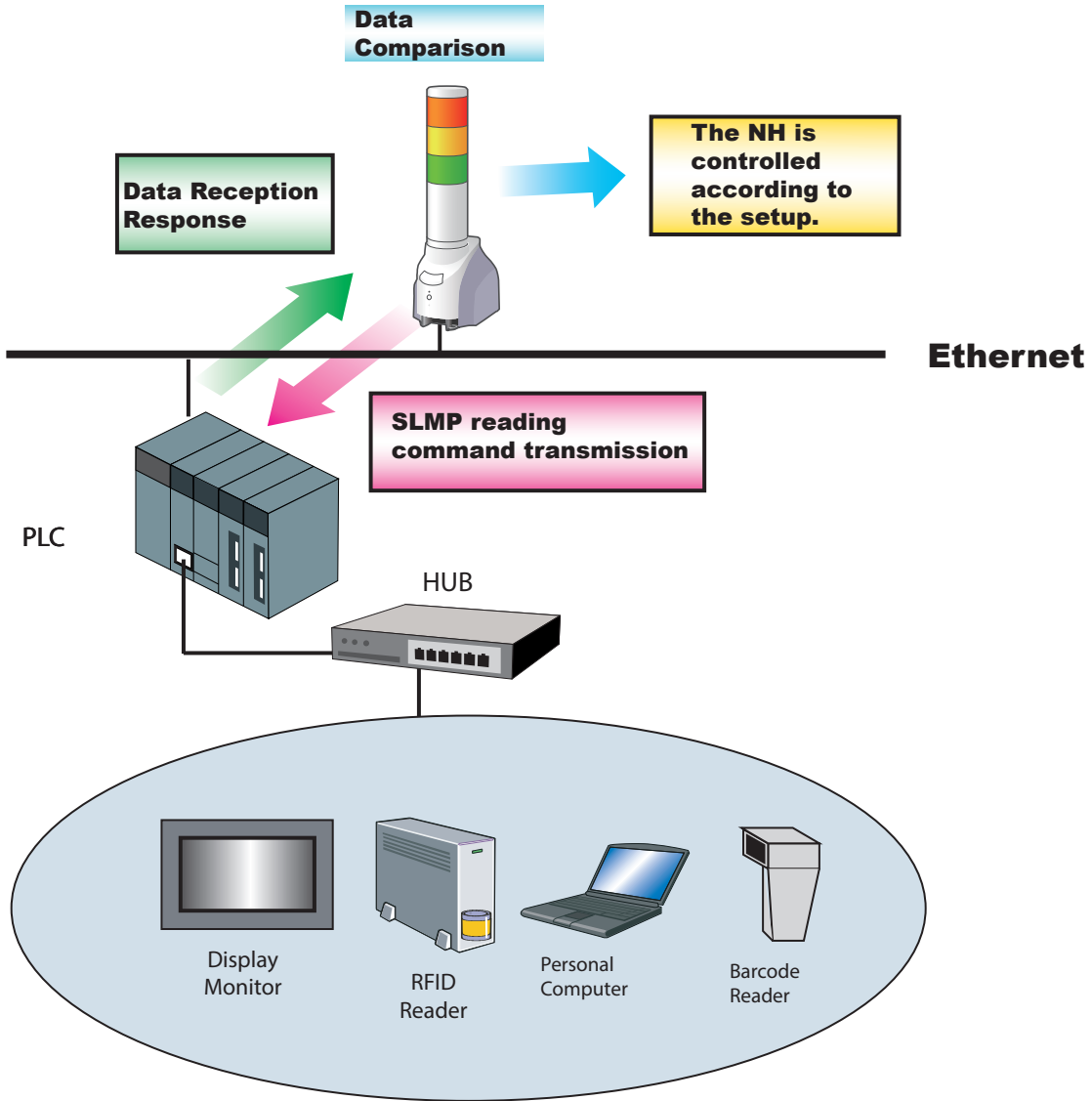

It is possible to use SLMP to acquire the device information on equipment connected to CC-LinkE or CC-Link.

**Attention**

- Prior to using this product, refer to the appropriate manual for instructions on how to setup connections for a master station, local broadcasting station, and intelligent device station.
- When a reset or reboot is done on SLMP compatible equipment, this product should also be rebooted.

### 3.13.1. SLMP Reading Command Transmission Process

The process for the Command Transceiver is in the order from number 1 to 16. When the protocol is set as TCP, connection processing is started from the first command transmission, and only the command transceiver process is performed afterward. If changed into the following status, the established transmission interval is opened and the following number for the command transceiver process is executed.

- The response data of the Command which was transmitted was received.
- The response data was not able to be received within the established timeout limit.
- The Command addressee was not established.

The next number of the command transceiver process after No. 16 is No. 1. If a timeout occurs, the cut-off process will occur and re-connection will proceed within the set transmission interval. The transmission interval can be selected from 10 ms, 50 ms, and 100 ms.

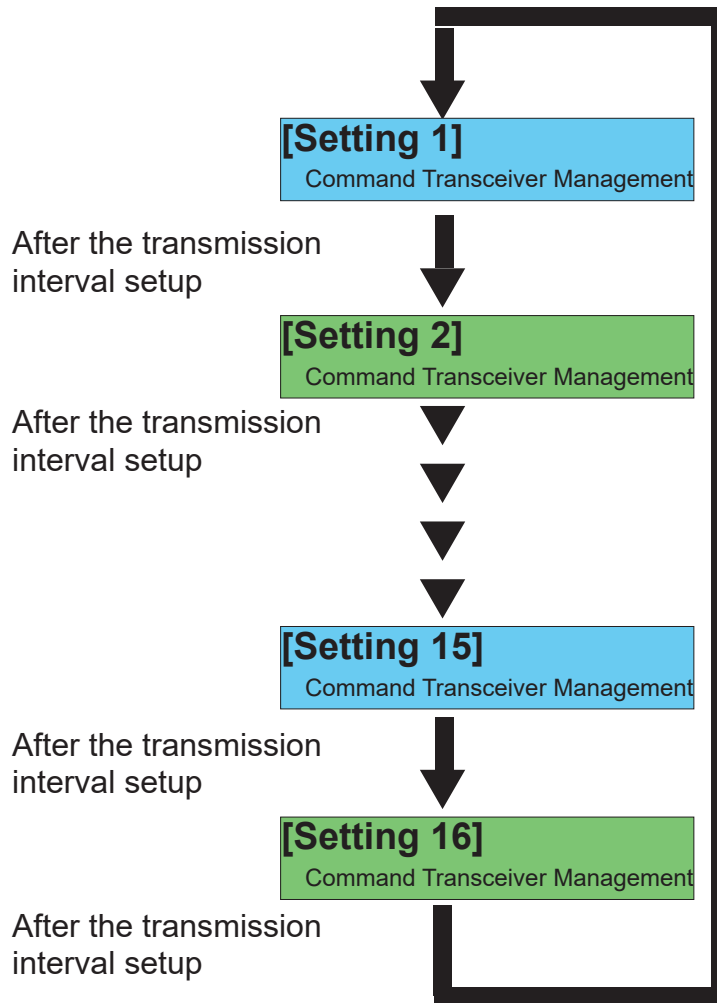

Figure 3.13.1-1 SLMP Reading Command Transmission Process

**Attention**

- Do not Send a Command transmission when the addressee and the address port number is not established.
- the shortest number of seconds for the transmission interval is set. Depending on the circumstances inside the product, a larger transmission interval might be set.

### 3.13.2. SLMP Read Command Transmitter Function Details (Conditions Agree)

Device information from SLMP corresponding equipment can be acquired. The comparison of the set agreement conditions for the acquired information is made and the operation of the Signal Tower occurs when the condition agreement is explained. If the conditions set up are in agreement, a condition agreement status is recognized. If the conditions in the acquired data agree in the condition agreement status, the Signal Tower does not operate. The condition agreement status is cleared when entering a "Clear" operation.

Example) When data and condition agreement from the SNMP Supported equipment is acquired:

- ① . If the contents is set for when the data acquired from the equipment corresponding to SLMP and product are in agreement, the Signal Tower performs its operation at the time of agreement.
- ② . If it agrees with the data acquired in the condition agreement status, the Signal Tower does not operate.
- ③ . If a "Clear" operation is received in the condition agreement status, the condition agreement status will be cleared and it will return to its monitoring condition.

If the data acquired does not agree on its conditions, it is cleared.

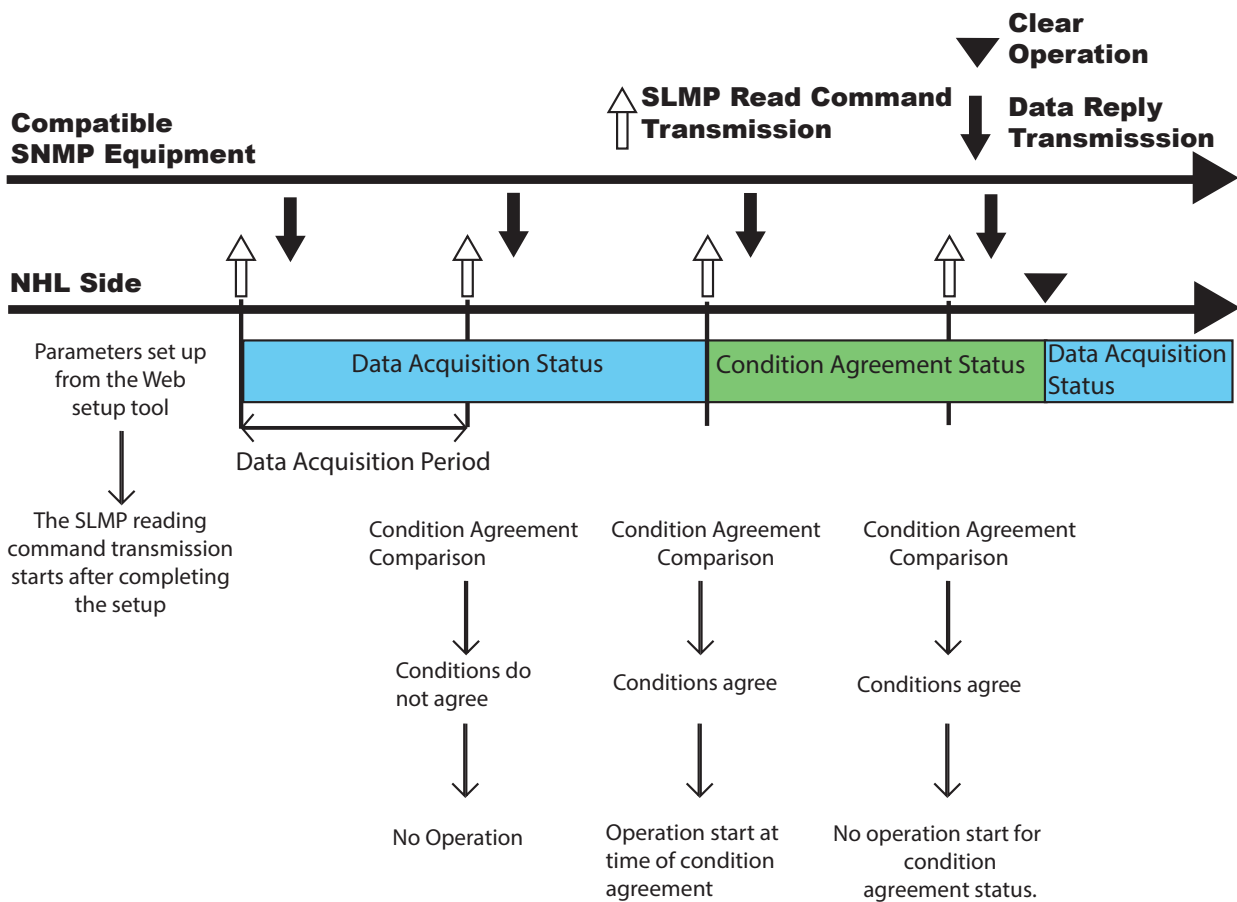

Figure 3.13.2-1 SLMP Reading Command Transmission Operation (Conditions Agree)

### 3.13.3. SLMP Read Command Transceiver Functional Details (Error Occurs)

The following explains the operation at the time of receiving error data from the equipment corresponding to SLMP. When acquired data information is errored, the operation of a Signal Tower can be set when the data error is received. If error data is received once, it is recognized as an error condition. If error data is acquired again in a data error status, the Signal Tower does not operate. An error condition is cleared by entering a "Clear" operation.

Example) When error data is acquired from the SLMP equipment:

- ① . If the data acquired from the equipment corresponding to SLMP has error data, the Signal Tower operates at the time of error-data reception.
- ② . If the error data is acquired again in a data error status, the Signal Tower does not operate.
- ③ . If a "Clear" command is received during a data error status, the data error status will be cleared and it will return to the data acquisition status.

In addition, if normal data is received during an error condition, the error condition is cleared and it returns to the data acquisition status.



**Compatible  
SNMP Equipment**

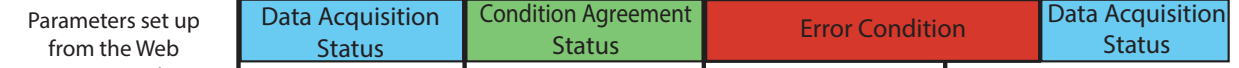

Parameters set up from the Web setup tool  
↓  
The SLMP reading command transmission starts after completing the setup

Data Acquisition Period

Condition Agreement Comparison  
↓  
Conditions agree  
↓  
Operation start at time of condition agreement

Received Data Error  
↓  
Operation start at time of error

Received Data Error  
↓  
No operation starts, due to error condition.

Figure 3.13.3-1 SLMP Reading Command Transmission Operation (Error Occurs)

### 3.14. SLMP Write Command Transmission Function

A SLMP write command can be transmitted when generating a "Clear" event. The addressee can register a maximum of four places, and can transmit individual command contents to each. The device can be selected to transmit from one or two points, and if the device is writing in bits, it would be a 1 or 2 bit value, and if set as a word device, one or 2 words of data can be transmitted.

Refer to "4.20 SLMP Write Command Configuration Screen" for the set up method.

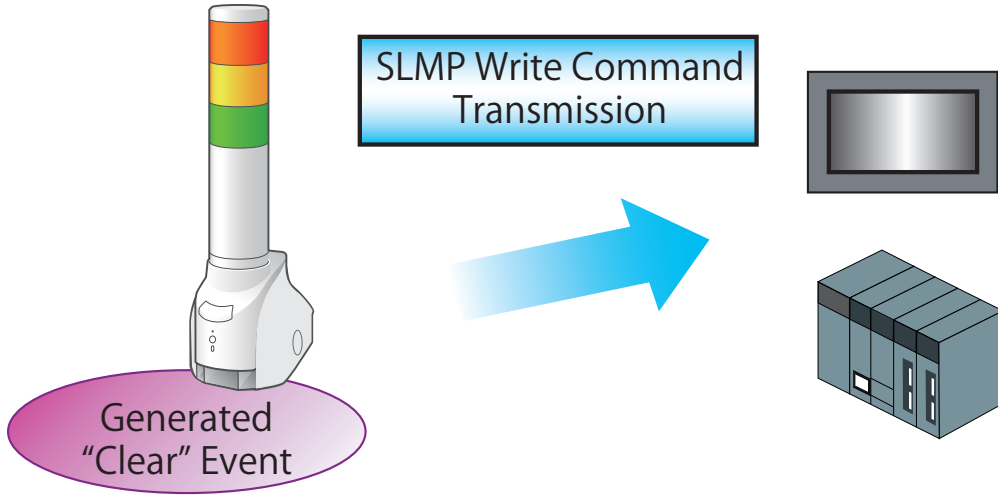

Table 3.14.0-1 SLMP Write Command Transmission Timing Event

Clear Event Transmission Timing Event
• When the "Clear" switch is pushed
• When a "Clear" from SNMP is done
• When a "Clear" command from RSH is executed

**Attention** If two or more addressees are established, the command transmission management selects one at a time from the low-priority in number order.

### 3.15. "Clear" Operation Function

The "Clear" operation function changes each function of this product to the following conditions. Refer to "Table 3.15.0-1" for the execution method of the "Clear" operation, and the status change for each function.

- Return the Signal Tower to its Normal operating condition.
- Turn the digital output mode into an OFF condition.
- Use the "Clear" operation to stop a playback function or playback memory channel in accordance to the operation settings.
- Stop the channel 61 (Buzzer Pattern 1) sound to return the Signal Tower to its normal operation status after the test function has completed its inspection.
- The time that was currently measured from the digital input condition setup function is reset.
- Return the monitor abnormality status to a monitoring condition in the application monitoring function.
- Returns the monitor abnormality status to a monitoring condition in the Ping monitoring function.
- Return the condition agreement status and Error data status to the data acquisition status for the SLMP monitoring function.

**Attention**

- Turn OFF an output terminal with the execution of a "Clear" operation function. Be careful when executing the "Clear" operation.
- When executing a "Clear" operation function during a monitoring condition, be sure to maintain the monitoring condition as is.
- When returning to a monitoring condition, It will not work for an abnormality recovery. Moreover, when the monitoring object is still in an abnormal condition, in accordance to the monitor set up, the monitor abnormality operation is performed again.

Table 3.15.0-1 "Clear" Operation Run-time Status Change List

"Clear" Method	•RSH Command Transmission a "clear" •SNMP SET Command [controlLightSnmpClear] equals 1	•PNS Command Transmission a Identifier "C" •Web Setup Tool "Clear" Execution •HTTP Command Transmission a "clear"	•Pressing the "Clear" button
Signal Tower	Normal Operation Status	Normal Operation Status	Operation setup executed
Digital Output	OFF	OFF	OFF
BUSY Output	OFF	OFF	Channel status: Playback: ON Stopped: OFF
Channel Playback	Stop	Stop	Changes based on setup
Test Operation	Stop	Stop	Stop
E-mail Transmission	Transmission Used	Unused	Transmission Used
TRAP Transmission	Transmission Used	Unused	Transmission Used
SLMP Writing	Transmission Used	Unused	Transmission Used
Ping Monitoring Abnormal Condition	Monitoring Condition	Monitoring Condition	Monitoring Condition
Application Monitoring Abnormal Condition	Monitoring Condition	Monitoring Condition	Monitoring Condition
SNMP Supported Monitor Function Condition Agreement Status	Status Continues	Status Continues	Status Continues
SLMP Read Command Condition Agreement Status	Data Acquisition Status	Data Acquisition Status	Data Acquisition Status
Digital Input Condition Setup	Measuring Time is Reset	Measuring Time is Reset	Changes based on setup

### 3.15.1. “Clear” Operation Execution

There are five methods to execute a "Clear" operation function.

- Execution from the Web Setup Tool (Refer to "4.23 Digital Input Condition Settings Screen")
- Pressing the "Clear" switch.
- RSH Command: Execution of "clear" and "doclear" (Refer to "3.10 RSH Command Function")
- PNS Command: Execution of a "Clear" operation command (Refer to "3.8 PNS Command Reception Function")

Product Classification "XX"		Identifier [C]	Empty	Data Size	
58H	58H	43H	00H	00H	00H

- Use an SNMP SET command with a "clearAction" value of "1" to clear. (Refer to "3.5.1 SNMP SET with Channel Playback")

Object	Object ID	Value
controlLightSnmpClear	1.3.6.1.4.1.20440.4.1.5.1.3	1

- HTTP Command: Execution of "clear" (Refer to "3.25 HTTP Command Control Function")

### 3.15.2. “Clear” Switch Operation Setting

The following items can be selected to execute a "Clear" operation when the switch is depressed.

- "Clear" Switch Function: Active/Inactive:
  - When Active: The "Clear" operation is executed upon the pressing of the "Clear" switch.
  - When Inactive: No "Clear" operation is executed, even if the "Clear" switch is pressed.
- Clear Tiers: Clearing all Tiers / 2-step Clear
  - When clearing all tiers:
    - The Signal Tower, Channel and Digital Output are simultaneously cleared when a "Clear" operation is executed.
  - When executing a 2-step "Clear":
    - Pressing the "Clear" switch the first time executes a clear operation of a channel.
    - The "Clear" operation will clear the relay contact when using the BUSY output mode.
    - Pressing the "Clear" switch the second time will clear the Signal Tower.
    - The "Clear" operation will clear the relay contact when using the digital output mode.
- Sound: Stop / sending music (when memory playback mode is selected)
- When a stop is used: Channel playback and BUSY output is suspended.
  - Channel memory is erased.
- When sending music: The channel which suspended the channel playback is registered into the channel memory and played back.
  - Channel playback is suspended when the channel memory becomes empty.
- Clearing the Signal Tower
  - When Active: The Signal Tower will switch off upon the pressing of the "Clear" switch.
  - When Inactive: The Signal Tower will not switch off, even if the "Clear" switch is pressed.

#### << Playback mode execution when pressing the "Clear" switch >>

When the "Clear" switch is pushed during channel playback and the operation changes the playback modes.

#### When the playback mode is "input priority playback mode"

When the "Clear" switch is pressed, channel playback is interrupted and the Busy output is turned off.

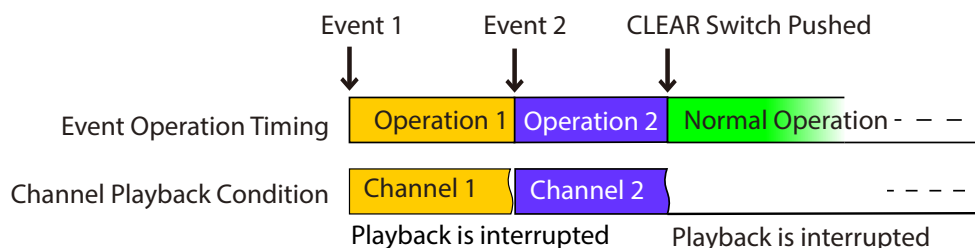

### When the playback mode is "memory playback mode"

In the memory playback mode, the "channel memory" setup changes with the "Clear Execution".

- When the setup is made to "stop"

If a stop is selected when the "Clear" switch is pressed, the channel in playback will be interrupted and the BUSY output will be suspended.

The channel registered in the channel memory is erased.

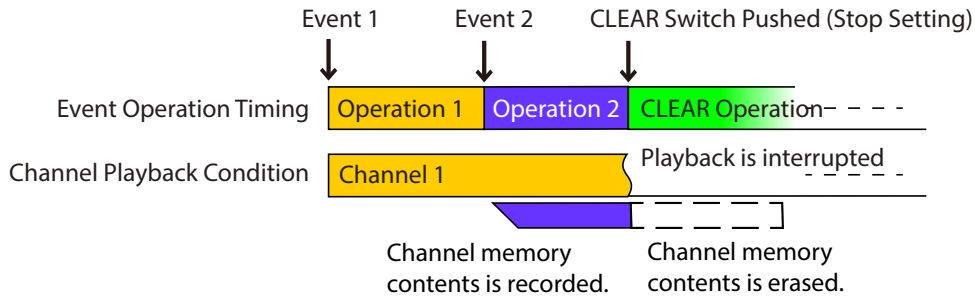

- When the setup is made for "sending music"

If "sending music" is selected when the Clear switch is pressed, channel playback will be interrupted, and the channel registered into the channel memory will be played back.

During the channel playback, the BUSY output also continues.

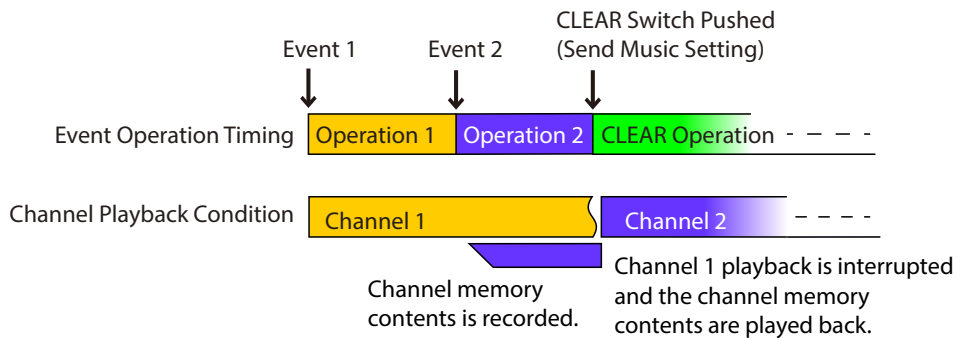



## 3.16. Digital Input Condition Setup Function

The status change of a digital input conditions are met when the set-up operation is set up to be executed. The digital input is detected as an ON condition. (Refer to "3.2.2 Digital Input Monitoring Function") Condition "Setup 1" through "Setup 4" serves as independent control and judgment.

The sequence for operation setup is "Setup 1" → "Setup 2" → ... → "Setup 4", and when the setup agrees, the operation is executed. (Priority is given to the last set up operation)

The following set up can be executed:

Table 3.16.0-1 Condition Pattern

Time Continuation Detection	When the fixed time input is set to be detected, it is considered as "Active." The number which can be set up is from 0 to 3600 seconds. It is inactive when 0 is used.
-----------------------------	---

Table 3.16.0-2 Operates when the "Clear" switch is pressed

"Clear" Condition	When the "Clear" switch is pushed, it is set up as to whether the measured detection time is reset. When it is set to "Active", the measured time is reset by pressing the "Clear" button. When it is set to "Inactive", the measured time is maintained, even after pressing the "Clear" button.
-------------------	---

Table 3.16.0-3 Operation After Condition Agreement

Re-detection	After a detection condition agrees, it is set up to detect again. When set to "does", it detects when detection conditions agree and operates. When set to "doesn't", after the setup, it only operates when the detection condition agrees at the beginning, and even if it agrees after that, it does not operate. When set to "doesn't", be sure to set the following operations to allow it to detect again: <ul style="list-style-type: none"> <li>• Execute a "Clear" operation. Refer to "3.15 "Clear" Operation Function".</li> <li>• Set the clearance condition to "Active", then press the "Clear" button.</li> <li>• Put a checkmark into the digital input "Clear" conditions setup to re-detect the "Clear" condition", then change the status of the digital input.</li> </ul>
--------------	--

Table 3.16.0-4 Condition Agreement Operation

Classification	Contents
Signal Tower Control	The Signal Tower can be controlled according to its setup.
Channel playback control	The channel playback can be controlled according to its setup.
Digital output control	The digital output will be ON or OFF.
TRAP Transmission	SNMP TRAP is transmitted to the set-up address of the equipment.
E-mail Transmission	E-mail is transmitted to the set-up mail server.

**MEMO**

- The detection delay for a digital input is 110 ms.
- The input trigger condition cannot be changed from a fixed on condition.

## 3.17. Reinitialization Function

From the Web Setup Tool, this unit can be reinitialized to revert all settings back to the default (factory) settings, while leaving the network settings as is when resetting the other settings. Refer to "3.17 Reinitialization Function" for more details.

The switch on this product can also be operated by the following methods, and only the network setup can be initialized to the factory default values. Refer to "3.22 Mode Switch Operating Functions" for more details.

### [Method for initialization, including the network setup]

- ① . Set the mode switch to "NORMAL".
  - ② . While pushing the test switch and reset switch simultaneously, insert the power source for this product.
  - ③ . If all the lights on the Signal Tower turns off, then release the switches.
  - ④ . After about 50 seconds, the Signal Tower does an all-points Light-up and re-initialization will occur with the "network setup back to factory default values. After re-initialization, a message will continuously play back to indicate the mode switch is to be returned to "NORMAL" and the Main Unit needs to be rebooted.
  - ⑤ . Do reclosing of the power source of this product, or push a reset switch.
  - ⑥ . Re-connect with the factory default IP address of "192.168.10.1".
- \* If the Ping monitor etc. are set up, an abnormal operation detection may occur.

### [Method for initialization to revert back to the factory default values]

- ① . Set the mode switch to "MODE2".
- ② . While pushing the test switch and "Clear" switch simultaneously, insert the power source for this product.
- ③ . If all the lights on the Signal Tower turns off, then release the switches.
- ④ . After about 50 seconds, re-initialization will occur and the setup will be back to factory default values. After re-initialization, a message will continuously play back to indicate the mode switch is to be returned to "NORMAL" and the Main Unit needs to be rebooted.
- ⑤ . After returning the mode switch to "NORMAL", push the reset switch or remove the power source to this product.
- ⑥ . Re-connect with the factory default IP address of "192.168.10.1".

Table 3.17.0-1 Setting after default function executed

Item	Execution Method				
	WEB Setup Tool			Mode Switch Functions	
	Checking network initialization	Checking playlist initialization	Not checking network/playlist	Only initializing network setup mode	Initialization Mode Values
Network Setup	Set to default	Setting is Saved	Setting is Saved	Set to default	Set to default
Password	Set to 'patlite'	Set to 'patlite'	Set to 'patlite'	Set to 'patlite'	Set to 'patlite'
Setup (excluding Password & Network) Menu	Set to default	Set to default	Set to default	Setting is Saved	Set to default
Operation Settings	Set to default	Set to default	Set to default	Setting is Saved	Set to default
Event Log	Erased	Erased	Erased	Erased	Erased
MP3 Data (Channels 01-30)	Setting is Saved	Erased	Setting is Saved	Setting is Saved	Setting is Saved
MP3 Data (Channels 31-60)	Erased	Erased	Erased	Setting is Saved	Erased

#### Attention

- When initializing with the switch operation, the playback guidance sound explains the operation method. Be sure to adjust volume so that the guidance Sound can be clearly heard before proceeding with the operation.
- Do not overexert pressure to the "Clear" switch, test switch or mode switch. Failure to comply will result in product damage.
- Setup and Log data, etc., cannot be restored when executing "Network Setup Initialization Mode" or "Initialization Mode". Before initialization, be sure to backup any necessary setup information and log data.

#### MEMO

"Network Setup" refers to the "IP address for this product, Net Mask, Default Gateway, DNS server address and Host Name" parameters in the System Setup Screen.

## 3.18. Configuration Data Save/Load Setup

The setting menu for this product can be read out and saved as configuration data on the PC. The read configuration data can be selected and can be written into this product. The Configuration Save/Load Setup can be done from the Web setup tool, or by the use of the switches on this product. Configuration data can be read into the PC or saved in the PC from the Web setup tool. Refer to "4.29 Configuration Data Setup Screen" for more details.

When operating the switch on this product, it can change the mode switch for the read-out of configuration data and can save the configuration data in the USB memory for this product. Refer to "3.21 USB Memory Function" and to "3.22 Mode Switch Operating Functions" on pg. 84 for more details.

## 3.19. Event Log Output Function

The Web Setup Tool displays an event log. Moreover, it is possible to download it as a text file. The following is the description of the recording mode labels for the event log.

Displayed Event Name	coldStart	Displayed Event Contents	No Display
Event Details	Records from the start up time.		
Displayed Event Name	ACCESS	Displayed Event Contents	No Display
Event Details	Records at the moment of authentication failure. • At the moment of a Web login failure		
Displayed Event Name	MAIL	Displayed Event Contents	E-mail Transmission
Event Details	Records at the moment of an E-mail transmission.		
Displayed Event Name	TRAP	Displayed Event Contents	Trap reception IP address and the designated sender
Event Details	When a registered Trap is received, it is recorded with the IP address of the designated sender.		
Displayed Event Name	PING	Displayed Event Contents	Ping monitor abnormalities and the IP address object Ping abnormality response and the IP address object
Event Details	It records when the Ping monitor status changes. [Ping Monitoring Error] : It records with the target IP address when an abnormality event in the Ping monitor occurs. [Ping Recovery] : It records with the target IP address when an abnormality in the Ping monitor is restored.		
Displayed Event Name	APL	Displayed Event Contents	Application Monitoring Error Applicaton Recovery
Event Details	It records when an abnormality in the application monitor is detected. [Application Monitoring Error] : It records when an abnormality in the application monitor is detected. [Applicaton Recovery] : It records when an abnormality in the application monitor is recovered.		
Displayed Event Name	CLEAR	Displayed Event Contents	"CLEAR' Switch" "SNMP" The "RSH" IP address and the designated sender "PNS Command" "Web Setup Tool" "HTTP Command"
Event Details	The Signal Tower is returned to its normal operating status during operation. [CLEAR' Switch] : It records when the clear switch to this product is pushed. [SNMP] : It records when a "CLEAR" has been executed by the SNMP Command (controlLightSnmpClear). [RSH] : It records when a "CLEAR" has been executed by the RSH Command, and displays the designated sender IP address. [PNS Command] : It records when a "CLEAR" has been executed by the PNS Command. [Web Setup Tool] : It records when a "Clear" has been executed from the Signal Tower operation screen. [HTTP Command] : It records when a "clear" has been executed by the HTTP Command.		
Displayed Event Name	RSH	Displayed Event Contents	IP address, command argument, and the "alert" designated sender "Status" "Test" IP address, command argument, and the "sound" designated sender Designated sender IP address and "Stop" *
Event Details	It records when the RSH Command is executed. (The "Clear" execution is not included) [ALERT] : When the "alert" command is executed, it records the argument and designated sender IP address. [Status] : The "status" command is recorded at the time of execution. [TEST] : The "test" command records at the time of execution. [Sound] : When the "sound" command is executed, it records the sound argument and designated sender IP address. [Stop] : When the "stop" command is executed, it records the designated sender IP address. * An IP address is not written in cases where the designated sender address is inactivated.		
Displayed Event Name	SNMP	Displayed Event Contents	The index value of "CONTROL" and OID, or the SET value
Event Details	It records when theSNMP SET Command operation of this product is executed. controlLightControlState, controlSoundChannel, and controlSoundLight are the recorded objects.		

Displayed Event Name	SLMP	Displayed Event Contents	"SLMP Condition Agreement" "SLMP Error Reply"
Event Details	It will record, depending on the SLMP Operation *: A corresponding setup number is entered. [SLMP Condition Agreement *] : When the setup conditions agree with the operation, it is recorded. [SLMP Error Reply *] : When an error reply occurs, it is recorded.		
Displayed Event Name	SNMPGET	Displayed Event Contents	"SNMP Condition Agreement" "SNMP Condition Release" "SNMP Change Detection"
Event Details	It will record, depending on the Supported equipment SNMP Monitor Operation. *: A corresponding setup number is entered. [SNMP Condition Agreement *] : It records, depending on the condition agreement operation. [SNMP condition canceled *] : It records, when the condition is canceled. [SNMP Change Detection *] : When it operates by a Change Detection, it is recorded.		
Displayed Event Name	DIN	Displayed Event Contents	The "digital input operation" port number, status and digital input
Event Details	[DIN] : When it changes to the status for the digital input set up signal definition, it is recorded. Both the digital input port number (DI1-DI4) and the digital input status (ON/OFF) are recorded.		
Displayed Event Name	COND	Displayed Event Contents	"Digital input condition operation" and port number
Event Details	It will record, depending on the digital input condition agreement. *: A corresponding setup number is entered. [Digital input Condition Operation *] : It records, depending on the abnormality detection operation.		
Displayed Event Name	HTTP	Displayed Event Contents	"CONTROL"
Event Details	It records when the HTTP Command is executed. (The "clear" execution is not included)		

\* Displayed events within the square brackets or double quotes are not recognized in the log.

## 3.20. XML Data Output Function

The digital output status for this product is acquirable from an XML data format. Two kinds of XML data acquisition methods are indicated below.

- Go to [http://IPAddress/cgi-bin/xml\\_get.cgi](http://IPAddress/cgi-bin/xml_get.cgi) to access and acquisition data.
- Download an XML file from the "XML Data" screen of a Web setup tool.

### MEMO

- When XML data is acquired, set up the XML file output to "Active".
- when accessing the URL to acquire XML data, login certification can be made. Except for when using it in a safe Network, it is recommended to use the login certification when considering security.
- Refer to the "4.27XML setting screen" for the Setup method.

XML data can be obtained in the format shown below:

```
<?xml version="1.0" encoding="utf-8"?>
<signaltower>
  <color>
    <color name="LED1" value="0"/>
    <color name="LED2" value="0"/>
    <color name="LED3" value="0"/>
    <color name="LED4" value="0"/>
    <color name="LED5" value="0"/>
  </color>
  <sound>
    <sound name="SOUND" value="0"/>
  </sound>
  <port>
    <port name="DO-1" value="0"/>
    <port name="DIN-1" value="0"/>
    <port name="DIN-2" value="0"/>
    <port name="DIN-3" value="0"/>
    <port name="DIN-4" value="0"/>
  </port>
</signaltower>
```

Figure 3.20.0–1 Digital Output XML Data Format

Table 3.20.0–1 XML Data Item and Explanation

Classification	Description
color name	The Signal Tower color is shown. The corresponding color is as follows: LED1: Red, LED2: Amber, LED3: Green, LED4: Blue, LED5: White
sound name	The channel during playback is shown.
port name	The digital input/output port is shown. DO-1: Digital Output Port    DIN-1 to DIN-4: Digital Input Ports 1 to 4
color value	The Signal Tower status is shown. The corresponding status is as follows: 0: Not Lighting, 1: Lighting, 2: Flashing Pattern 1, Flashing Pattern 2
sound value	The channel numbers 1-70 during playback is shown. When it is stopped, it returns to zero (0).
port value	The status of each port is shown. 0: OFF    1: ON

## 3.21. USB Memory Function

By connecting a USB memory to the USB connector in the back of this product, firmware updates, log storage, configuration data uploads and downloads can be done.

### Attention

- It is necessary to format a USB memory in FAT or FAT32 and to have the appointed folder structure made in advance. The USB memory cannot be partitioned.
- It may not function properly if connected to a USB-HUB.
- It takes about 5 seconds after connecting a USB memory to this product until it is recognized. The time until it is recognized depends on the type of USB memory which is being connected, so it may take longer.

### << USB Memory Operation Functions >>

Table 3.21.0-1 USB memory Operation Functions

Function	Details
Firmware Update Function	Firmware updates can be done from the USB memory. Be sure to change the firmware update file name to "nh_update" before executing the update.
Event Log Function	An event log can download from this product onto USB memory. The file name to download is "logdata.txt."
Configuration Setting Function	Configuration data can be uploaded from the USB memory to the Main Unit. The configuration file name to download is "config_w.ini." Configuration data can be downloaded from the Main Unit to the USB memory. The configuration file name to download is "config.ini".
Playlist Package Load Function	A Playlist Package can be loaded into this product from USB memory. Be sure to change the Playlist Package name to "playlist.pkg" before loading the data.

### << USB Memory Folder Structure >>

In order to use the USB memory for this product, build the following folder structure.

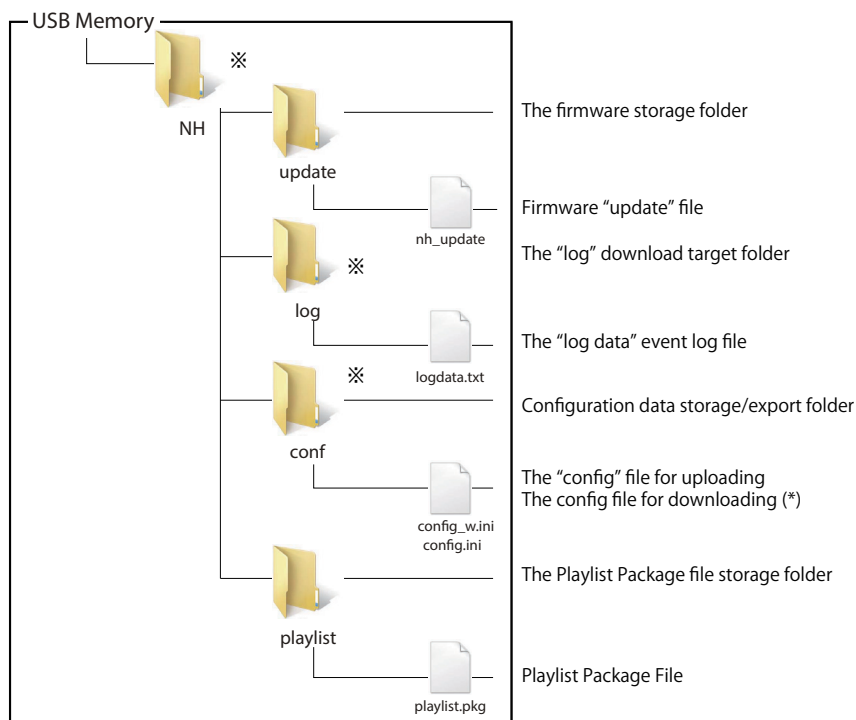

\* The folder and files marked with an asterisks are automatically generated, when each data file is downloaded.

Figure 3.21.0-1 USB Memory Folder Structure

### Attention

Enter the USB memory folder name and file name, using half-width alphanumeric characters. Since it is case sensitive, refer to Figure. 3.21.1 when entering folder and file names.

## 3.22. Mode Switch Operating Functions

The mode switch on the front of this product can be used to change the operating mode of this product. Use the mode switch when the Web setup tool cannot be used.

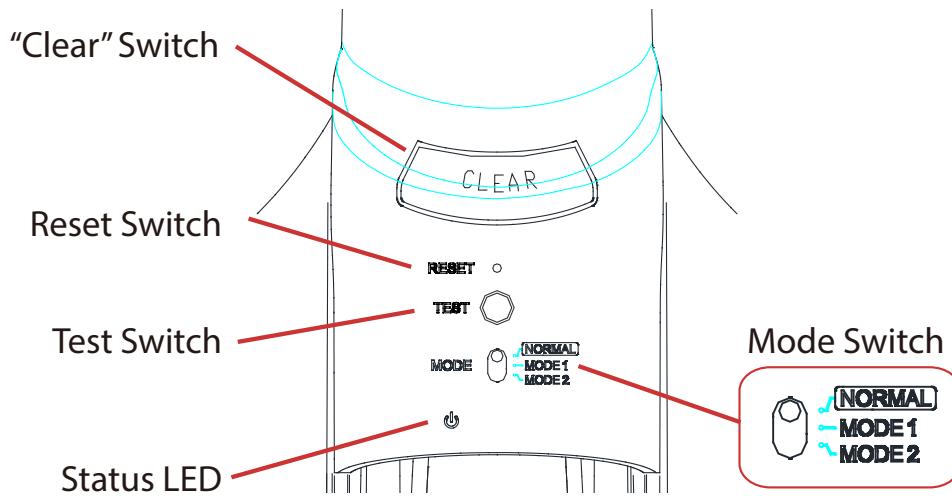

Table 3.22.0-1 Main Unit Mode Initialization List

Mode Name	Operating Method	Operating Function
Normal Mode	Mode Switch to "NORMAL"	Set up for normal operating conditions.
Network Set-up Initialize Mode	Mode Switch to "NORMAL", press the "Test" Switch	Only the network setup and password are initialized.
Factory Initialize Mode	Mode Switch to "MODE2", simultaneously press the "Clear" and "Test" switch	It initializes everything except the Playlist Package channel information.
DHCP Mode	Mode Switch to "MODE1", press the "Test" switch	A DHCP client is Activated.

Table 3.22.0-2 Main Unit Mode List Reboot with USB memory connection made

Mode Name	Operating Method	Operating Function
Playlist Upload Mode	Mode Switch to "MODE1"	The Playlist Package in the USB memory is uploaded to the Main Unit.
Configuration Upload Mode	Mode Switch to "MODE2"	The configuration data in the USB memory is uploaded to the Main Unit, and the setup is changed.
Firmware Update Mode	Mode Switch to "MODE1", press the "Clear" switch	The firmware in the USB memory is uploaded to the Main Unit, and the firmware is updated.

Table 3.22.0-3 Main Unit Mode List for USB memory connection at normal operation

Mode Name	Operating Method	Operating Function
Event Log Download Mode	Mode Switch to "MODE1"	The event log from the Main Unit is loaded onto the USB memory.
Configuration Download Mode	Mode Switch to "MODE2"	From a setup made by the Main Unit, the configuration data is exported from the Main Unit into the USB memory.

### Attention

- Setup and Log data, etc., cannot be restored when executing "Network Setup Initialization Mode" or "Initialization Mode". Before initialization, be sure to backup any necessary setup information and log data.
- For every mode, a guidance announcement is played to explain the operation method for each mode. Before switching the mode, be sure that the volume knob (body side) and master volume (WEB Setup Tool) are adjusted so that the guidance sound can be clearly heard.
- Do not overexert pressure to the "Clear" switch, test switch or mode switch. Failure to comply will result in product damage.



## << Network Set-up Initialization Mode >>

- ① . Set the mode switch to "NORMAL".
- ② . Push the test switch while booting up the Main Unit.  
Release the switch after the Signal Tower turns all Lights on.

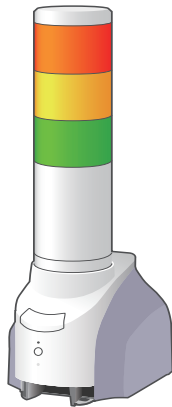
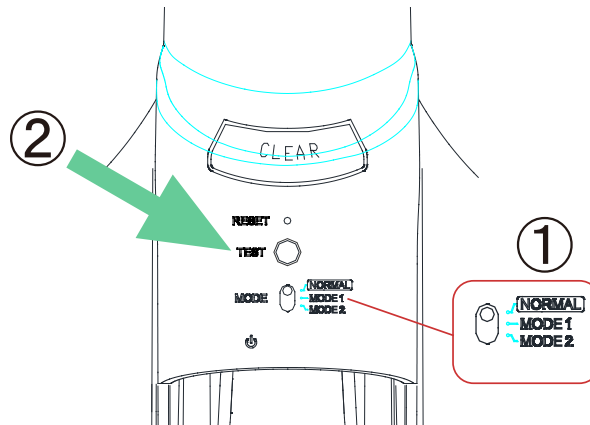

All Flashing  
↓  
All Off  
(During network set-up initialization)

- ③ . After about 50 seconds, the Signal Tower lights up all tiers, with an indication that re-initialization is complete with the message, "The network setup was initialized. Please reboot the Main Unit." repeating until the Main Unit is rebooted. Therefore, please reboot the Main Unit.

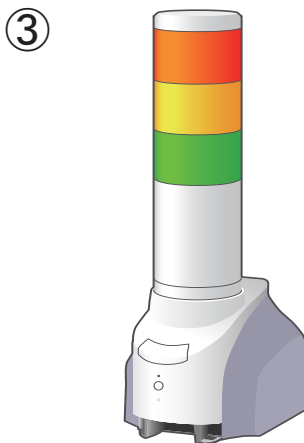

All Flashing (Initialization Completed)  
Guidance Message Playback

### MEMO

- When changing to the mode which can be done when starting up the Main Unit, remove the power source first, then reconnect, or press the reset switch on the front to reboot.
- In this mode, a guidance announcement is made to indicate that the operation was completed. Be sure to adjust volume so that the guidance sound can be clearly heard before proceeding with the operation.

## << Initialization Mode >>

- ① . Set the mode switch to "MODE2".
- ② . Reboot the Main Unit by pushing the "Clear" and test switch simultaneously. Release the switch after the Signal Tower turns all Lights on.

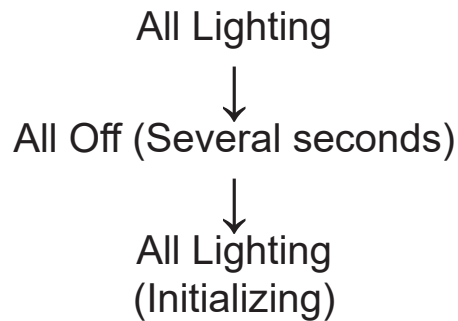
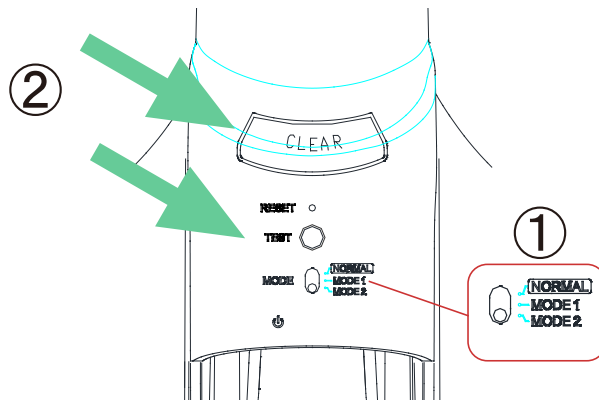

- ③ . After about 50 seconds, the Signal Tower lights up all tiers, with a message "The setup was initialized. Return the mode switch to the "NORMAL" position and reboot the Main Unit." repeating to indicate the mode switch is to be returned to "NORMAL" and the Main Unit needs to be rebooted. Therefore, return the mode switch to the "NORMAL" position and reboot the Main Unit.

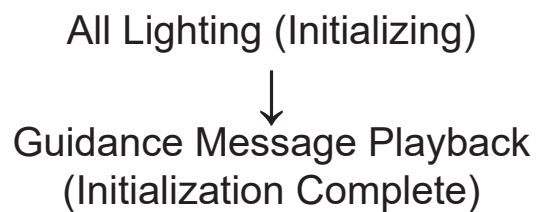
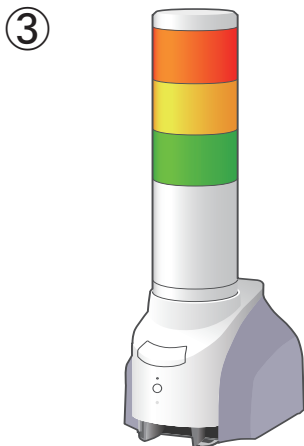

### MEMO

- When changing to the mode which can be done when starting up the Main Unit, remove the power source first, then reconnect, or press the reset switch on the front to reboot.
- In this mode, a guidance announcement is made to indicate that the operation was completed. Be sure to adjust volume so that the guidance sound can be clearly heard before proceeding with the operation.

## << DHCP Mode >>

- ① . Set the mode switch to "MODE1".
- ② . Push the test switch while booting up the Main Unit. Release the switch after the Signal Tower turns all Lights on.

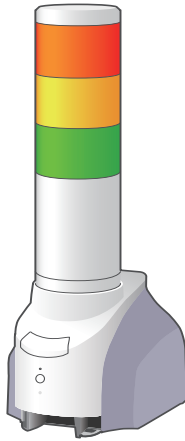

All Lighting  
↓  
All Off  
(Initiating DHCP Mode switchover)

- ③ . After about 50 seconds, the Signal Tower lights up all tiers, with a message, "The DHCP client function was enabled. Return the mode switch to the "NORMAL" position and reboot the Main Unit." repeating to indicate the mode switch is to be returned to "NORMAL" and the Main Unit needs to be rebooted. Therefore, return the mode switch to the "NORMAL" position and reboot the Main Unit.

③

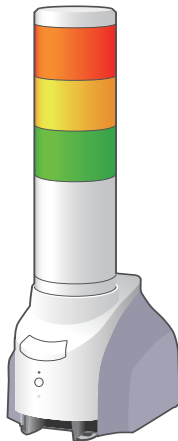

All Off  
(Initiating DHCP Mode switchover)  
↓  
All Lighting (Initialization Complete)  
(Initialization Complete)

## < When a writing error occurs >

The Signal Tower will flash pattern 2, and repeat playback will sound indicating the contents of the error that occurred. Correct the error in accordance to the contents of the error as indicated below.

- "An error occurred during the network set-up".  
→ Check whether the DHCP server being connected on the network exists.

## << Playlist Upload Mode >>

1. Connect the USB memory.

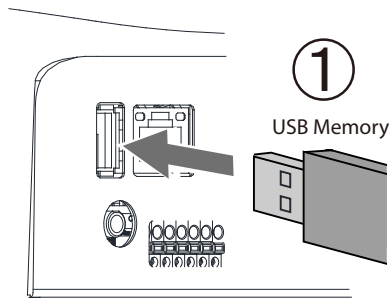

2. Set the mode switch to "MODE1" and start up the Main Unit.

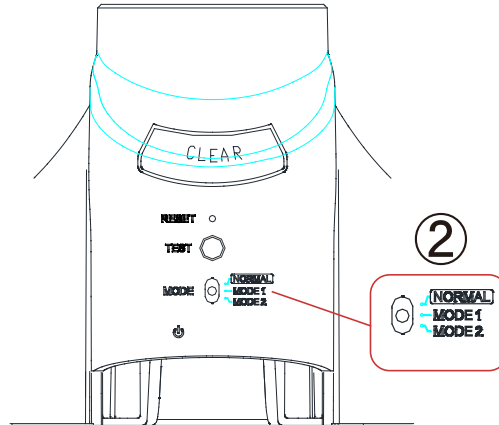

3. After about 50 seconds, the Signal Tower lights up all tiers, with a message, "The playlist data is being stored. Please push the "Test" switch." repeated until the test switch is pushed. Therefore, push the test switch. The Signal Tower flashes pattern 1 while writing is being done.

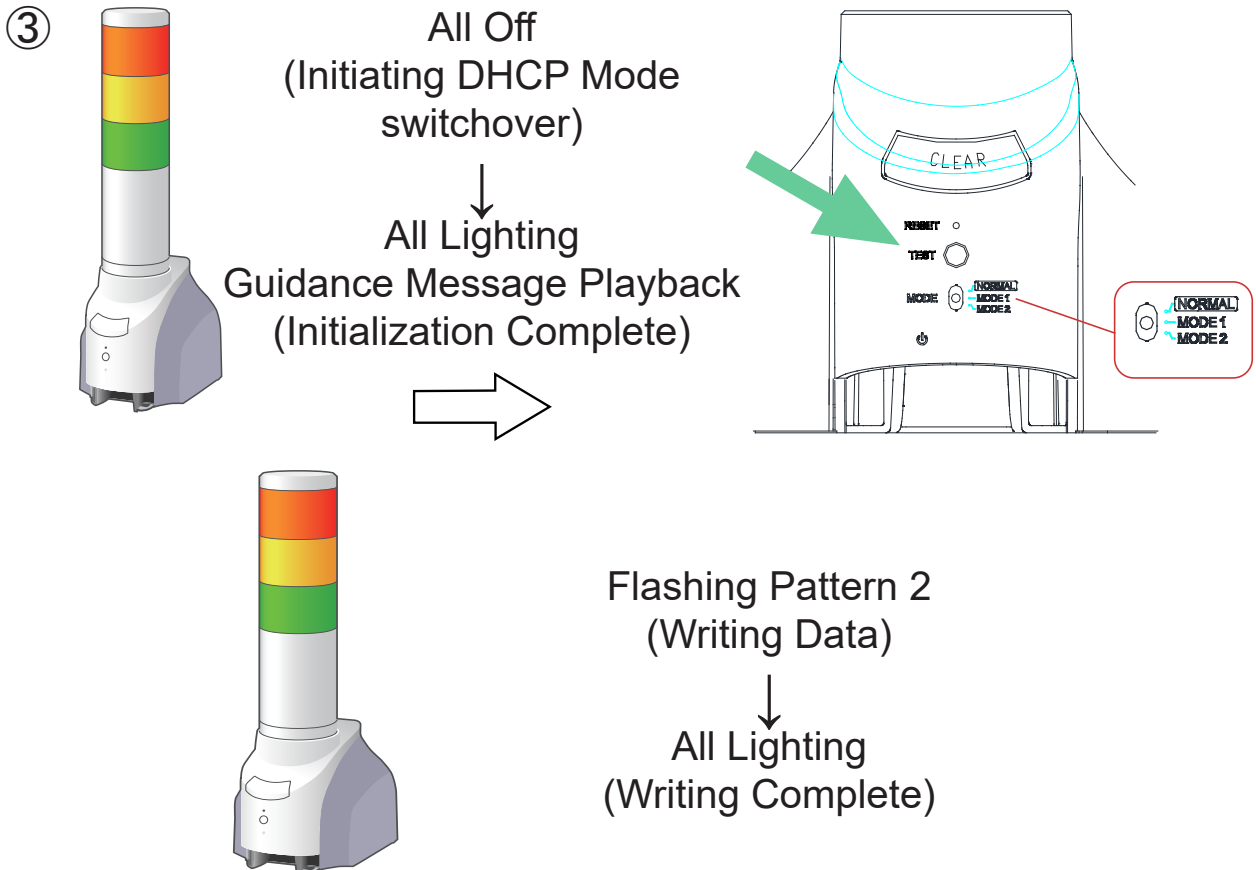

- ④ . If writing is completed, the Signal Tower lights up all tiers, with a message, "The playlist data was stored. Return the mode switch to the "NORMAL" position and reboot the Main Unit." repeated until the mode switch is returned to "NORMAL" and the Main Unit is rebooted.  
Set the mode switch to "NORMAL" and extract the USB memory before rebooting the Main Unit.

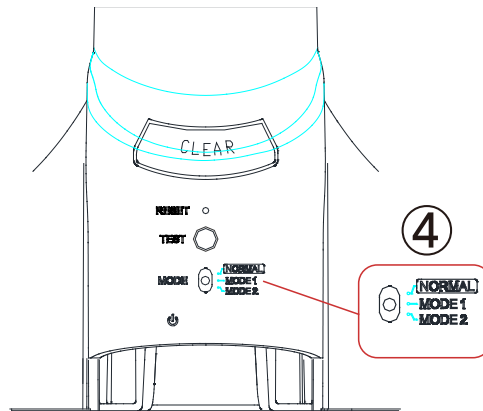

### < When a writing error occurs >

The Signal Tower will flash pattern 2, and repeat playback will sound indicating the contents of the error that occurred. Correct the error in accordance to the contents of the error as indicated below.

- "The USB memory file system is not recognized".  
→ Check whether the format for the SD card is FAT or FAT32.
- "The USB memory does not contain any data".  
→ Save the Playlist Package in the correct folder after referring to "3.21 USB Memory Function".
- "A writing error occurred when storing."  
→ The USB memory and/or playlist data may be corrupted. Save the data in another USB memory and try from step (1) again.

#### MEMO

When changing to the mode which can be done when starting up the Main Unit, remove the power source first, then reconnect, or press the reset switch on the front to reboot.

## << Configuration Upload Mode >>

- ① . Connect the USB memory.

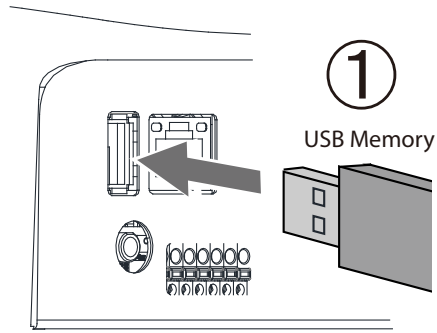

- ② . Set the mode switch to "MODE2" and start up the Main Unit.

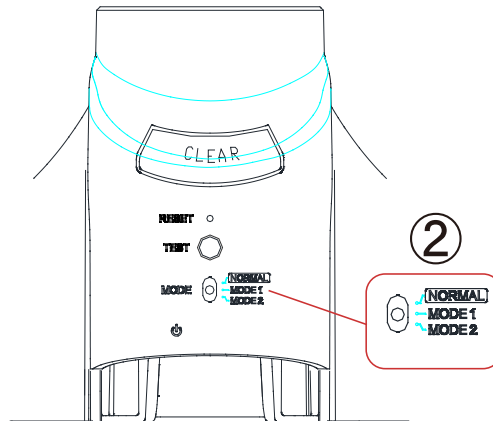

- ③ . After about 50 seconds, the Signal Tower lights up all tiers, with a message, "The setup information was stored on this machine. Please push the "Test" switch." repeated until the test switch is pushed. Therefore, push the test switch.

The Signal Tower flashes pattern 1 while writing is being done.

③

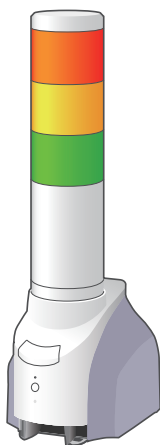

« All Lighting

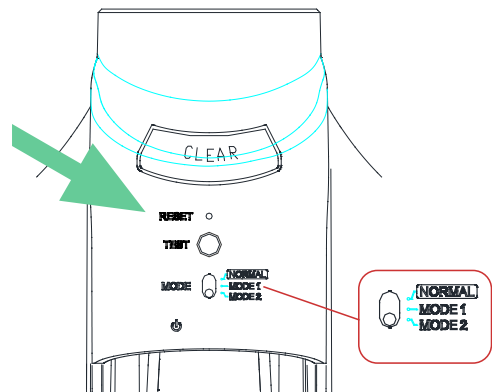
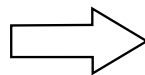

**MEMO**

When changing to the mode which can be done when starting up the Main Unit, remove the power source first, then reconnect, or press the reset switch on the front to reboot.

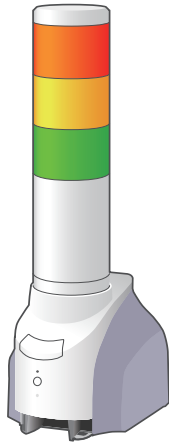

« Flashing Pattern 1

(Writing Data)



All Lighting  
(Writing Complete)

3

- ④ . If writing is completed, the Signal Tower will do an all-points Light check to indicate the firmware update was completed. Return the mode switch to the "NORMAL" position and reboot the Main Unit." repeated until the mode switch is returned to "NORMAL" and the Main Unit is rebooted.

Set the mode switch to "NORMAL" and extract the USB memory before rebooting the Main Unit.

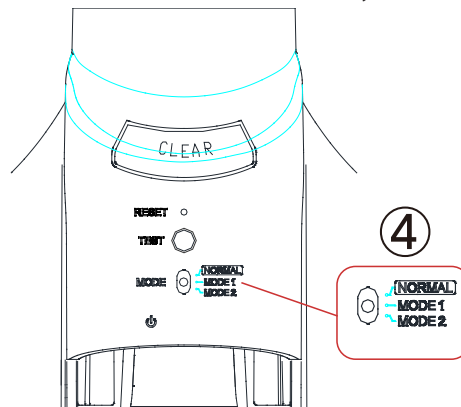

< When a writing error occurs >

The Signal Tower will flash pattern 2, and repeat playback will sound indicating the contents of the error that occurred. Correct the error in accordance to the contents of the error as indicated below.

- "The USB memory file system is not recognized".  
→ Check whether the format for the SD card is FAT or FAT32.
- "The USB memory does not contain any data".  
→ Save the Playlist Package in the correct folder after referring to "3.21 USB Memory Function".
- "A writing error occurred when storing".  
→ The USB memory and/or playlist data may be corrupted. Save the data in another USB memory and try from step (1) again.

## << Firmware Upload Mode >>

- ① . Connect the USB memory.

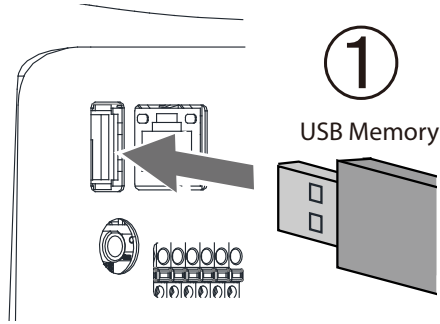

- ② . Set the mode switch to "MODE1", and start up the Main Unit while pushing the "Clear" switch.

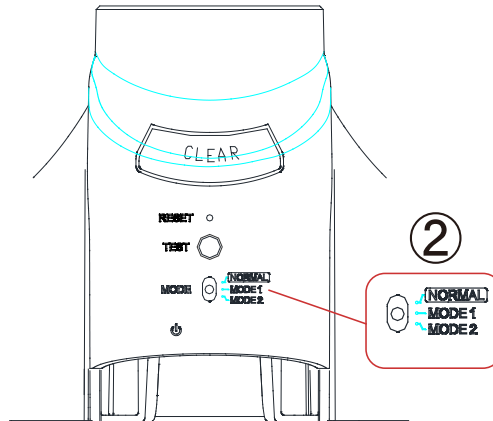

- ③ . After about 50 seconds, the Signal Tower lights up all tiers, with a message, "The Firmware has been updated. Please push the "Test" switch." repeated until the test switch is pushed, so please press the test switch. The Signal Tower flashes pattern 1 while writing is being done.

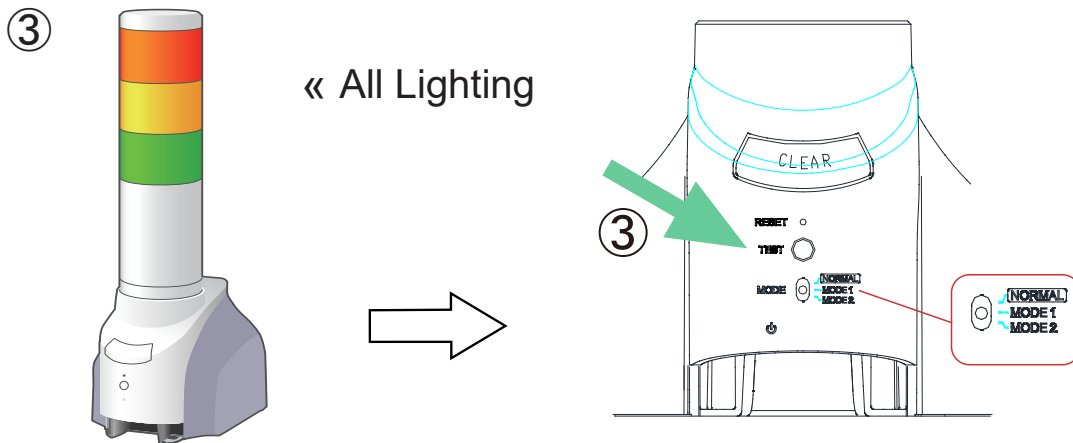

### MEMO

When changing to the mode which can be done when starting up the Main Unit, remove the power source first, then reconnect, or press the reset switch on the front to reboot.



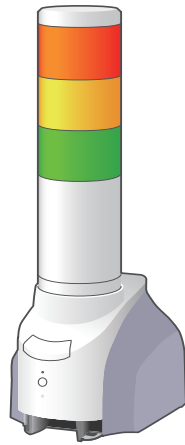

## « Flashing Pattern 1

(Writing Data)



All Lighting  
(Writing Complete)

- ④ . When writing is completed, the Signal Tower lights up all tiers, with a message, "The Firmware update is completed. Return the mode switch to the "NORMAL" position and reboot the Main Unit." repeated until the mode switch is returned to "NORMAL" and the Main Unit is rebooted.  
Set the mode switch to "NORMAL" and extract the USB memory before rebooting the Main Unit.

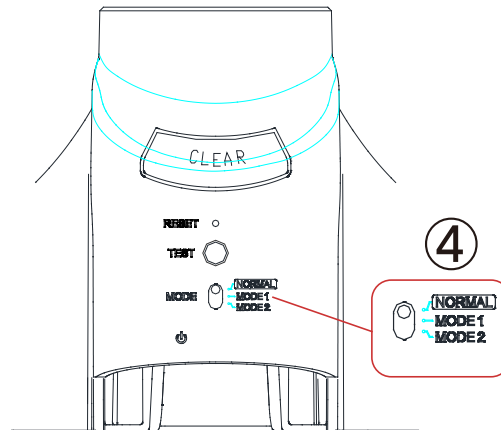

### < When a writing error occurs >

The Signal Tower will flash pattern 2, and repeat playback will sound indicating the contents of the error that occurred. Correct the error in accordance to the contents of the error as indicated below.

- "The USB memory file system is not recognized"  
→ Check whether the format for the SD card is FAT or FAT32.
- "The USB memory does not contain any data"  
→ Save the Playlist Package in the correct folder after referring to "3.21 USB Memory Function".
- "A writing error occurred when storing."  
→ The USB memory and/or playlist data may be corrupted. Save the data in another USB memory and try from step (1) again.

## << Event Log Download Mode >>

- ① . Connect the USB memory.

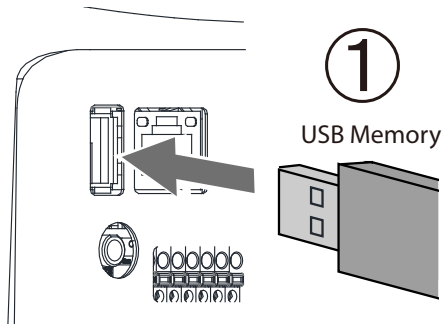

- ② . Set the mode switch to "MODE1" and push the test switch.

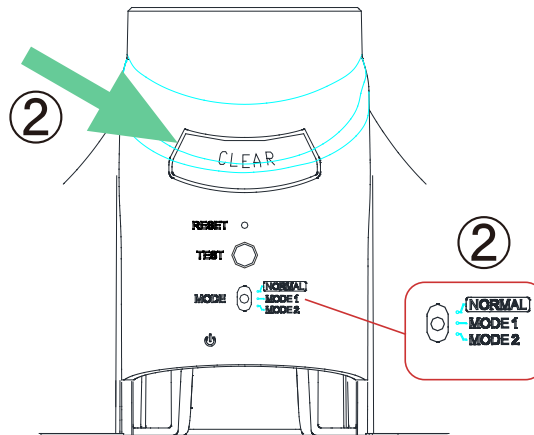

- ③ . The Status LED will flash pattern 1, and the event log is saved to the USB memory.

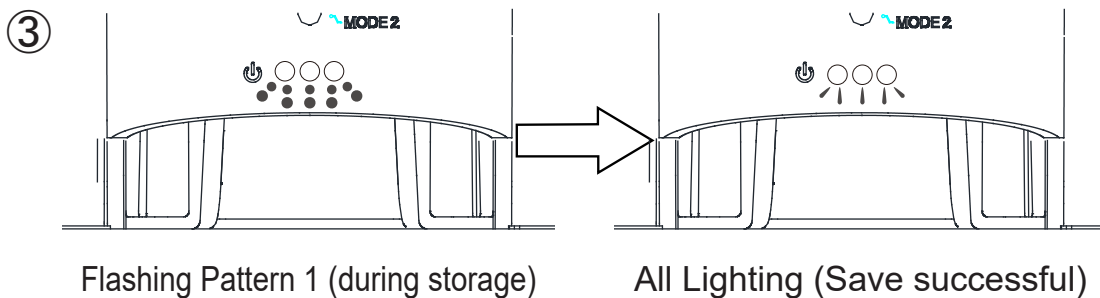

- ④ . If storage is successful in the USB memory, the status LED will light up, with a message, "Storage of the setup information for this machine was saved to the USB memory. Return the mode switch to "NORMAL." repeated. Set the mode switch to "NORMAL" and extract the USB memory before rebooting the Main Unit.

### < When a writing error occurs >

The status LED will flash pattern 2, and repeat playback will sound indicating the contents of the error that occurred. Correct the error in accordance to the contents of the error as indicated below.

- "The USB memory file system is not recognized".  
→ Check whether the format for the SD card is FAT or FAT32.
- "The USB memory does not contain any data".  
→ Save the Playlist Package in the correct folder after referring to "3.21 USB Memory Function".
- "A writing error occurred when storing."  
→ The USB memory and/or playlist data may be corrupted. Save the data in another USB memory and try from step (1) again.

## << Configuration Download Mode >>

- ① . Connect the USB memory.

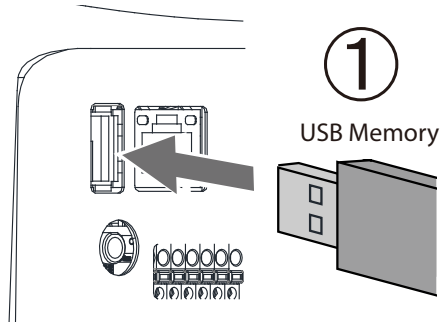

- ② . Set the mode switch to "MODE2" and press the test switch.

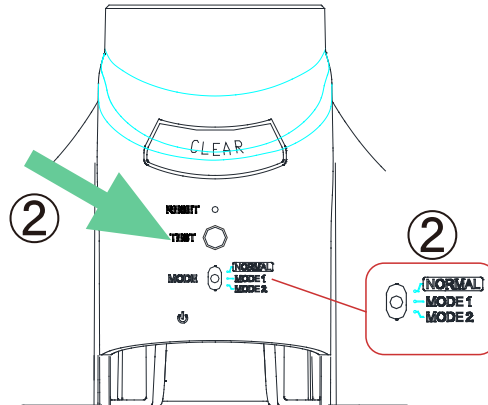

- ③ . Status LED will flash pattern 1, and the configuration data is saved to the USB memory.

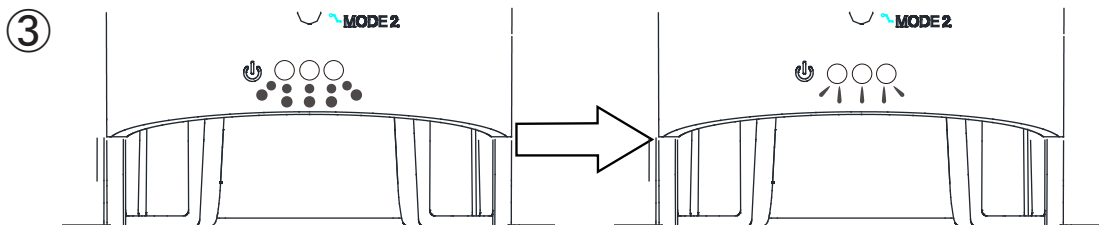
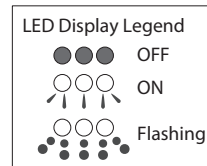

Flashing Pattern 1 (during storage)

All Lighting (Save successful)

- ④ . If storage is successful in the USB memory, the status LED will light up, with a message, "The event log was saved. Return the mode switch to 'NORMAL.'" repeated.

Set the mode switch to "NORMAL" and extract the USB memory before rebooting the Main Unit.

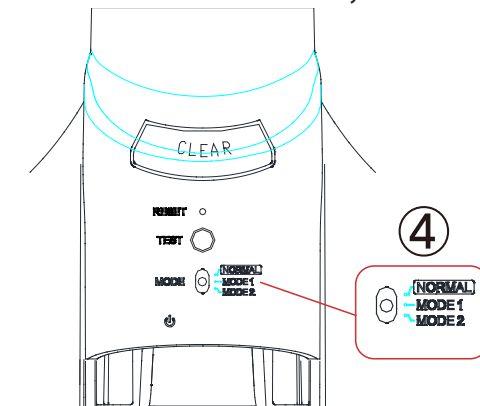

### < When a writing error occurs >

The status LED will flash pattern 2, and repeat playback will sound indicating the contents of the error that occurred. Correct the error in accordance to the contents of the error as indicated below.

- "The USB memory file system is not recognized".  
→ Check whether the format for the SD card is FAT or FAT32.
- "The USB memory does not contain any data".  
→ Save the Playlist Package in the correct folder after referring to "3.21 USB Memory Function".
- "A writing error occurred when storing."  
→ The USB memory and/or playlist data may be corrupted. Save the data in another USB memory and try from step (1) again

## 3.23. Reset Function

Pressing the "Reset Switch" located on the front of this product will execute a power source reset. The switch is located inside the hole of the front panel of this product to prevent any unintentional reset from occurring. Use a wire with the diameter of about 1mm (such as a paper clip), and push it inside the hole to press the internal switch.

### Attention

- Do not exert excessive force when pushing the button. Failure to comply may damage the unit.
- When the reset switch is pressed, it will cause the product to reboot, but all terminal outputs become open during that time. Be careful when resetting the product, only perform this step when it is an unavoidable situation.
- Reset will erase the event log. If the event log is required, be sure to save the log before pressing the reset switch.

## 3.24. Firmware Update Function

The Firmware Update can be done from the Web setup tool, or by the use of the switches on this product. When using the Web setup tool, the firmware can be saved onto the PC etc., and selected to be updated from there. Refer to "4.30 Firmware Update Screen" for details.

When updating the firmware from the USB memory connected to this product, the switch on this product can be used to execute the firmware update. Refer to "3.21 USB Memory Function" and to "3.22 Mode Switch Operating Functions" on pg. 84 for more details.

## 3.25. HTTP Command Control Function

This product can be controlled by transmitting a HTTP command from the HTTP client. In the System Configuration Screen, "Active" or "Inactive" of this function can be set.

[Specification of HTTP command control]

Protocol	HTTP	
Method	GET	
Syntax	http://<IP address>/api/control?<parameter name>=<value>[&<parameter name>=<value>]	
Response	Success.	This message is returned when the control was successful.
	Error. [Error code]	This message is returned when the control was unsuccessful.

Error code	Description
001	Unsupported Method.
002	No such parameter name.
003	Parameter is not specified.
004	Parameter value is not specified.
005	Illegal parameter values.

Parameter	Values	Description
alert=< integer value >	6 digits	Control the Signal Tower LED units and buzzer. Specify the pattern in order of [rybgcz]. r : Red, y : Amber, g : Green, b : Blue, c : White, z : Buzzer. [rygbc] 0 : Off, 1 : On, 2 : Flashing Pattern 1, 3 : Flashing Pattern 2, 9 : No Change [z] 0 : Stop, 1 : Pattern 1, 2 : Pattern 2, 3 : Pattern 3, 4 : Pattern 4, 9 : No Change
clear=< integer value >	1	All digital outputs are turned OFF and change from the monitoring abnormal condition to the monitoring condition. The values (time and number) accumulated in the input condition setting is erased.
output=<integer value>	0, 1, 9	Control the Digital Output. OFF "0", ON "1", no operation "9" are entered.
led=<integer value>	5 digits	Control the Signal Tower LED units. Specify the pattern in order of [rybgc]. r : Red, y : Amber, g : Green, b : Blue, c : White. [rygbc] 0 : Off, 1 : On, 2 : Flashing Pattern 1, 3 : Flashing Pattern 2, 9 : No Change
sound=<integer value>	1 - 70	Playback the MP3 Channnel. Specify the channel to playback. Channnel ( 1 - 70 ).
repeat=<integer value>	1 - 255	A setup for the number of times the "Message Repeat" function plays back for the selected channel. The setup range is "1-255." "255" becomes the same operation as an "endless playback".
stop=<integer value>	1	Stop a Channnel while in playback. The channel is reproduced in cases where there is a channel registered into the channel memory in the time of memory playback mode.

### Attention

- When using the HTTP Command Control function, set "HTTP Command Control Function" to "Active" on System Configuration Screen.
- The parameters that can be specified at the one command are as follows.  
"led"&"sound"  
"sound"&"repeat"  
"led"&"sound"&"repeat"
- Please specify "repeat" and "sound" with one command.

### 3.25.1. Example

<alert>

Red : on, Amber : off, Green : on, Blue : off, White : off, Buzzer : Pattern 2 on.

<http://192.168.10.1/api/control?alert=101002>

Red : on, Amber : flashing pattern 1, Green, Blue and White : No Change, Buzzer : Pattern 3 on.

<http://192.168.10.1/api/control?alert=129993>

<clear>

Turn off all the Signal Tower Lights and stop the Buzzer and change from the monitoring abnormal condition to the monitoring condition.

<http://192.168.10.1/api/control?clear=1>

<output>

Digital Output : ON.

<http://192.168.10.1/api/control?output=1>

<led>

Red and Amber : flashing pattern 1, Green and Blue : flashing pattern 2, White : on.

<http://192.168.10.1/api/control?led=22331>

<sound>

Play back channel 10.

<http://192.168.10.1/api/control?sound=10>

<repeat and sound>

Play back channel 1 continuously.

<http://192.168.10.1/api/control?repeat=255&sound=1>

<stop>

Stop a Channel / Sending music (when memory playback mode is selected).

<http://192.168.10.1/api/control?stop=1>

<led and sound>

Red : on, Amber : flashing pattern 1, Green : flashing pattern 2, Blue : No Change, White : off, Sound: play back channel 5.

<http://192.168.10.1/api/control?led=12390&sound=5>

<led, sound and repeat>

Red : on, Amber : off, Green : on, Blue : off, White : off, Sound: repeat play back channel 12 seven times.

<http://192.168.10.1/api/control?led=10100&sound=12&repeat=6>

## 3.26. Scheduling Function

You can make a schedule to register the day of the week and the time-frame when the system is not in operation, such as the LED lighting and sound reproduction.

Time periods, such as nighttime and holidays, where notifications aren't necessary, can be set up.

### [Time range Setup]

The time range can be designated up to three times in one day.

Specific example	Time range 1	00 hours 00 minutes to 8 hours 30 minutes
	Time Range 2	11 hours 30 minutes to 13 hours 15 minutes
	Time Range 3	17 hours 45 minutes to 24 hours 00 minutes

### [Scheduling Function Setup]

For each day of the week, set the time period for disabling the notification operation by enabling the 24-hour schedule function or to stop the notification operation only for the specified time period.

#### Active Scheduling Period

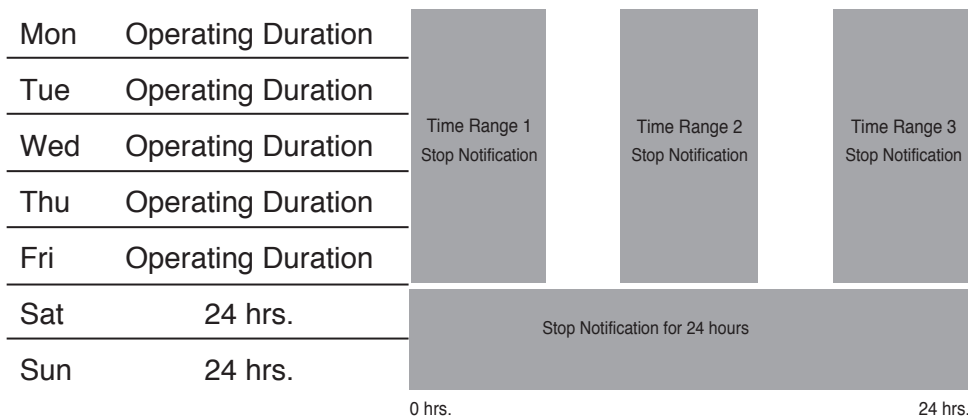

Suspended operations during activated scheduling	Reference
"Signal Tower", "Sound and Buzzer" and "Digital Output" control, due to the RSH command	3.10 RSH Command Function
"Signal Tower", "Sound and Buzzer" and "Digital Output" control, due to the PNS Command	3.8 PNS Command Reception Function
"Signal Tower", "Sound and Buzzer" control, due to the PHN Command	3.7 PNS Command Reception Function
"Signal Tower", "Sound and Buzzer" and "Digital Output" control, due to the HTTP Command	3.25. HTTP command control function
"Signal Tower", "Sound and Buzzer" and "Digital Output" control, due to the SNMP Command	3.5.1 SNMP SET Control Function of Signal Tower Channel Playback
"Signal Tower", "Sound and Buzzer" and "Digital Output" control, due to the Operation Event	3.2.2 Digital Input Monitoring Function 3.6. SNMP Compatible Equipment Monitor Function 3.11. Ping Monitoring Function 3.12. Application Monitoring Function 3.13. SLMP Read Command Transmission Function 3.16 Digital Input Condition Setup Function
TRAP Transmission	3.5.4. TRAP Transmission Function

Active Operations during enabled schedule	Reference
"Clear" Execution	3.15. "Clear" operation function
E-mail Transmission	3.9. Mail Transmission Function
Test Switch	3.4. Test Function
Web Setup Tool	4. Function Setup
SLMP write command transmission	3.14 SLMP Write Command Transmission Function
Event log output	3.19 Event Log Output Function
Audio suspension	3.1.7. Playback Mode
Various operations due to mode switching functions	3.21 Mode Switching Functions

**MEMO**

- ◆ When using the schedule function, be sure to use it with the NTP.  
(Refer to "2.9.1. Clock Settings")
- ◆ While the schedule function is active, the status LED on the front of the unit blinks with blinking pattern 1.
- ◆ When operating with the mode switching function, the guidance voice is played, even while the schedule function is active.



# 4. Function Setup

The function setup is available in order to take advantage of the various functions. To access the settings, click the setup items on the left-hand side of the Web Setup Tool to open the set up screen for the various functions.

Table 4.0.0–1 Function List

Setup Category	Setup Screen	Setup Contents
Setup Menu	System Configuration	Sets up the network configuration.
	Clock Settings	Sets up the time for this product.
	User Authorization Configuration	Sets up the login password for this product.
	SNMP Configuration	Sets up the transmission function or transmission destination address community name for the TRAP SNMP SET/GET functions.
	Socket Transmission Configuration	Sets up the ports to receive the PHN and PNS Commands.
	E-mail Settings	Sets up the e-mail transmissions for this product.
	E-Mail Message Settings	Setup for writing the message contents to be transmitted by E-mail.
	RSH Command Configuration	Sets up the RSH command for receiving.
	Relay Contact Output Setup	Sets up the output terminals for the logic applications.
	Sound Channel Setup	Registration for voice data, title, and can play back sample sounds.
	Schedule Function Settings	Set up a schedule to halt during weekends and holidays, etc.
Operation Settings	Digital Input Setup	Each digital input can be set up.
	TRAP Reception Configuration	The setup which controls the status condition when a TRAP or TRAP reception is received.
	Ping Monitoring Configuration	The setup of the address for the monitored equipment and the management when an abnormality and abnormality recovery is detected.
	Application Monitoring Configuration	The setup of the address for the monitored equipment and the management when an abnormality and abnormality recovery is detected.
	“Clear” Control Configuration	Set up for operation when executing a “Clear” command or pressing the “Clear” switch.
	Normal Mode Settings	Set up to turn ON a specific LED color on the Signal Tower.
	Test Switch Settings	Set up an operation when the test switch is pushed.
	SLMP Read Command Configuration	Sets up the condition agreement to operate when an error occurs from the device information on the equipment that corresponds to the SLMP protocol.
	SLMP Write Command Configuration	Sets up the write command contents when transmitting to the equipment that corresponds to the SLMP protocol.
	SNMP Supported equipment monitor - Condition Agreement Detection	Set up of the OID used for the monitoring object equipment address to set up operation conditions for the condition agreement and condition release.
	SNMP supported equipment monitor - Change Detection	The address of monitoring object equipment and the operation at the time of OID which monitors change, and a change detection are set up.
Digital Input Condition Settings	Set up for the digital input conditions and the operation when condition agreements occur.	
NH Unit Controls	Signal Tower Output Control	Controls the Signal Tower.
	Reinitialization	The settings return to factory default values.
	Reboot	Reboots this product after settings have been changed to put them into effect.
Maintenance Functions	Event Log	The event log can be displayed and downloaded.
	XML Settings	The XML data output is set up.
	Configuration Data Settings	Set up to save the configuration data items and be reloaded at any time.
	Firmware Update	The Firmware can be updated with this function.
	Setup Table Entries	Set up to display the list of items and their operation contents setup.

**Attention**

After completing the desired setup configuration, reboot this product by pressing the “reset” button, or removing the power for a few seconds and reapplying it for the changes to take effect.

## 4.1. System Configuration Screen

The system setup can be done on this product. The default IP address is "192.168.10.1". The parameters can be setup from the System Setup Screen ("Figure 4.1.0-1") from the default values as shown in "Table 4.1.0-1".

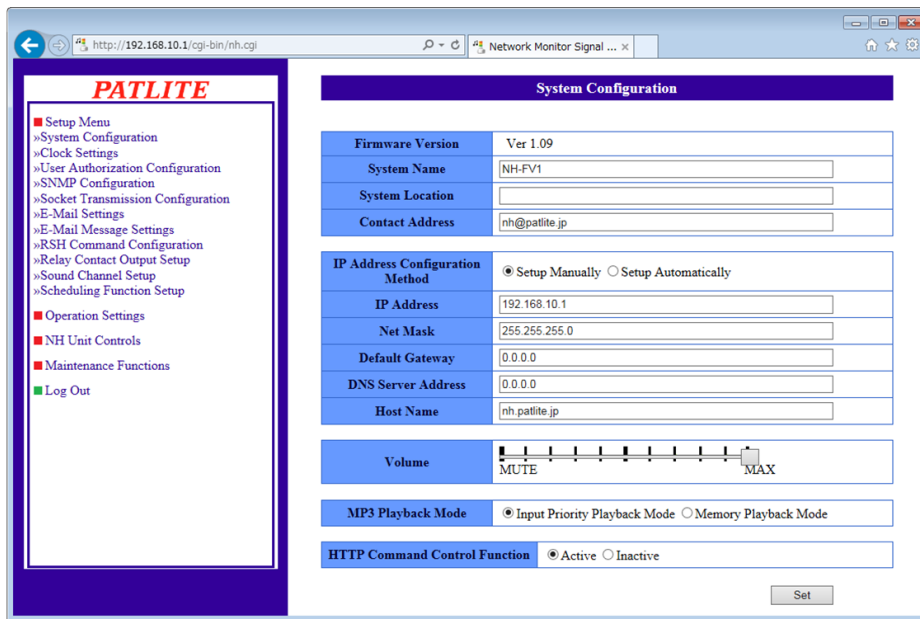

Figure 4.1.0-1 System Setup Screen

Table 4.1.0-1 System Setup Parameters

Item	Contents	Default Value	Input Parameter	Setup Option
Firmware Version	The firmware version is displayed on this product.	*	*	×
System Name	An arbitrary name for this product can be entered.	NH-FV1	Full/Half width Char. Max. 31 Character	○
System Location	The setup location of this product can be entered.	Blank	Half-width alphanumeric character and "_". Max. 31 Character	○
Contact Address	Enter a contact address.	nh@patlite.jp	Mail address form Max. 63 Character	○
IP Address Configuration Method	Select the method for setting up the IP address as "Setup Manually" or "Setup Automatically".	Manual	*	×
IP Address	Enter the IP address of this product.	192.168.10.1	IP Address Format	×
Net Mask	Enter the subnet mask of this product.	255.255.255.0	IP Address Format	×
Default Gateway	Enter the default gateway of this product.	0.0.0.0	IP Address Format	○
DNS Server Address	Enter the DNS Server configurations.	0.0.0.0	IP Address Format	○
Host Name	Enter the host name.	nh.patlite.jp	Host name max. 62 Character	×
Volume	Set up the sound volume of this product.	MAX	*	×
MP3 Playback Mode	Set up the Channel Playback Mode method.	Input Priority Playback Mode	*	×
HTTP Command Control Function	Select "Active" or "Inactive" for the HTTP Command Control Function.	Active	*	*

\* The "Setup Option" indication is explained below to indicate in the diagram whether a value input is omissible (a blank is used) or not.

The "O" indicates where it is omissible.

The "x" indicates where is not omissible, or is selected from an item menu.

### Attention

- The sound volume set up is the same for both the Main Unit loudspeaker and Lineout.
- The volume for the Main Unit loudspeaker is on the side of the body, and can be adjusted after setting up the sound reduction for the master volume.

## 4.2. Clock Settings Screen

The clock setup for this product can be done through a browser. The parameter set up on a time setting screen is a diagram. It is a passage of 4.2.1.

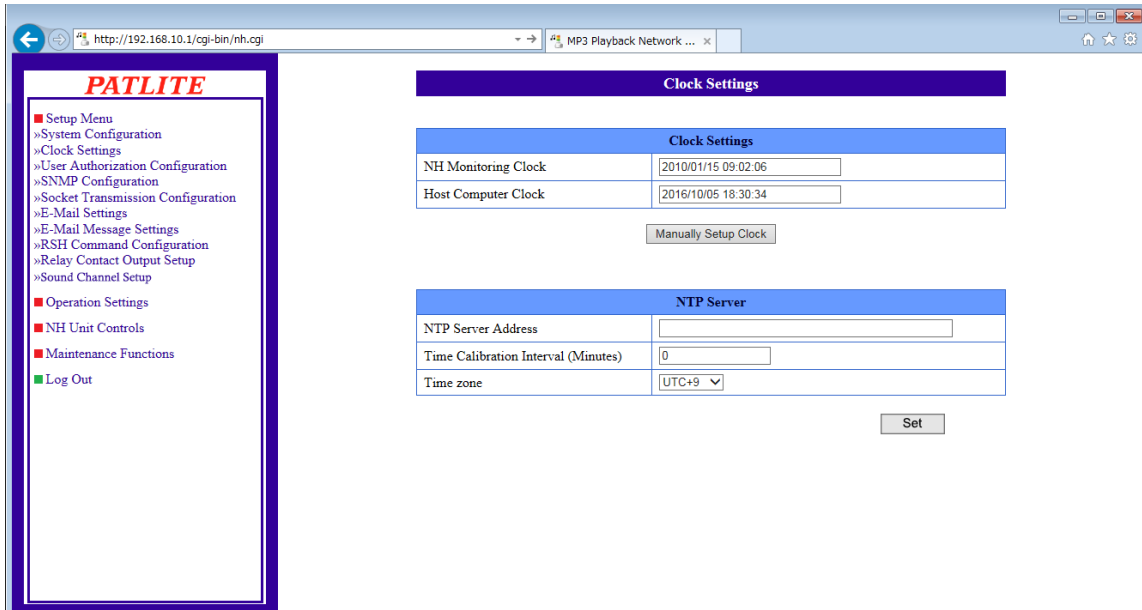

Figure 4.2.0–1 Clock Settings Screen

Table 4.2.0–1 Clock Settings Parameters

Item	Contents	Default Value	Input Parameter	Setup Option
NH Monitoring Clock	The time is displayed on this product.	*	*	×
Host Computer Clock	The time on the PC logged in to this product is displayed.	*	*	×
NTP Server Address	Enter the NTP server address.	Blank	A host name or IP address Max.: 63 Characters	○
Time Calibration Interval	A time interval to communicate with the NTP server can be entered. If the value is set at '0', this product does not communicate with an NTP server.	0	Half-width numbers from 0-1440 (minutes)	○

Two kind of clock setup methods are indicated below:

- Communicates with the PC clock to adjust the time when logging in.
- Communicates with an NTP server and the time of this product is rectified.

**Attention**

- A login time-out will occur if the equipment has been sitting untouched for 10 minutes or more. Re-enter the password again from the login screen.

\* The "Setup Option" indication is explained below to indicate in the diagram whether a value input is omissible (a blank is used) or not.

The "O" indicates where it is omissible.

The "x" indicates where is not omissible, or is selected from an item menu.

## 4.2.1. PC Clock Synchronization

The PC clock time is reflected in this product when logged in again.

### [Setup Method]

- ① . Compare the columns between the “NH Monitor Time” and the “Host Computer Time.”
- ② . Click the “Manually Setup Clock” button to synchronize the time with the PC which is logged in.

### Attention

- In some cases, this product may not reflect the exact time as the PC, and the clock may be off by several seconds.
- When not using an NTP server, check the time of this product periodically.
- This product uses a capacitor as a battery backup for the time stamp. Depending on the charge status of the capacitor, it may last from about 2 to 3 days and if the power supply is not applied during the day, a gap in time or the need to reset the time may be necessary. If an application environment requires a time entry, be sure to set up the time before the application.
- If the backup is depleted and the time entry resets, the set time will be labeled as “Jan 1, 2010.”

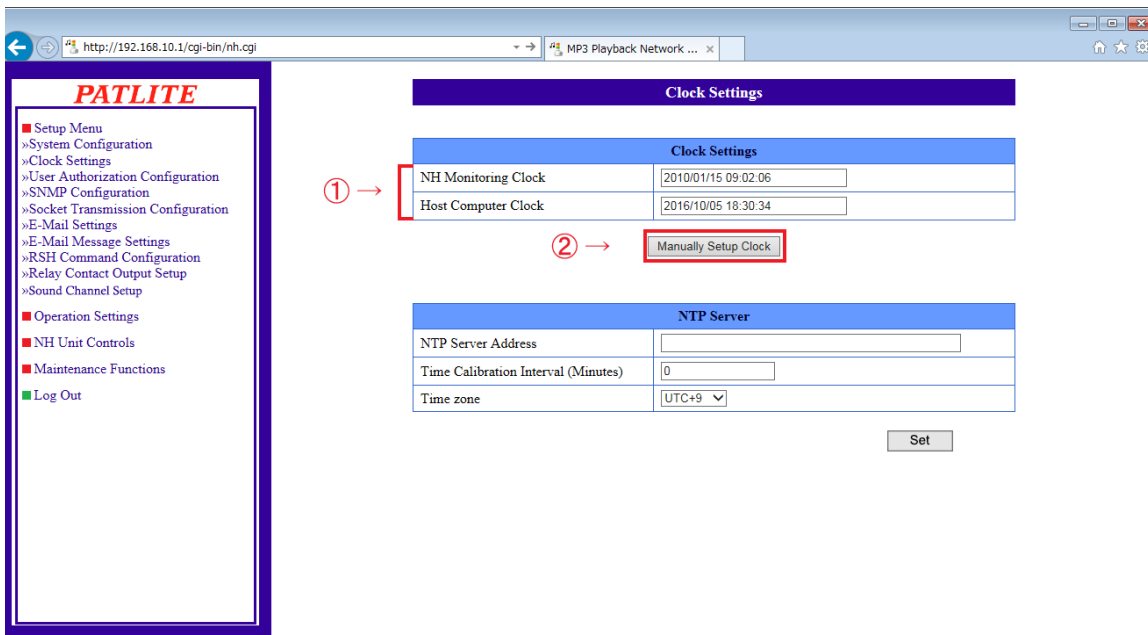

Figure 4.2.1–1 Setup Screen before “Manually Setup Clock” button is clicked

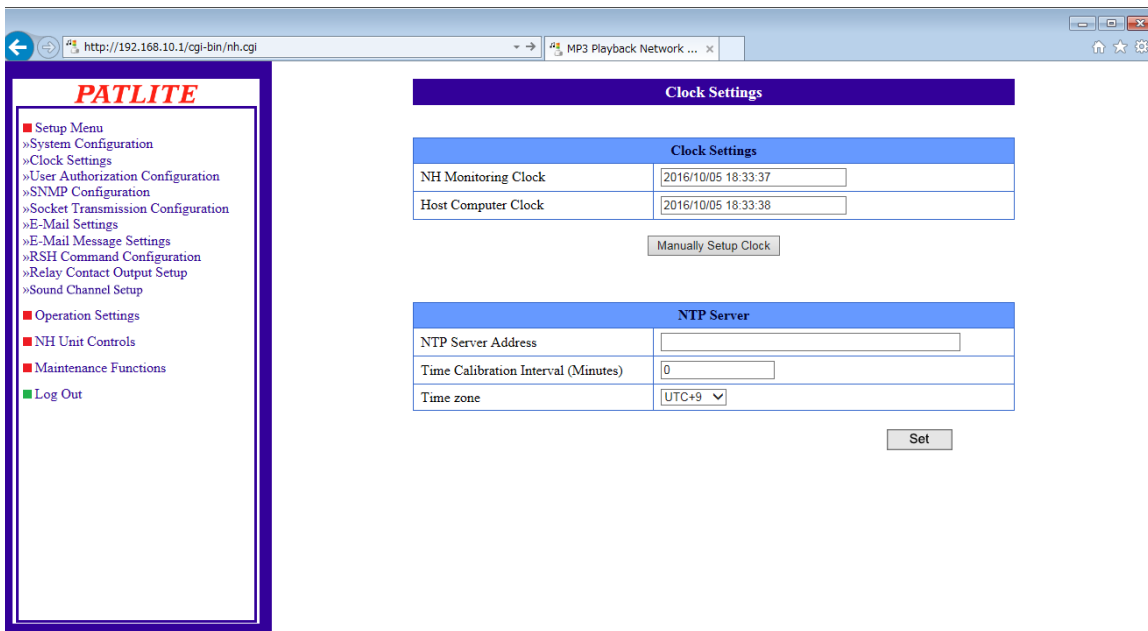

Figure 4.2.1–2 Setup Screen after “Manually Setup Clock” button is clicked

## 4.2.2. Synchronizing with an NTP server

An NTP server can be linked by entering the NTP server address to synchronize with the clock in this product.

### [Setup Method]

- ① Enter the NTP server address in the “NTP Server Address” column.
- ② Enter in the “Time Calibration Interval” column, the interval (0 to 1440 minutes) to connect with an NTP server.
- ③ Click the “Set” button to activate the setup.

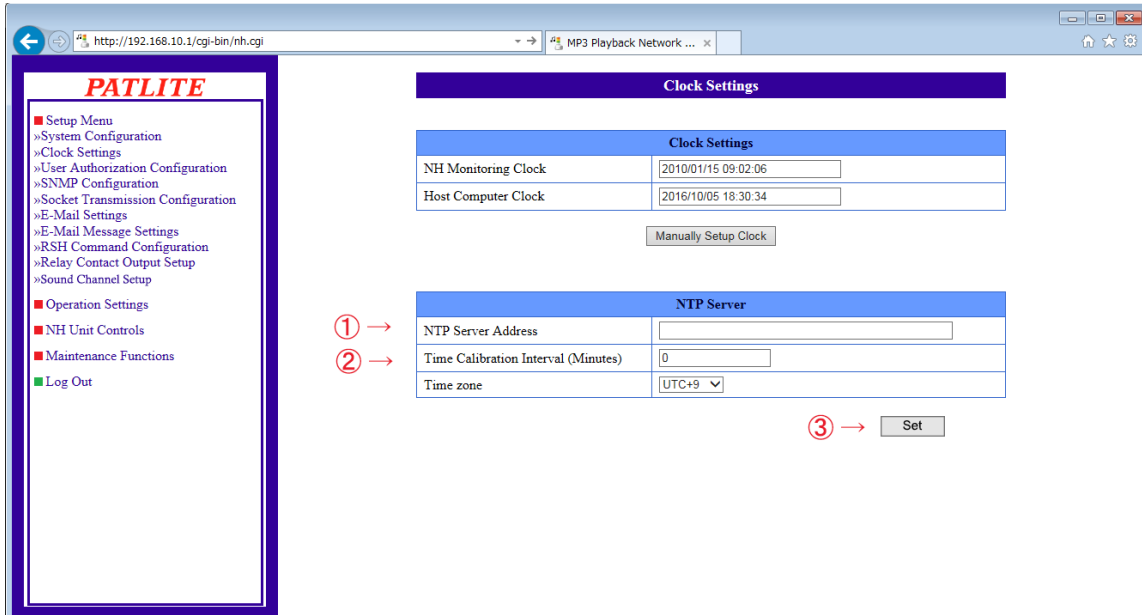

Figure 4.2.2–1 Clock Settings Screen for an NTP Server

### Attention

- Be sure to connect with an NTP server before setting up and confirm that the time entry is acquirable.
- If “0” is entered in the time correction delay, the communication between the NTP server will not occur.

## 4.2.3. Setting the Time zone

Determine the area to be used when setting the time zone.

### [Setup Method]

- ① Select from the “Time Zone” column and click to set.
- ② Click the “Set” button to activate the setup.

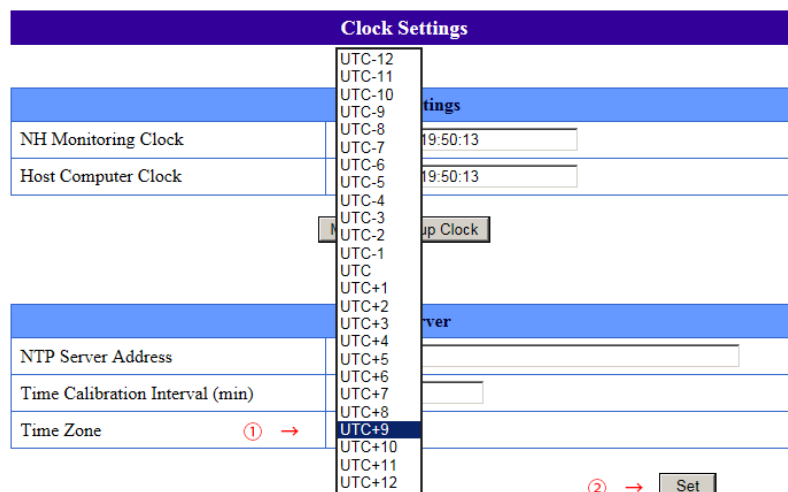

## 4.3. User Authentication Configuration Screen

Setup a password to log into the Setup Screen for this product.

The next time for logging in will ask for the new password. The set up password to be used can be up to 16 half-width alphanumeric characters and a "." (period). The parameters can be set up from the user authentication screen as shown in "Table 4.3.0-1".

### [Setup Method]

- ① . Enter a new password into the "password" column.
- ② . Enter the new password into the "Re-enter Password" column once again.
- ③ . Click the "Set" button to activate the setup.

Log in with the new password the next time a login screen appears.

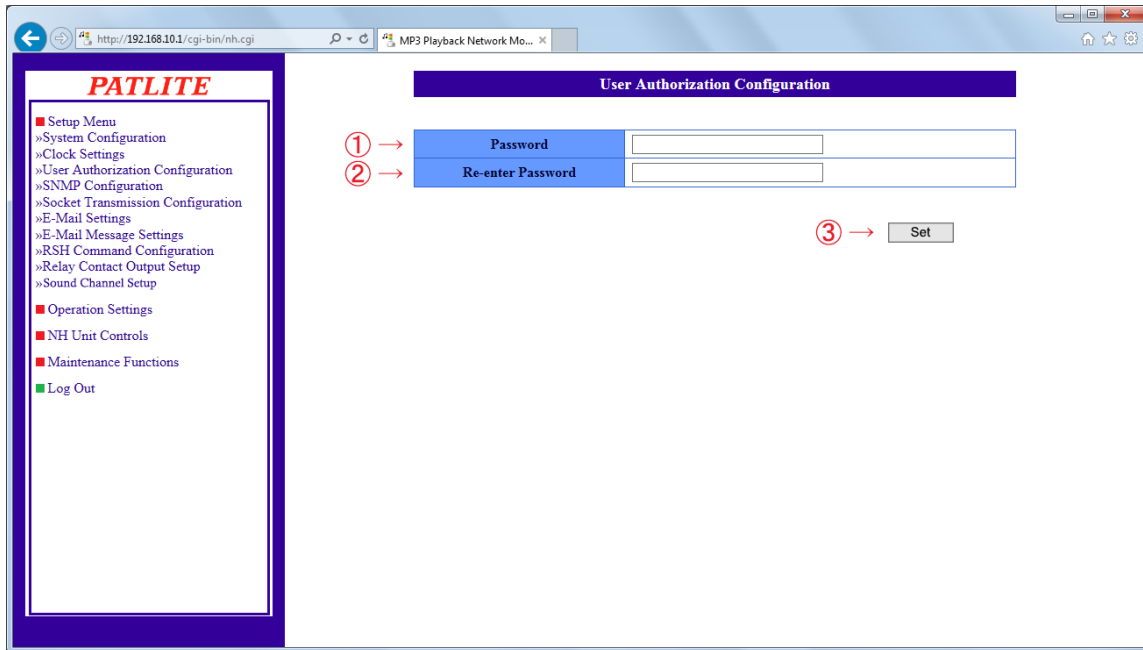

Figure 4.3.0-1 User Authentication Configuration Screen

Table 4.3.0-1 User Authentication Configuration Parameters

Item	Contents	Default Value	Input Parameter	Setup Option
Password	Enter a new password.	Blank	half-width alphanumeric character and "."(Period) Max.: 16 characters	x
Re-enter Password	RE-enter the new password. (For confirmation)	Blank	half-width alphanumeric character and "."(Period) Max.: 16 characters	x

\* The "Setup Option" indication is explained below to indicate in the diagram whether a value input is omissible (a blank is used) or not.

The "x" indicates where is not omissible, or is selected from an item menu.

## 4.4. SNMP Configuration Screen

With an SNMP, this product can communicate outside the community name for the notification of a TRAP, using the SNMP SET/GET in reference to each item for this product, and generate the event with this product. The parameters in "Table 4.4.0-1 SNMP Configuration Parameters" can be set up for the SNMP Setup Screen.

### 4.4.1. SNMP Command Transmit and Receive

An SNMP SET/GET can be setup.

#### [Setup Method]

1. Select the "Active" radio button to enable the "SNMP Command Reception function".
2. Enter a "SET/GET community".

### 4.4.2. SNMP Supported Equipment Monitor

An SNMP Supported equipment monitor function can be set up.

#### [Setup Method]

3. When the equipment monitor function corresponding to SNMP is enabled, select "Active".
4. Enter the "GET community".

### 4.4.3. SNMP TRAP Reception

An SNMP TRAP reception can be set up.

#### [Setup Method]

5. A "TRAP Reception Community" is entered.

### 4.4.4. SNMP TRAP Transmission

An SNMP TRAP Transmission can be setup.

#### [Setup Method]

6. Select the "Active" radio button to enable the "TRAP Transmission Function".
7. Enter the "TRAP Transmission community" and "Number of Trap Transmissions".
8. Enter in the "TRAP Receiver Address" column the IP address for sending the TRAP notification to.
9. Click the "Set" button to activate the setup.

The screenshot shows the PATLITE SNMP Configuration screen. The browser address bar shows <http://192.168.10.1/cgi-bin/nh.cgi>. The page title is "SNMP Configuration".

**SNMP Command Reception**

SNMP Command Reception Function	<input checked="" type="radio"/> Active <input type="radio"/> Inactive
SET Community	private
GET Community	public

**SNMP Supported Equipment Monitor**

SNMP Supported Equipment Monitor Function	<input checked="" type="radio"/> Active <input type="radio"/> Inactive
GET Community	public

**TRAP Reception**

TRAP Reception Community	public
--------------------------	--------

**TRAP Transmission**

TRAP Transmission Function	<input type="radio"/> Active <input checked="" type="radio"/> Inactive
TRAP Transmission Community	public
Number of Trap Transmissions	1

**TRAP Receiver Address**

1	
2	
3	
4	
5	
6	
7	
8	

At the bottom right, there is a "Set" button.

Figure 4.4.4-1 SNMP Configuration Screen

Table 4.4.0-1 SNMP Configuration Parameters

Item	Contents	Default Value	Input Parameter	Setup Option
SNMP Command Reception Function	Select "Active" or "Inactive" for the SNMP command reception function.	Active	*	×
SET Community	The name entered when reading an SNMP set up value.	private	Half-width alphanumeric character and "_". Max. 32 Character	×
GET Community	The name entered when writing an SNMP set up value.	public	Half-width alphanumeric character and "_". Max. 32 Character	×
SNMP Supported Equipment Monitor Function	Select "Active" or "Inactive" for the SNMP Supported Equipment Monitor Function.	Active	*	×
SNMP Monitoring Function GET Community	The name entered when writing an SNMP monitoring function set up value.	public	Half-width alphanumeric character and "_". Max. 32 Character	×
TRAP Reception Community	Enter the receiving TRAP community name.	public	Half-width alphanumeric character and "_". Max. 32 Character	×
TRAP Transmission Function	Select "Active" or "Inactive" for the TRAP Transmission Function	Inactive	*	×
TRAP Transmission Community	Enter the transmitting TRAP community name.	public	Half-width alphanumeric character and "_". Max. 32 Character	×
Number of Trap Transmissions	Enter how many times the same TRAP is transmitted when transmitting the TRAP.	1	1-10	×
TRAP Receiver Address	Enter the transmitting address for the designated TRAP sender.	Blank	A host name or the IP address formal host name. Max.: 63 Characters	○

\* The "Setup Option" indication is explained below to indicate in the diagram whether a value input is omissible (a blank is used) or not.

The "O" indicates where it is omissible.

The "x" indicates where is not omissible, or is selected from an item menu.



## 4.5. Socket Transmission Configuration Screen

Set up the Socket Transmission ports to control the PHN Command and PNS Command outputs.

### [Setup Method]

- ① Select either "TCP" or "UDP" in the "protocol" field for the communication method.
- ② Enter the port to be used in the "Port Number" field.
- ③ Click the "Set" button to activate the setup.

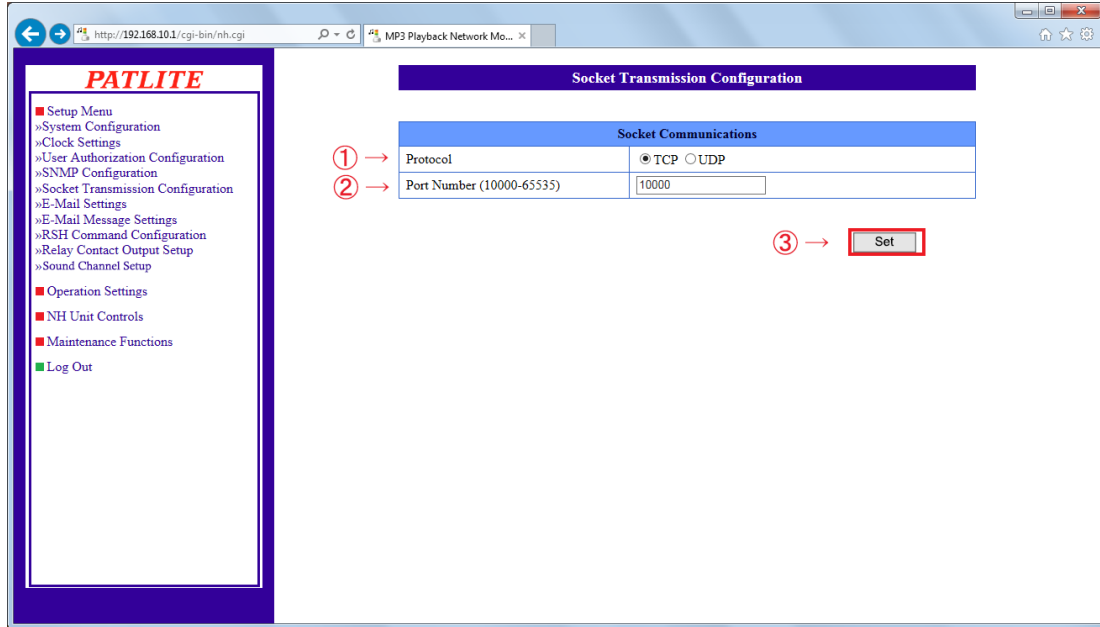

Figure 4.5.0-1 Socket Communication Configuration Screen

Table 4.5.0-1 Socket Communication Configuration Parameters

Item	Contents	Default Value	Input Parameter	Setup Option
Protocol	Select "TCP" or "UDP" for the protocol	TCP	*	×
Port Number	Enter the receiving port number.	10000	Half-width digits: 10000-65535	×

#### MEMO

Refer to "3.7 PHN Command Reception Function" for PHN Command details.  
Refer to "3.8 PNS Command Reception Function" for PNS Command details.

\* The "Setup Option" indication is explained below to indicate in the diagram whether a value input is omissible (a blank is used) or not.

The "x" indicates where is not omissible, or is selected from an item menu.

## 4.6. E-Mail Settings Screen

This product can be set up to send E-mail messages. The following are events which will transmit E-mail messages. When transmitting an E-mail, it is transmitted in sequence from the smaller address number to the larger address number of the addressee. The parameters in "Table 4.6.0-1 E-mail Settings Parameters" can be set up in the e-mail contents setup screen.

### << E-mail Transmitting Event >>

- E-mail Transmitting Event
- Received TRAP
- At the time of a Ping monitoring abnormality/recovery event.
- At the time of an application monitoring abnormality/recovery event.
- At the time when the "CLEAR" button is pressed.
- "Clear" operation run time
- When the digital input condition agrees
- When an SLMP monitor condition agreement/error reception occurs
- When an SNMP equipment monitor condition agreement/condition cancellation occurs.
- RSH command runtime
- When the "TEST" button is pressed

#### [Setup Method]

1. Enter an SMTP mail server address port number.
2. Enter the account name and SMTP authentication password when using the SMTP authentication.
3. When making an encryption connection, select either "SSL" or "TLS".
4. When using POP authentication, enter the POP server address, POP port number, POP account name, and POP authentication password.
5. "No Authentication" is selected when authentication is not necessary.
6. Enter the e-mail address for the designated sender.
7. Enter the transmission destination address.
8. Click the "Set" button to activate the setup.

The screenshot shows the 'E-Mail Settings' screen with the following components:

- Navigation Menu (Left):** Includes Setup Menu, System Configuration, Clock Settings, User Authorization Configuration, SNMP Configuration, Socket Transmission Configuration, E-Mail Settings (highlighted), E-Mail Message Settings, RSH Command Configuration, Relay Contact Output Setup, Sound Channel Setup, Operation Settings, NH Unit Controls, Maintenance Functions, and Log Out.
- Server Configuration:**
  - SMTP Server Address: [Text Field]
  - SMTP Port Number: [25]
  - Method:
    - SMTP Authentication: Encrypted Connection (SSL, TLS, None), SMTP Account Name, SMTP Authentication Password.
    - POP Authentication: POP Server Address, POP Port Number (110), POP Account Name, POP Authentication Password.
    - No Authentication
- Transmission Settings:**
  - Source Address: [Text Field]
  - Address of Receiver: Table with 8 rows and 2 columns (ID, Address).
- Buttons:** A 'Set' button is located at the bottom right.

Figure 4.6.0-1 E-Mail Settings Screen

Table 4.6.0–1 E-mail Settings Parameters

Item	Contents	Default Value	Input Parameter	Setup Option
SMTP Server Address	Enter the SMTP server address.	Blank	Characters used for a server address; Maximum 63 Characters	×
SMTP Port Number	Enter the SMTP server port number.	25	Half-width numbers from 1-65535	×
Method	Select among: "SMTP Authentication"/"POP Authentication"/"No Authentication".	No Authentication	*	×
Encrypted Connection	Select among "SSL"/"TLS"/"None"	None	*	×
SMTP Account Name	Enter the account name for the SMTP authentication.	Blank	Characters used for a mail address; Maximum 32 Characters	×
SMTP Authentication Password	Enter the password for SMTP authentication.	Blank	Half-width alphanumeric characters; Maximum 32 Characters	×
POP3 Server Address	Enter the POP3 server address.	Blank	Characters used for a server address; Maximum 63 Characters	×
POP3 Port Number	Enter the port number for the POP3 server.	110	Half-width digits 1-65535	×
POP Account Name	Enter the account name for the POP authentication.	Blank	Characters used for a mail address; Maximum 32 Characters	×
POP Authentication Password	Enter the password for POP Authentication.	Blank	Half-width alphanumeric characters; Maximum 32 Characters	×
Source Address	Enter the e-mail address for the designated sender.	Blank	Characters used for a mail address; Maximum 63 Characters	○
Receiver Address 1-8	Enter the e-mail address for the Transmission destination addresses.	Blank	Characters used for a mail address; Maximum 63 Characters	○

\* The "Setup Option" indication is explained below to indicate in the diagram whether a value input is omissible (a blank is used) or not.

The "O" indicates where it is omissible.

The "x" indicates where is not omissible, or is selected from an item menu.

## 4.7. E-Mail Message Settings Screen

The following is the setup of E-mail titles and message contents for E-mail Sending. When sending E-mails, the contents can be personalized to match the coinciding mail notifications by entering a title and message contents to transmit. The items in "Table 4.7.0-1 E-mail Message Settings Parameters" can be set up in the e-mail contents setup screen.

### [Setup Method]

- ① Enter a title in the subject field to transmit by e-mail. (Full or half alphanumeric characters of up to 32 characters)
- ② Enter text to transmit for e-mail. (Full or half alphanumeric characters of up to 63 characters)
- ③ Click the "Set" button to activate the setup.

### Attention

When using full width characters for a subject, use JIS level-1 kanji (except for special characters).  
When transmitting mail, a character may transform itself when received.

Figure 4.7.0-1 E-mail Message Settings Contents

Table 4.7.0-1 E-mail Message Settings Parameters

Item	Contents	Default Value	Input Parameter	Setup Option
Subjects 1-16	Enter the subjects from 1-16.	Message from Signal Tower	Full or half size Maximum: 32 Characters	○
Messages 1-16	Enter the messages from 1-16.	Blank	Full or half size Maximum: 63 Characters	○

\* The "Setup Option" indication is explained below to indicate in the diagram whether a value input is omissible (a blank is used) or not.

The "O" indicates where it is omissible.

## 4.8. RSH Command Configuration Screen

Sets up the RSH command for receiving.

### [Setup Method]

- ① Select among "Active"/"Inactive" for the "RSH Server Function."
- ② Select among "public"/"private" for the "RSH alert timer reset function."
- ③ Select the E-mail Sending set up for RSH command reception mail.  
If the E-mail Sending is made "Active", the "E-mail Addressee" is selected for "subject" and "text" after activation.
- ④ Select "Active" if the TRAP transmission is used with the RSH command reception mail.

< The "TRAP Command" for this product to receive when the TRAP condition occurs >

OID [1.3.6.1.4.1.20440.4.1.6.5

Name: [trapPatliteRshExecuted]

- ⑤ If address restrictions for the RSH command designated sender are made, set the "Designated Sender Address" to "Active".  
"Inactive" is used when address restrictions are not done.
- ⑥ If the "Designated Sender Address" is made "Inactive", enter the public account after the designated sender address is invalidated.
- ⑦ Enter the IP address into the designated sender IP address column to allow command execution. (Maximum of 16 Addresses)  
Enter the account which permits a command execution account.
- ⑧ Click the "Set" button to activate the setup.

The screenshot shows the 'RSH Command Configuration' web interface. On the left is a navigation menu for 'PATLITE' with options like 'Setup Menu', 'System Configuration', 'User Authorization Configuration', etc. The main content area is titled 'RSH Command Configuration' and contains the following sections:

- RSH Server:**
  - RSH Server Function:  Active  Inactive
  - RSH Alert Timer Restoration Function:  Shared  Individual
  - E-mail Transmission:  Active  Inactive Subject [1.Message] Message [1: ]
  - E-mail Receiver: 1 Unassigned, 2 Unassigned, 3 Unassigned, 4 Unassigned, 5 Unassigned, 6 Unassigned, 7 Unassigned, 8 Unassigned
  - TRAP Transmission:  Active  Inactive
- Connection Authorization Configuration:**
  - Designated Sender Address:  Active  Inactive
  - Common login name when designated sender address is inactive: [ ]
- Designated Sender Address Table:**

Sender IP Address	Login Name
1	[ ]
2	[ ]
3	[ ]
4	[ ]
5	[ ]
6	[ ]
7	[ ]
8	[ ]
9	[ ]
10	[ ]
11	[ ]
12	[ ]
13	[ ]
14	[ ]
15	[ ]
16	[ ]

At the bottom right, there is a 'Set' button. Red circles with arrows (①-⑧) point to the corresponding configuration elements described in the text above.

Figure 4.8.0-1 RSH Command Configuration Screen

Table 4.8.0–1 RSH Command Configuration Parameters

Item	Contents	Default Value	Input Parameter	Setup Option
RSH Server Function	Select among “effective”/”Inactive” for the “RSH Server Function”	Active	*	×
RSH Alert Timer Restoration Function	A timer set for “Public”/”Private” can be implemented to control the operating timing of each tier and the buzzer with an RSH command sent to the Signal Tower.	Shared	*	×
E-mail Transmission	Select Active/Inactive for sending an E-mail when a command is received.	Inactive	*	×
Subject	Select the subject title for the mail to be transmitted.	1.Message	*	×
Message	Select the message text for the mail to be transmitted.	1:	*	×
E-mail Receiver	Select the recipient to send E-mail to.	Unassigned	*	×
TRAP Transmission	Select Active/Inactive for the TRAP transmission when an RSH Command is received.	Inactive	*	×
Designated Sender Address	Select between “Active”/”Inactive” for command designated sender address restrictions.	Active	*	×
Common login name	When the designated sender addressing is inactive, enter the login name used.	Blank	Half-width alphanumeric character, period “.”, hyphen “-”; Max.: 16 Characters	○
Sender IP Address	Enter the authorized IP address for command execution.	Blank	IP Address Format	○
Login Name	Enter the authorized login name for command execution.	Blank	Half-width alphanumeric character, period “.”, hyphen “-”; Max.: 16 Characters	○

\* The “Setup Option” indication is explained below to indicate in the diagram whether a value input is omissible (a blank is used) or not.

The “○” indicates where it is omissible.

The “×” indicates where is not omissible, or is selected from an item menu.

# 4.9. Relay Contact Output Setup Screen

Each output control can be set up for relay-contact output. With this screen, the interchange between "Digital Output" and "BUSY Output" functions can be set up.

**[Setup Method]**

- ① . Select among "Digital Output" or "BUSY Output" for the relay-contact output function.
  - Refer to "4.9.1 Digital Output Mode Setup" for details when using it in the digital output mode.
  - Refer to "4.9.2 BUSY Output Mode Setup" for details when using it in the BUSY output mode.

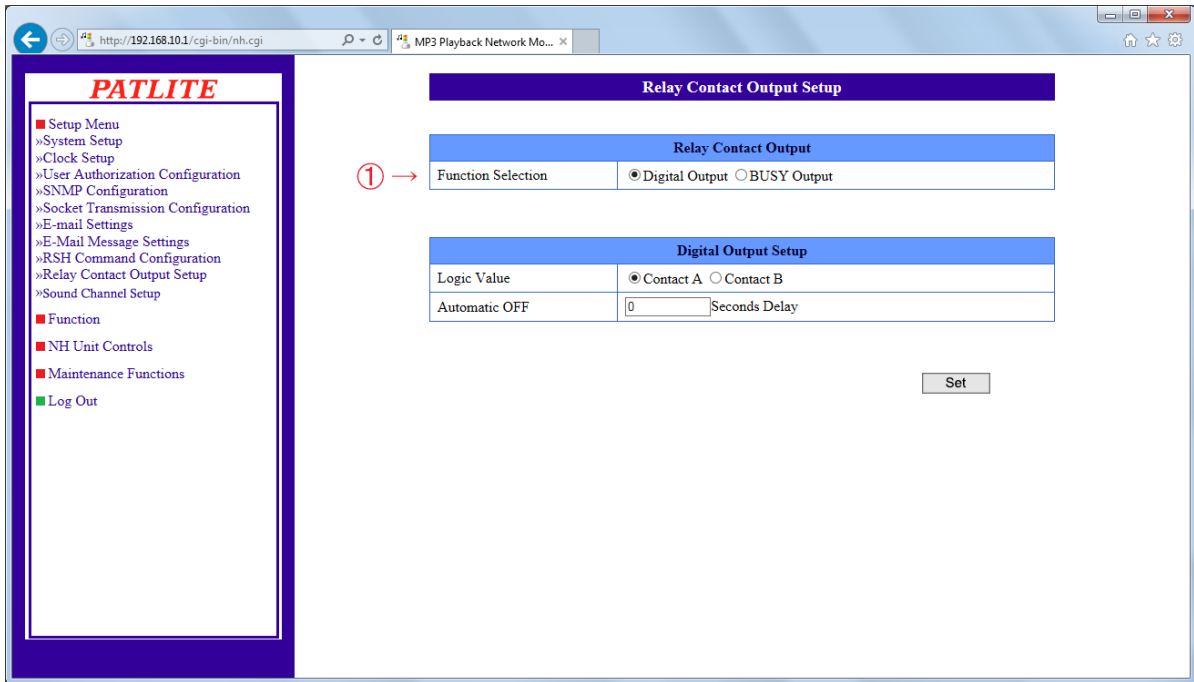

Figure 4.9.0-1 Relay Contact Output Setup Screen

Table 4.9.0-1 Relay Contact Output Setup Parameters

Item	Contents	Default Value	Input Parameter	Setup Option
Function Selection	Select among "Digital Output"/"BUSY Output" for the relay-contact output function.	Digital Output	*	x

\* The "Setup Option" indication is explained below to indicate in the diagram whether a value input is omissible (a blank is used) or not.

The "x" indicates where is not omissible, or is selected from an item menu.

## 4.9.1. Digital Output Mode Setup

Refer to "Table 4.9.1-1 Digital Output Setup Parameters" for the digital output mode in the relay-contact output setup screen.

**[Setup Method]**

- ② . Select the logical value "Contact A" or "Contact B" for the relay-contact output.
- ③ . Enter the number of seconds (0-600) for the "Automatic OFF" function.
  - If "0" is entered, the "Automatic OFF" function becomes inactive.
- ④ . Click the "Set" button to activate the setup.

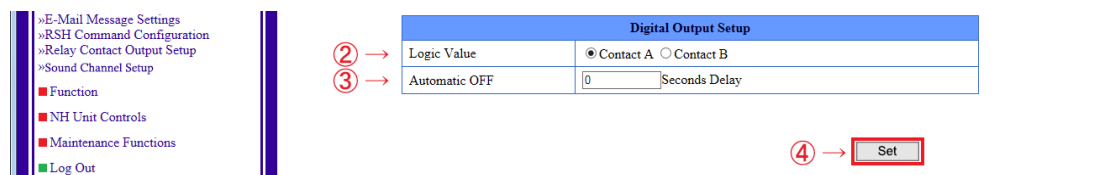

Figure 4.9.0-2 Relay Contact Output Digital Output Setup Screen

Table 4.9.1-1 Digital Output Setup Parameters

Item	Contents	Default Value	Input Parameter	Setup Option
Logic Value	Select between "Contact A" or "Contact B."	Contact A	—	×
Automatic OFF	Enter the time for the "Automatic OFF" function.	0	Half-width digits 0-600 (Seconds)	×

**MEMO** Refer to "Refer to "3.2.5 Relay Contact Output Control Function" for details on the digital output operation.

**Attention** The relay contact status is maintained from the BUSY output in case of a change from the digital output.  
A digital output is started by operating a digital output or executing a "Clear" operation.

## 4.9.2. BUSY Output Mode Setup

Refer to "Table 4.9.2-1 BUSY Output Setup Parameters" for the relay-contact output in the set up screen.

### [Setup Method]

- ②. Enter the number of seconds (0-10) for the "Sound Output delay" function.  
If a "0" is entered, the "Sound Output delay" function becomes inactive.
- ③. Click the "Set" button to activate the setup.

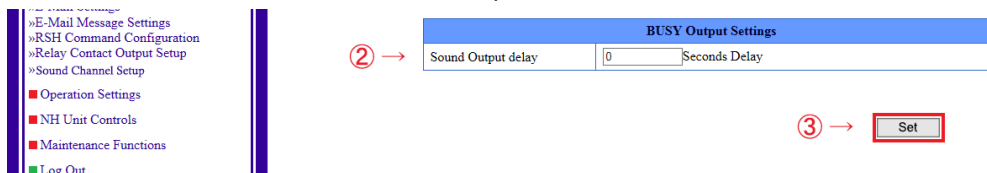

Figure 4.9.0-3 Relay Contact Output BUSY Output Setup Screen

Table 4.9.2-1 BUSY Output Setup Parameters

Item	Contents	Default Value	Input Parameter	Setup Option
Sound Output delay	Enter the delay time for the BUSY output.	0	Half-width digits 0-10 (Seconds)	○

**MEMO** Refer to "3.2.5 Relay Contact Output Control Function" on how to operate the BUSY output.

**Attention** The relay contact status is maintained from the digital output in case of a change from the BUSY output.  
When Channels 1-60 set as active for the lineout are operated to play back, the BUSY output starts upon playback.

\* The "Setup Option" indication is explained below to indicate in the diagram whether a value input is omissible (a blank is used) or not.

The "○" indicates where it is omissible.

The "×" indicates where is not omissible, or is selected from an item menu.



## 4.10. Sound Channel Setup Screen

The MP3 file and title to a channel which are reproduced by this product can be registered. In addition, a preview function is available to check the contents of the registered files.

### [Setup Method]

- ① Click the pull down menu to select the range of channels to set up.  
When changing the registered Playlist Package channels, select from the pull down menu "Playlist Data (channel 1-15) or (channel 16-30)."  
Refer to "4.10.1 Playlist Data (Ch1-Ch15, Ch16-Ch30)" for the parameters that can be set up.  
When registering an MP3 file, use the pull down menu in the "Web setup tool (channel31-channel40), (channel41-channel50), (channels 51-60)" to select the range.  
Refer to "4.10.2 Web Setup Data (Ch31-Ch40, Ch41-Ch50, Ch51 - Ch60)" for parameters that can be set up.

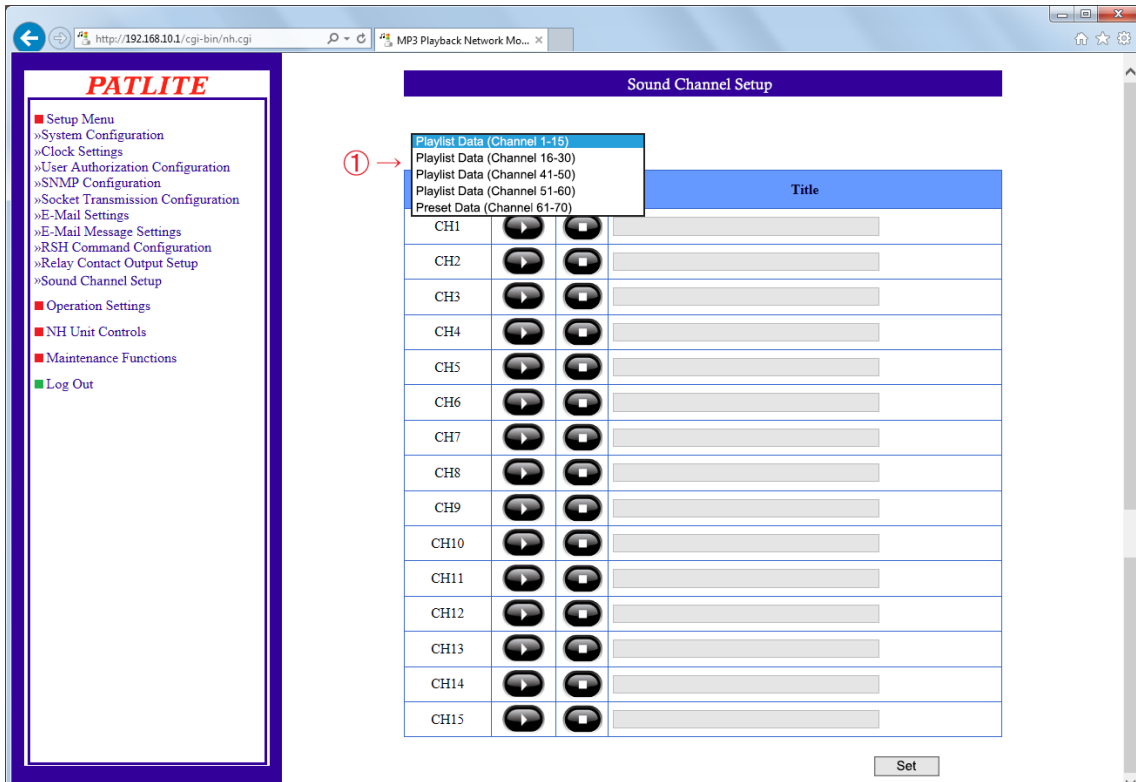

Figure 4.10.0-1 Sound Channel Setup Screen

Table 4.10.0-1 Sound Channel Setup Parameters

Item	Contents	Default Value	Input Parameter	Setup Option
—	Select the channel which is set up.	Playlist Data (Channels 1-15)	*	×

\* The "Setup Option" indication is explained below to indicate in the diagram whether a value input is omissible (a blank is used) or not.

The "x" indicates where is not omissible, or is selected from an item menu.

#### 4.10.1. Playlist Data (Ch1-Ch15, Ch16-Ch30)

The playlist data parameters that can be set up in the audio channel setup screen are indicated in "Table 4.10.0–1 Sound Channel Setup Parameters".

##### [Setup Method]

- ② . Clicking the button will play back the selected channel from the Main Unit speaker and lineout (when activated).
- ③ . Clicking the button again will stop the channel currently being played back.
- ④ . Register a title into the "title" field for the channel.
- ⑤ . If using the lineout, set it to "Active".
- ⑥ . Click the "Set" button to save the changes of the contents and registration.

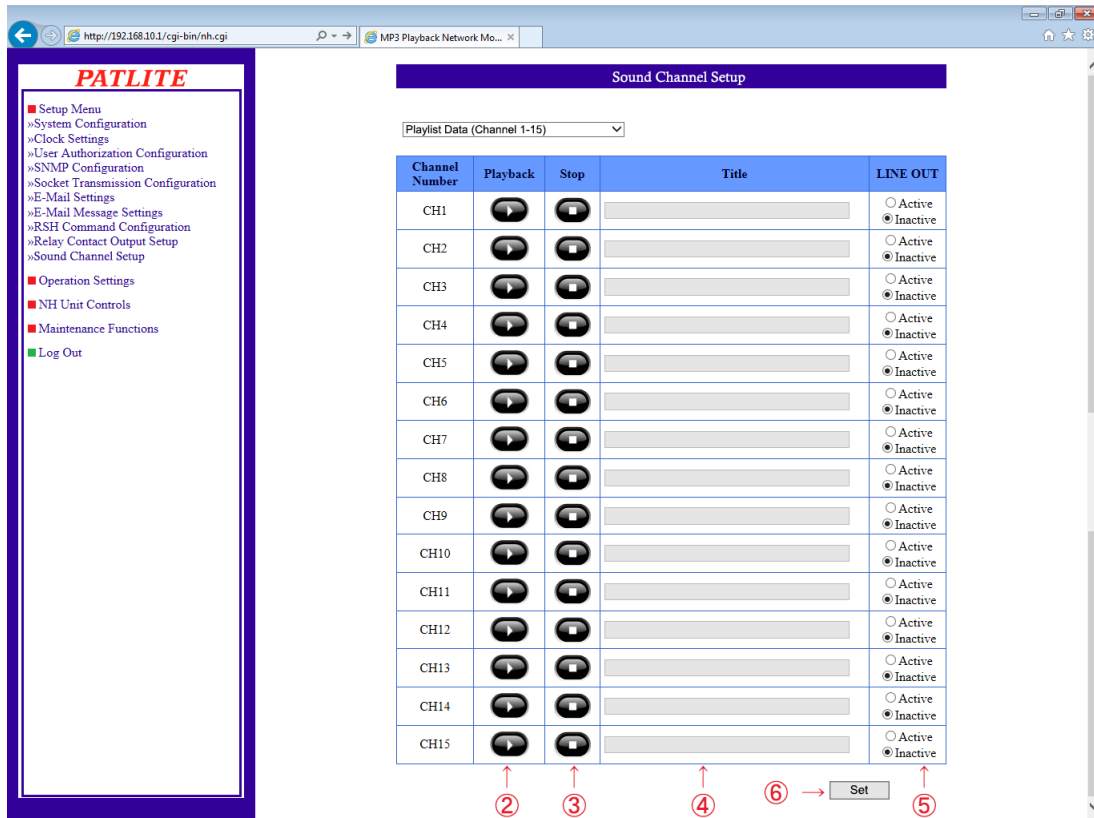

Figure 4.10.1–1 Sound Channel Playlist Data Setup Screen

Table 4.10.1–1 Sound Channel Data Setup Parameters

Item	Contents	Default Value	Input Parameter	Setup Option
Playback	The selected channel is played back.	*	*	×
Stop	The selected channel is stopped.	*	*	×
Title	Enter the title for the channel.	Blank	Full or half size; Max. 31 Char.	○
LINEOUT	Select "Active" or "Inactive" for LINEOUT.	Inactive	*	×

\* The "Setup Option" indication is explained below to indicate in the diagram whether a value input is omissible (a blank is used) or not.

The "○" indicates where it is omissible.

The "×" indicates where is not omissible, or is selected from an item menu.

##### Attention

- The Playlist Package cannot be changed from the Sound Channel Setup Screen. Rearrange the channels in the Playlist Package with the "PATLITE Playlist Editor 2" for functions like deleting or editing channels before registering them to this product.
- Since the preview operates in accordance with the channel playback and LINEOUT function set up, if the BUSY output function is enabled when previewing, verify whether the connected devices operate satisfactory before previewing.
- If playback preview is played, the channel in playback will be interrupted.
- In the memory playback mode, when an event is occurs during preview playback, it is played back after the preview is completed.

## 4.10.2. Web Setup Data (Ch31-Ch40, Ch41-Ch50, Ch51 - Ch60)

"Table 4.10.2-1 Sound Channel Setup Tool Parameters" lists the parameters which can be set up for the Web Setup Data in the Sound Channel Setup Screen.

### [Setup Method]

- ② . Select the registered channel number to change from the pull down menu.
- ③ . Select the MP3 file to register for the channel.
- ④ . Register a title into the "title" field for the channel.

Click the "File Upload" button, to start uploading the MP3 file into the Main Unit.

When the message, "The writing of an MP3 file was completed" is displayed, the procedure is completed.

The following steps can perform the following functions for the channel registered with the MP3 file.

- ⑤ . Clicking the button will play back the selected channel from the Main Unit speaker and lineout (when LINEOUT is activated).
- ⑥ . Clicking the button again will stop the channel currently being played back.
- ⑦ . Register a title into the "title" field for the channel.
- ⑧ . Set the lineout to "Active" when using it.
- ⑨ . Click the "Set" button for the changes to take effect.

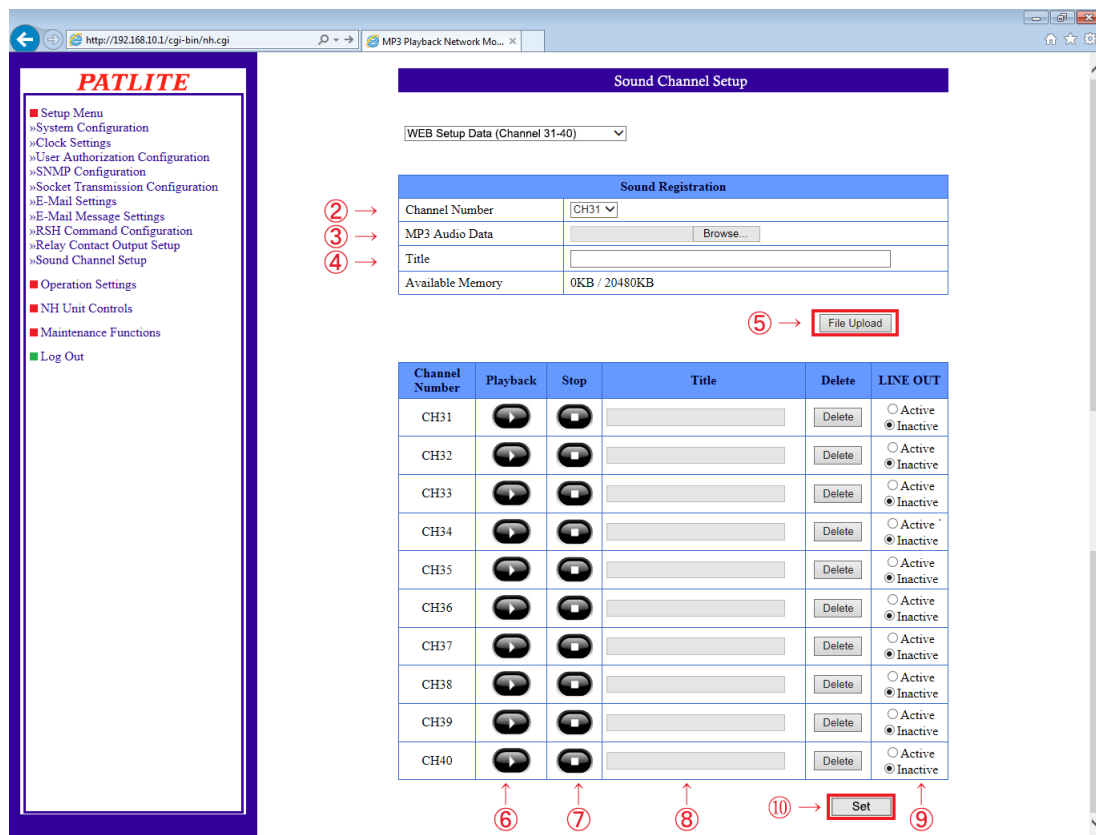

Figure 4.10.2-1 Sound Channel Web Setup Tool Screen

Table 4.10.2-1 Sound Channel Setup Tool Parameters

Item	Contents	Default Value	Input Parameter	Setup Option
Channel Number	The channel which is set up is selected.	Ch. 31, 41, 51 for all pages.	*	×
MP3 Audio data	Set up the registered MP3 file.	Blank	*	×
Title	Enter the title for the channel.	Blank	Full or half size; Max. 31 Char.	○
Playback	The selected channel is played back.	*	*	×
Stop	The selected channel is stopped.	*	*	×
Title	Enter the title for the channel.	Blank	Full or half size; Max. 31 Char.	○
LINEOUT	Select "Active" or "Inactive" for LINEOUT.	Inactive	*	×

\* The "Setup Option" indication is explained below to indicate in the diagram whether a value input is omissible (a blank is used) or not.

The "O" indicates where it is omissible.

The "x" indicates where is not omissible, or is selected from an item menu.

**Attention**

- The sum total file size which can be registered for channels 31-60 is 20 MB.
- When the MP3 file to be registered is recorded in stereo, playback is sent through the left (L) channel side of the MP3 file to the Main Unit speaker. When the MP3 file to be registered is recorded in stereo, playback is sent through the left (L) channel side of the MP3 file to the Main Unit speaker. The right (R) side channel lineout output is from the left (L) channel signal line of the MP3 file.
- A file with a fixed bit rate of more than 128k bps cannot be uploaded.
- Encoded MP3 files not compatible with the fixed bit rate for this product will not guarantee playback operation.
- Since the preview operates in accordance with the channel playback and lineout function set up, if the BUSY output function is enabled when previewing, verify whether the connected devices operates satisfactory before previewing.
- If playback preview is played, the channel in playback will be interrupted.

**MEMO**

- In the memory playback mode, when an event occurs during preview playback, it is played back after the preview is completed.
- When the title area is blank, uploading an MP3 file will automatically set the MP3 file title.

### 4.10.3. Preset Channel (Channel 61-70)

Refer to "Table 4.10.3-1" for the parameters which can be operated from the Preset Sound Channel Preview Screen.

**[Setup Method]**

- ② . The click of a button will reproduce a channel from the Main Unit loudspeaker.
- ③ . The click of a button will suspend the channel currently reproduced from the Main Unit loudspeaker.

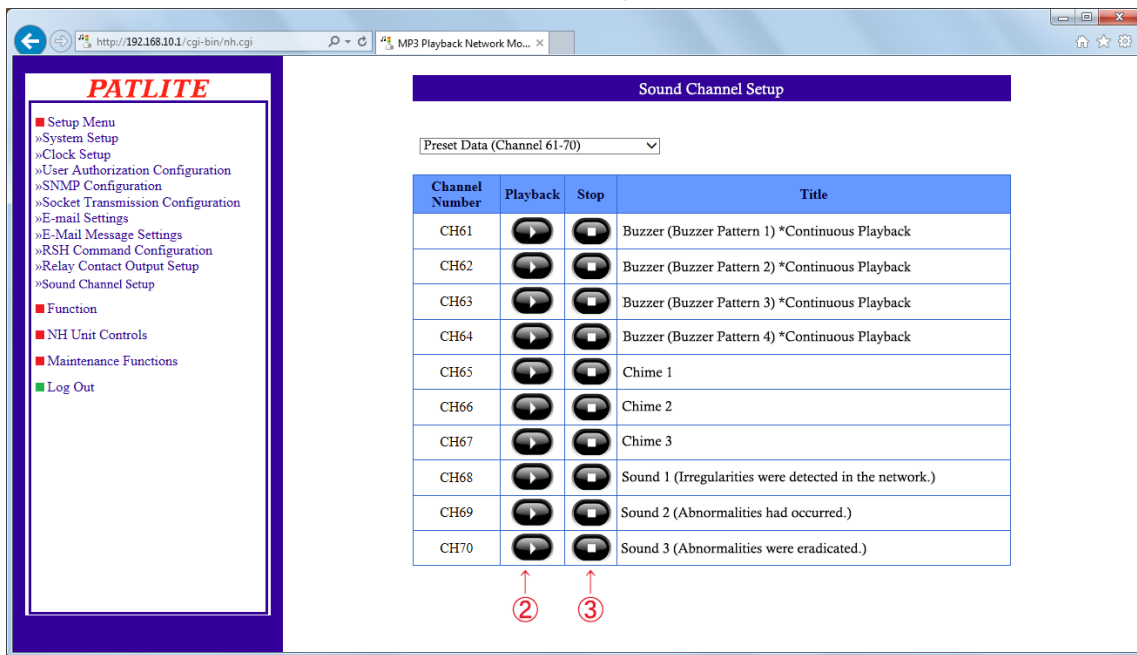

Figure 4.10.3-1 Preset Sound Channel Preview Screen

Table 4.10.3-1 Preset Sound Channel Preview Parameters

Item	Contents	Default Value	Input Parameter	Setup Option
Playback	The selected channel is played back.	*	*	x
Stop	The selected channel is stopped.	*	*	x

**Attention**

- A preset channel cannot be changed or deleted.
- A preset channel cannot be used for the lineout.
- Channels 61-64 may vary in operation during memory playback in comparison to other channels. Refer to "3.1.7 Playback mode" for details.
- If playback preview is played, the channel in playback will be interrupted.
- In the memory playback mode, when an event occurs during preview playback, It is played back after the preview is completed.

\* The "Setup Option" indication is explained below to indicate in the diagram whether a value input is omissible (a blank is used) or not.

The "x" indicates where is not omissible, or is selected from an item menu.

## 4.11. Scheduling Setup Screen

Set up a schedule.

### [Setup Method]

- (1) (1) Select "Active" or "Inactive" in the "Schedule function" field.  
To use the schedule function, set it to "Active".
- (2) (2) Select the time period of the schedule for every day of the week.  
If "24 hours" is selected, the all-day schedule function will be activated and no notifications will be given.  
When "Operating Duration" is selected, the schedule function is effective only for the operating duration.
- (3) (3) Specify the operating duration when the schedule function is enabled.  
Place a check mark in the time you want to start and end the operating duration.

Figure 4.11.0-1 Scheduling Setup Screen

Table 4.11.0-1 Scheduling Setup Parameters

Item	Contents	Default Value	Input Parameter	Setup Option
Schedule function	Select "Active" or "Inactive" in the Schedule function field.	Inactive	*	×
Validity Period	Select the schedule valid period for each day of the week in the "24 hours" or "Operating Duration" fields	Operating Duration	*	×
Time range 1	Set up the start and finish time for time range 1.	00:00 - 00:00	00:00 to 24:00 in increments of 15 min.	×
Time Range 2	Set up the start and finish time for time range 2.	00:00 - 00:00		×
Time Range 3	Set up the start and finish time for time range 3.	00:00 - 00:00		×

\* The "Setup Option" indication is explained below to indicate in the diagram whether a value input is omissible (a blank is used) or not.

The "O" indicates where it is omissible.

The "x" indicates where is not omissible, or is selected from an item menu.

#### MEMO

- ◆ When the check is removed, the schedule function will revert to "Inactive" and it will return to normal notification.
- ◆ To set the time range, enter the time in order, from the start time to the end time.

## 4.12. Digital Input Setup Screen

The operation for when a digital input status change occurs is set up. Refer to "Table 4.12.3-1 Digital Input Setup Parameters" for the parameters set up in the Digital Input Setup Screen.

### [Setup Method]

- ① Select the port number (1-4) to set up for the input control.
- ② Select "Active" in order to activate the function.
- ③ Select the logical value (A contact/B contact) for the input control port.
- ④ Select "ON Status Change", "OFF Status Change", or "Status Change" to define the signal.
- ⑤ Set up the operation for when there is a signal present.
- ⑥ Select the E-mail Sending Setup for when a signal is present.  
If the E-mail Sending is made "Active", the "E-mail Receiver" is selected for "subject" and "message" after activation.
- ⑦ Select "Active" when using the TRAP transmission.

< The "TRAP Command" for this product to receive when the TRAP condition occurs >

When the Digital Input is turned "ON":

OID [1.3.6.1.4.1.20440.4.1.6.11]

Name: [trapPatliteDiStateChangeON]

When the Digital Input is turned "OFF":

OID [1.3.6.1.4.1.20440.4.1.6.12]

Name: [trapPatliteDiStateChangeOFF]

Referring to "4.9 Relay Contact Output Setup Screen", when selecting a digital output, it is shown in "Digital Output"

< Signal definition "Screen display when selecting "ON Status Change" and "OFF Status Change" >

- ⑧ Select an operation for the digital output among "ON", "OFF", and "No Change."
- ⑨ Select the setup for the digital input condition to clear.
- ⑩ Click the "Set" button to activate the setup.

Figure 4.12.3-1 Digital Input Setup Screen (when [ "ON Status Change " ] is selected)

### MEMO

When the signal definition is set to "OFF Status Change", the "ON Status Change for Operation Setting 1" is displayed as "OFF Status Change for Operation Setting 1."

< Screen display when selecting "Status Change" by signal definition >

When the "Status Change" is selected for the signal definition, the setup parameters in the Setup Screen are described in "Table 4.12.3-1 Digital Input Setup Parameters".

The operation setting input column is displayed for both the "at time of ON condition change", and the "at time of OFF condition change."

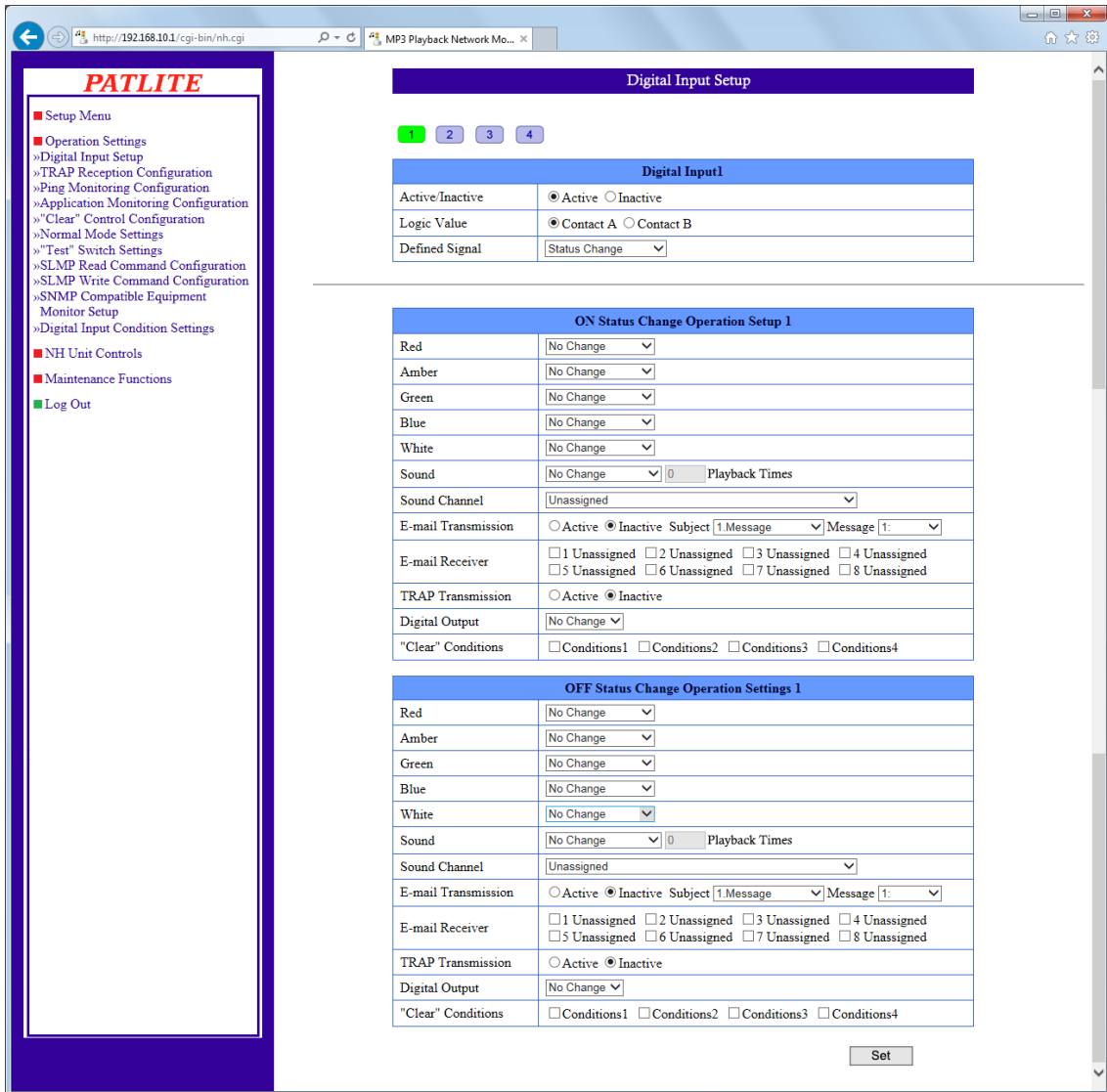

4

Figure 4.12.3-2 Digital Input Setup Screen (when "Status Change" is selected)

Table 4.12.3-1 Digital Input Setup Parameters

Item	Contents	Default Value	Input Parameter	Setup Option
Active/Inactive	"Active" - "Inactive" of a digital input function is selected.	Active	*	×
Logic Value	A logical value is selected between "Contact A" - "Contact B."	Contact A	*	×
Trigger Signal	Select from "ON Status", "OFF Status", "Status Change" for signal definition.	ON Status	*	×
Red/Amber/Green/Blue/White	Select from "On", "flashing 1", "flashing 2", "Off", "No Change" for each Signal Tower color.	No Change	*	×
Sound	Select an audio playback pattern from "Stop", "One-shot Playback", "Repeat Playback", and "No Change."	No Change	*	×
Sound (When "Repeat Playback" is selected)	Set up the Repeat Playback. With a one shot playback at 0 playback times, 1-254 are the number of playback times specified (plus 1 playback time), and 255 playback times becomes an endless playback.	0	Half-width digit 0-255	×
Sound Channel	Select the registered channel to play back.	Unassigned	*	×
E-mail Transmission	Select E-mail Sending as "Active" or "Inactive."	Inactive	*	×
Subject	Select the E-mail title	1.Message	*	×
Message	Select the E-mail text	1:	*	×
E-mail Receiver	Select the recipient to send E-mail to.	Unassigned	*	×
TRAP Transmission	Select the TRAP Transmission for "Active" or "Inactive."	Inactive	*	×
Digital Output	The "Digital Output" selection will be displayed by the relay-contact output function. Select from "ON", "OFF", and "No Change" for the digital output.	No Change	*	×
"Clear" Condition	Select the conditions to reset the measured time for the digital input condition Setup.	Unassigned	*	×

\* The "Setup Option" indication is explained below to indicate in the diagram whether a value input is omissible (a blank is used) or not.

The "x" indicates where is not omissible, or is selected from an item menu.



## 4.13. TRAP Reception Configuration Screen

Setup for permitting a TRAP reception and the operation after the TRAP reception.

The parameter set on a TRAP reception setting screen is as in "Table 4.16.2-3 "Clear" Execution Setup Parameters (For SNMP and RSH Clear)".

### [Setup Method]

(The setting screen should see the following page)

- ① . Select a reception setting number (1-16).
- ② . Enter a group name.
- ③ . Enter a TRAP designated sender address. \*
- ④ . Receive in the "TRAP OID" column. OID of TRAP is entered. \*
- ⑤ . In the "variable bindings" column, the OID is entered. \*
- ⑥ . Set up operation of this product at the time of receiving TRAP.
- ⑦ . Select the E-mail Sending configuration when receiving a TRAP.  
If the E-mail Sending is made "Active", the "E-mail Receiver" is selected for "subject" and "message" after activation.
- ⑧ . In cases where it performs TRAP transmission, select "Active."

<< The "TRAP Command" this product receives when the TRAP condition occurs >>

OID [1.3.6.1.4.1.20440.4.1.6.3]

Name [trapPatliteTrapReceived]

Referring to "4.9 Relay Contact Output Setup Screen", when selecting a digital output, it is shown in "Digital Output."

- ⑨ . Select operation of a digital output from "ON", "OFF", and "No Change."
- ⑩ . Click the "Set" button to activate the setup.

\* Refer to the following below

#### MEMO

- When an item for the TRAP designated sender address is entered, the "TRAP OID" column and the "variable bindings" column can be omitted. When the "TRAP OID" column and the "variable-bindings" column are omitted, all operations rely upon the TRAP(s) transmitted from the address set up in the "TRAP designated sender address."
- When a "TRAP designated sender address name" is omitted, the operation is determined only by the TRAP number.
- For two "variable bindings", the 1st registration can be used among the existing registered items.
- The "variable bindings" can use a "half-width asterisk" (\*) at the end. If an asterisk (\*) is used, it will be considered that they are in agreement with the conditions, no matter what the last part of integral values might be.
- It won't operate when the "TRAP designated sender address" and "TRAP number" are omitted, even if the "variable bindings" was registered.
- When the TRAP Reception "GenericTrap type" is 6 (enterprisespecific), please add the value "0. (specific-trap value)" to the last part of the TRAP Reception to the specific-trap.

#### Attention

- The "TRAP OID" cannot be omitted when the "TRAP designated sender address" is omitted. When both the "TRAP designated sender address" and "TRAP OID" are omitted, no operation occurs after reception.
- When a TRAP number has been duplicated and is registered into the group, the least significant Setup number in the group is used. The following group number after that number is not used.
- Judgement can be made by the reception function with the number of variable-bindings of 64 per trap. To receive more than 64 variable bindings, the traps 1-64 must first be set to operate in the OID at the time of reception. Be aware that the OID after the 65th one does not operate, even after it is set.

4

**PATLITE**

- Setup Menu
  - Operation Settings
    - » Digital Input Setup
    - » TRAP Reception Configuration
    - » Ping Monitoring Configuration
    - » Application Monitoring Configuration
    - » "Clear" Control Configuration
    - » Normal Mode Settings
    - » "Test" Switch Settings
    - » SLMP Read Command Configuration
    - » SLMP Write Command Configuration
    - » SNMP Supported Equipment Monitor
    - » Digital Input Condition Settings
  - NH Unit Controls
  - Maintenance Functions
  - Log Out

TRAP Reception Configuration

1 2 3 4 5 6 7 8 9 10 11 12 13 14 15 16

**TRAP Reception Configuration Group**

Group Name1		
TRAP Source Address		
TRAP OID		
1	variable bindings1	OID: <input type="text"/> Type: integer Value: 0
	variable bindings2	OID: <input type="text"/> Type: integer Value: 0
TRAP Source Address		
TRAP OID		
2	variable bindings1	OID: <input type="text"/> Type: integer Value: 0
	variable bindings2	OID: <input type="text"/> Type: integer Value: 0
TRAP Source Address		
TRAP OID		
3	variable bindings1	OID: <input type="text"/> Type: integer Value: 0
	variable bindings2	OID: <input type="text"/> Type: integer Value: 0
TRAP Source Address		
TRAP OID		
4	variable bindings1	OID: <input type="text"/> Type: integer Value: 0
	variable bindings2	OID: <input type="text"/> Type: integer Value: 0

**Operation Setting for TRAP Reception 1**

Red	[No Change] ▾
Amber	[No Change] ▾
Green	[No Change] ▾
Blue	[No Change] ▾
White	[No Change] ▾
Sound	[No Change] ▾ 0 Playback Times
Sound Channel	[Unassigned] ▾
E-mail Transmission	<input type="radio"/> Active <input checked="" type="radio"/> Inactive Subject [1.Message] ▾ Message [1:] ▾
E-mail Receiver	<input type="checkbox"/> 1 Unassigned <input type="checkbox"/> 2 Unassigned <input type="checkbox"/> 3 Unassigned <input type="checkbox"/> 4 Unassigned <input type="checkbox"/> 5 Unassigned <input type="checkbox"/> 6 Unassigned <input type="checkbox"/> 7 Unassigned <input type="checkbox"/> 8 Unassigned
TRAP Transmission	<input type="radio"/> Active <input checked="" type="radio"/> Inactive
Digital Output	[No Change] ▾

10 → Set

Figure 4.13.3-1 TRAP Reception Configuration Screen

Table 4.13.0–1 TRAP Reception Configuration Parameters

Item	Contents	Default Value	Input Parameter	Setup Option
Group Name	A group's name is entered.	Blank	Except for a half-width apostrophe "'" (Full size or half size): Max: 32 Characters	○
TRAP Source Address	Enter the designated sender address of the TRAP to be received.	Blank	IP Address Format	○
TRAP OID	Enter theOID of the TRAP to be received.	Blank	A number and "." (period) Max.: 127 Characters	○
OID (variable-bindings)	Enter the OID variable-bindings to be received.	Blank	A number and "." (period) "*" (only used at the end) Max.: 127 Characters	○
Type (variable-bindings)	The type of OID of variable-bindings to receive is selected from "integer" or "string."	integer	*	×
Value (variable-bindings)	Enter the variable-bindings value to be received.	0	Number (0-2147483647) Or half width Max.: 63 Characters	○
Red/Amber/Green/Blue/White	Select from "On", "Flashing 1", "Flashing 2", "Off", "No Change" for each Signal Tower color.	No Change	*	×
Sound	Select a sound playback pattern from "Stop", "One-shot Playback", "Repeat Playback", and "No Change."	No Change	*	×
Sound (When "Repeat Playback" is selected)	Set up the Repeat Playback. With a one shot playback at 0 playback times, 1-254 are the number of playback times specified (plus 1 playback time), and 255 playback times becomes an endless playback.	0	Half-width digits 0-255	×
Sound Channel	Select the registered channel.	Unassigned	*	×
E-mail Transmission	Select E-mail Sending as "Active" or "Inactive."	Inactive	*	×
Subject	Select the E-mail title	1.Message	*	×
Message	Select the E-mail text	1:	*	×
E-mail Receiver	Select the recipient to send E-mail to.	Unassigned	*	×
TRAP Transmission	Select the TRAP transmission for "Active" or "Inactive."	Inactive	*	×
Digital Output	The "Digital Output" selection will be displayed by the relay-contact output function. The digital output can be selected among; "ON", "OFF", and "No Change".	No Change	*	×

\* The "Setup Option" indication is explained below to indicate in the diagram whether a value input is omissible (a blank is used) or not. The "O" indicates where it is omissible.

The "x" indicates where is not omissible, or is selected from an item menu.

## 4.14. Ping Monitoring Configuration Screen

The Ping monitor can be set up.

When the Ping monitor detects an abnormality, as a result, it generates a monitor abnormality condition. After a monitor abnormality is generated, if there is a response from a Ping request, it will then determine a recovery from the abnormal condition, and will continue its normal operate after restoration.

A maximum number of 24 Ping monitors can be registered.

### [Setup Method]

- ① . Select the screen setup numbers from No. 1-20, to setup the Ping monitoring parameters.
- ② . Enter the IP address for a target to monitor.
- ③ . Enter the device name for a target to monitor.
- ④ . Enter a Cycle count Error threshold value (0-30).
- ⑤ . Enter the number of seconds for a Ping test cycle period (1-600).
- ⑥ . Enter the value for the Pings per test cycle (1-3).

<< Operation Setting for Monitoring Abnormality >>

- ⑦ . Perform operation setting of this product when monitor abnormality occurs.
- ⑧ . Select an E-mail Sending Setup when monitor abnormality occurs.  
If the E-mail Sending is made "Active", the "E-mail Receiver" is selected for "subject" and "message" after activation.
- ⑨ . In cases where it performs TRAP transmission, select "Active."

<< The "TRAP Command" this product receives when the TRAP condition occurs >>

OID [1.3.6.1.4.1.20440.4.1.6.1]

Name [trapPatliteAlarmAdded]

Referring to "4.9 Relay Contact Output Setup Screen", when selecting a digital output, it is shown in "Digital Output."

- ⑩ . Select operation of a digital output from "ON", "OFF", and "No Change."

Figure 4.14.0-1 Ping Monitoring Configuration Screen No. 1

<< Operation Setting for Recovering Monitoring Abnormality >>

- ⑪ . Set up the operation setting for this product to recover from monitoring abnormality.
- ⑫ . Use the E-mail Sending Setup when recovering from monitoring abnormality.  
If the E-mail Sending is made "Active", the "E-mail Receiver" is selected for "subject" and "message" after activation.
- ⑬ . When using the TRAP transmission, select "Active."

<< The "TRAP Command" for this product to receive when the TRAP condition occurs >>

OID [1.3.6.1.4.1.20440.4.1.6.2]

Name [trapPatliteAlarmRecover]

Referring to "4.9 Relay Contact Output Setup Screen", when selecting a digital output, it is shown in "Digital Output."

⑭ . Select operation of a relay contact from "ON", "OFF", and "No Change."

⑮ . Click the "Set" button to activate the setup.

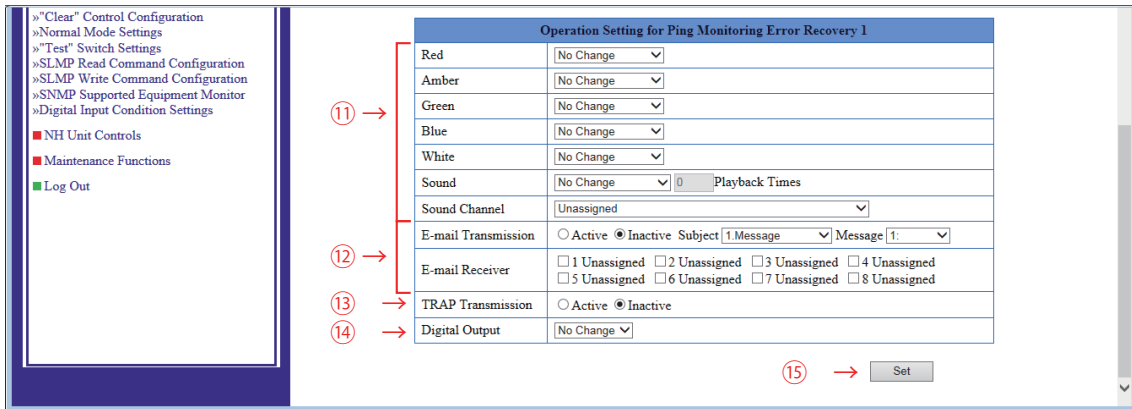

Figure 4.14.0-2 Ping Monitoring Configuration Screen No. 2

Table 4.14.0-1 Ping Monitoring Configuration Parameters

Item	Contents	Default Value	Input Parameter	Setup Option
Monitoring Target Address	Enter the IP address or host name for the ping monitoring.	Blank	Characters which can be used for the IP address and host name. Max. 63 Characters	○
Equipment Name	Enter the name for the Ping transmission monitoring.	Blank	Full or half-size (excluding the half-width apostrophe "'"): Max.: 32 Char.	○
Cycle count Error threshold	The duration of a monitoring cycle to test and determine network response.	0	Half-width digits 0-30 (times)	×
Ping test cycle period	Enter the period which transmits the Ping.	60	1-600 (sec.)	×
Pings per test cycle	The number of Pings to send in the test cycle.	1	1-3 Pings	×
Red/Amber/Green/Blue/White	Select each color among "On", "Flashing 1", "Flashing 2", "OFF", "No Change".	No Change	*	×
Sound	Select an audio playback pattern among "Stop", "One-shot Playback", "Repeat Playback", and "No Change."	No Change	*	×
Sound (When "Repeat Playback" is selected)	Repeat Playback can be set up. With a one shot playback at 0 playback times, 1-254 are the number of repeated playback times specified (plus 1 playback time), and 255 playback times becomes an endless playback.	0	Half-width digits 0-255	×
Sound Channel	Select the registered channel.	Unassigned	*	×
E-mail Transmission	Select E-mail Sending as "Active" or "Inactive."	Inactive	*	×
Subject	Select the E-mail title.	1.Message	*	×
Message	Select the E-mail text.	1:	*	×
E-mail Receiver	Select the recipient to send E-mail to.	Unassigned	*	×
TRAP Transmission	Select the TRAP transmission for "Active" or "Inactive."	Inactive	*	×
Digital Output	The "Digital Output" selection will be displayed by the relay-contact output function. Select from "ON", "OFF", and "No Change" for the digital output.	No Change	*	×

\* The "Setup Option" indication is explained below to indicate in the diagram whether a value input is omissible (a blank is used) or not.

The "O" indicates where it is omissible.

The "x" indicates where is not omissible, or is selected from an item menu.

## 4.15. Application Monitoring Configuration Screen

Setup for monitoring an application. The data reception of the target is monitored.

If data is not received within the monitoring interval cycle, it detects a monitor abnormality, and generates an abnormality event. After a generated event, if data is received from the monitored candidate, it will detect a recovery from the abnormal operation.

### [Setup Method]

- ① . Select a number between 1 and 4 for four different application monitor Setups.
- ② . Enter the IP address for a target to monitor. (When an abbreviation or 0 is entered, the monitoring function becomes inactive)
- ③ . Enter a receiving port number (0, or 9000-9999).
- ④ . Enter a device name.
- ⑤ . Enter the number of seconds of a monitoring interval (0-60000).

<< Operation Setting for Monitoring Abnormality >>

- ⑥ . Set the operation up for this product when monitor abnormality occurs.
- ⑦ . Select from the E-mail Sending Setup when monitor abnormality occurs.  
If the E-mail Sending is made "Active", the "E-mail Receiver" is selected for "subject" and "message" after activation.
- ⑧ . When using the TRAP transmission, select "Active."

<< The "TRAP Command" this product receives when the TRAP condition occurs >>

OID [1.3.6.1.4.1.20440.4.1.6.6]

Name [trapPatliteAppMonitorAlarmAdded]

Referring to "4.9 Relay Contact Output Setup Screen", when selecting a digital output, it is shown in "Digital Output."

- ⑨ . Select operation of the digital output between "ON", "OFF", and "No Change."  
(Continue to the following page)

The screenshot shows the 'Application Monitoring Configuration' screen. The left sidebar contains a 'Setup Menu' with options like 'Operation Settings', 'Digital Input Setup', 'TRAP Reception Configuration', etc. The main area is divided into two sections. The top section, 'Monitoring Target Application1', contains four input fields: 'Monitoring Target Address', 'Reception Port Number (9000-9999)', 'Equipment Name', and 'Monitoring Interval (0-60000Seconds)'. The bottom section, 'Operation Setting for Application Monitoring Error 1', contains several rows of settings, each with a dropdown menu or radio buttons. The settings include color indicators (Red, Amber, Green, Blue, White), sound settings (Sound, Sound Channel), email settings (E-mail Transmission, E-mail Receiver), TRAP Transmission, and Digital Output. Red arrows and numbers 1 through 9 are overlaid on the image to indicate the steps described in the text.

Figure 4.15.3-1 Application Monitoring Configuration Screen No. 1

<< Operation Setting for Recovering Monitoring Abnormality >>

- ⑩ . Set up the operation setting for this product to recover from monitoring abnormality.
- ⑪ . Select the E-mail Sending Setup when restoring from a monitor abnormality.  
If the E-mail Sending is made "Active", the "E-mail Addressee" is selected for "subject" and "text" after activation.
- ⑫ . When using the TRAP transmission, select "Active."

<< The "TRAP Command" for this product to receive when the TRAP condition occurs >>

OID [1.3.6.1.4.1.20440.4.1.6.7]

Name "trapPatliteAppMonitorAlarmRemoved"

Referring to "4.9 Relay Contact Output Setup Screen", when selecting a digital output, it is shown in "Digital Output."

- ⑬ . Select the digital output operation between "ON", "OFF", and "No Change."
- ⑭ . Click the "Set" button to activate the setup.

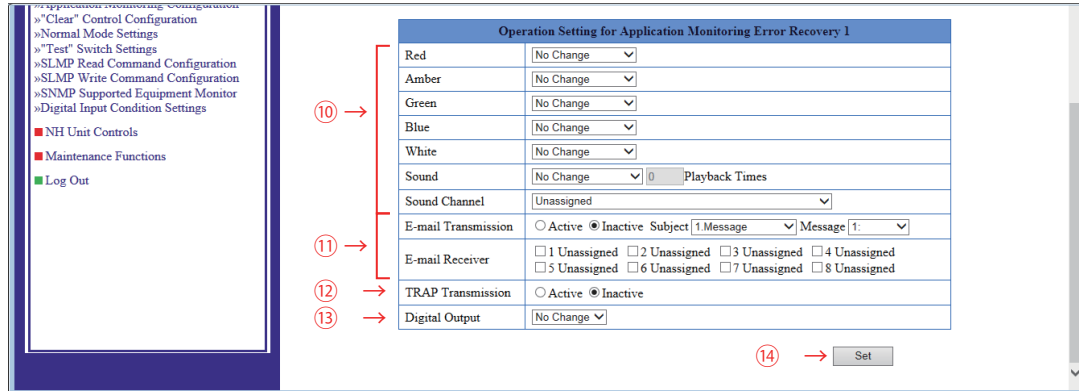

Figure 4.15.0-1 Application Monitoring Configuration Screen No. 2

Table 4.15.0-1 Application Monitoring Configuration Parameters

Item	Contents	Default Value	Input Parameter	Setup Option
Monitoring Target Address	The IP address covering transmission monitoring is entered.	Blank	IP Address Format	○
Reception Port Number	The receiving port used for an application monitor is entered.	0	Half-width digit 0, 9000-9999	×
Equipment Name	Enter the name for the transmission monitoring.	Blank	Full or half-size (excluding the half-width apostrophe """): Max.: 32 Characters	○
Monitoring Interval	Enter the time interval to receive data.	0	Half-width digit 0: Monitor Invalidity 1-60000 (sec.)	○
Red/Amber/Green/Blue/White	Select each color among "On", "flashing 1", "flashing 2", "OFF", "No Change".	No Change	*	×
Sound	Select an audio playback pattern from "Stop", "One-shot Playback", "Repeat Playback", and "No Change."	No Change	*	×
Sound (When "Repeat Playback" is selected)	Set up the Repeat Playback. With a one shot playback at 0 playback times, 1-254 are the number of playback times specified (plus 1 playback time), and 255 playback times becomes an endless playback.	0	Half-width digit 0-255	×
Sound Channel	Select the registered channel.	Unassigned	*	×
E-mail Transmission	Select E-mail Sending as "Active" or "Inactive."	Inactive	*	×
Subject	Select the E-mail title	1.Message	*	×
Message	Select the E-mail text	1:	*	×
E-mail Receiver	Select the recipient to send E-mail to.	Unassigned	*	×
TRAP Transmission	Select the TRAP transmission for "Active" or "Inactive."	Inactive	*	×
Digital Output	The "Digital Output" selection will be displayed by the relay-contact output function. Select from "ON", "OFF", and "No Change" for the digital output.	No Change	*	×

\* The "Setup Option" indication is explained below to indicate in the diagram whether a value input is omissible (a blank is used) or not.

The "○" indicates where it is omissible.

The "×" indicates where is not omissible, or is selected from an item menu.



## 4.16. "Clear" Control Configuration Screen

When the "Clear" switch is pushed, it can be set up for transmitting e-mail, TRAP, and SLMP write command in accordance with the conditions that a clear has been made by the SNMP or RSH command.

### 4.16.1. "Clear" Control Configuration ("CLEAR" Button)

The following is the setup and operation when the "Clear" switch has been pushed.

#### [Setup Method]

- ① . To use the "Clear" switch function, select "Active."
- ② . Select the E-mail Sending Setup for when the "Clear" switch has been pressed.  
If the E-mail Sending is made "Active", the "E-mail Receiver" is selected for "subject" and "message" after activation.
- ③ . When using the TRAP transmission, select "Active."

<< The "TRAP Command" this product receives when the TRAP condition occurs >>

OID [1.3.6.1.4.1.20440.4.1.6.4]

Name "trapPatliteClearExecuted"

- ④ . When using the SLMP write command transmission, select "SLMP Write Command Transmission Receiver."
- ⑤ . Select the type of clear for the Signal Tower when the clear switch is pushed during playback, with "Clear All" or "Press twice to clear all."  
In "4.1 System Setup Screen" where the "memory playback mode" is selected, the "Sound" is displayed.
- ⑥ . When clearing is during channel playback, select the operation for "Stop" or "Sending Music."
- ⑦ . When the "Clear" switch is pushed, select "Inactive" to prevent the Signal Tower lights to stay on.
- ⑧ . Click the "Set" button to activate the setup.

The screenshot shows the "Clear" Control Configuration screen. On the left is a navigation menu for PATLITE. The main content area is titled "Clear Control Configuration" and is divided into three main sections: "CLEAR Button", "SNMP Clear", and "RSH Clear".

- "CLEAR" Button Section:**
  - "Clear" Switch Function:  Active  Inactive
  - E-mail Transmission:  Active  Inactive. Subject: [1.Message] Message: [1.]
  - E-mail Receiver: 8 checkboxes (1-8) labeled "Unassigned".
  - TRAP Transmission:  Active  Inactive
  - SLMP Write Command Transmission Receiver: 4 checkboxes (1-4) labeled "Unassigned".
  - Clear Tiers:  Clear All  Depress twice to clear all
  - Sound:  Stop  Sending Music
  - "Clear" Signal Tower: 5 color-coded options (Red, Amber, Green, Blue, White), each with  Active  Inactive.
- SNMP Clear Section:**
  - E-mail Transmission:  Active  Inactive. Subject: [1.Message] Message: [1.]
  - E-mail Receiver: 8 checkboxes (1-8) labeled "Unassigned".
  - TRAP Transmission:  Active  Inactive
  - SLMP Write Command Transmission Receiver: 4 checkboxes (1-4) labeled "Unassigned".
- RSH Clear Section:**
  - E-mail Transmission:  Active  Inactive. Subject: [1.Message] Message: [1.]
  - E-mail Receiver: 8 checkboxes (1-8) labeled "Unassigned".
  - TRAP Transmission:  Active  Inactive
  - SLMP Write Command Transmission Receiver: 4 checkboxes (1-4) labeled "Unassigned".

At the bottom right, there is a "Set" button highlighted with a red box and a red arrow labeled ⑧.

Figure 4.16.1-1 "Clear" Control Configuration Screen No. 1



Table 4.16.1-2 "Clear" Control Configuration Parameters ("CLEAR" Button)

Item	Contents	Default Value	Input Parameter	Setup Option
"Clear" Switch Function	Select "Active" or "Inactive" for the "Clear" switch.	Active	*	×
E-mail Transmission	Select E-mail Sending as "Active" or "Inactive."	Inactive	*	×
Subject	Select the E-mail title	1.Message	*	×
Message	Select the E-mail text	1:	*	×
E-mail Receiver	Select the recipient to send E-mail to.	Unassigned	*	×
TRAP Transmission	Select the TRAP transmission for "Active" or "Inactive."	Inactive	*	×
SLMP Write Command Transmission Receiver	Select the SLMP write command addressee.	Unassigned	*	×
Clear Tiers	The "Clear" switch can be selected between "Clear All" or "Press twice to clear."	All Clear	*	×
Sound	When "Memory Playback Mode" is selected in the System Setup, the "Sound" field will be shown. The "Clear" operation for the playback channel can be selected between "Stop" or "Sending Music."	Stop	*	×
"Clear" Signal Tower	Select whether the Signal Tower is returned to the normal operation Setup when the "Clear" switch is pressed.	Active	*	×

**Attention**

Refer to "4.16 Normal Mode Setup Screen" for details on how to set up the Signal Tower lighting color during normal operation.  
 Be sure to set up the Signal Tower clear operation settings to "Active" before setting up the Signal Tower color in "4.16 Normal Mode Setup Screen", in order to have the Signal Tower Setup for the normal operation to turn on the Signal Tower color when a clear occurs.

\* The "Setup Option" indication is explained below to indicate in the diagram whether a value input is omissible (a blank is used) or not.

The "x" indicates where is not omissible, or is selected from an item menu.

### 4.16.2. "Clear" Control (SNMP Clear, RSH Clear)

The "Clear" made by an SNMP or RSH command can be set up for transmitting e-mail, TRAP, and SLMP write command in accordance with the conditions that a clear has been made by.

**[Setup Method]**

- ① Select the E-mail Sending Setup for when the "Clear" switch has been pressed.  
 If the E-mail Sending is made "Active", the "E-mail Receiver" is selected for "subject" and "message" after activation.
- ② When using the TRAP transmission, select "Active."

<< The "TRAP Command" this product receives when the TRAP condition occurs >>

OID [1.3.6.1.4.1.20440.4.1.6.4]

Name "trapPatliteClearExecuted"

- ③ When using the SLMP write command transmission, select "SLMP Write Command Transmission Receiver."
- ④ Click the "Set" button to activate the setup.

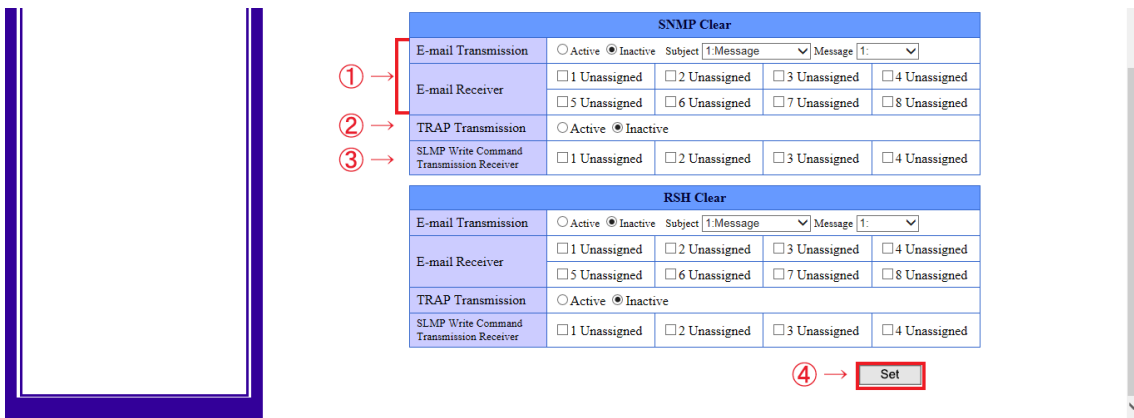

Figure 4.16.2-1 "Clear" Control Configuration Screen No. 2

Table 4.16.2-3 "Clear" Execution Setup Parameters (For SNMP and RSH Clear)

Item	Contents	Default Value	Input Parameter	Setup Option
E-mail Transmission	Select E-mail Sending as "Active" or "Inactive."	Active	*	×
Subject	Select the E-mail title	1.Message	*	×
Message	Select the E-mail text	1:	*	×
E-mail Receiver	Select the recipient to send E-mail to.	Unassigned	*	×
TRAP Transmission	Select the TRAP transmission for "Active" or "Inactive."	Inactive	*	×
SLMP Write Command Transmission Receiver	Select the SLMP write command addressee.	Unassigned	*	×

\* The "Setup Option" indication is explained below to indicate in the diagram whether a value input is omissible (a blank is used) or not.  
The "x" indicates where is not omissible, or is selected from an item menu.

**MEMO** The normal operation setup can be made to turn on one of the colored tiers on the Signal Tower when a clear operation is done.

## 4.17. Normal Mode Settings Screen

Set up the status of the Signal Tower for its normal operating condition. After the setup is complete, use the "Clear" operation for the normal operating condition to be displayed.

### [Setup Method]

- ① Select the status for the Signal Tower at its normal operating condition.
- ② Click the "Set" button to activate the setup.

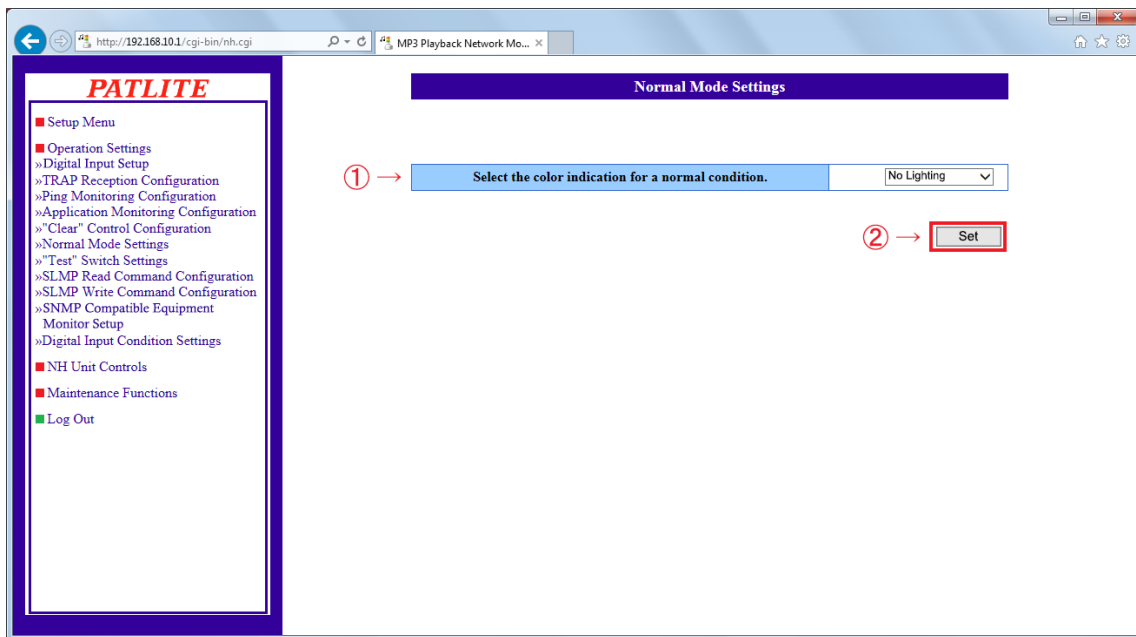

Figure 4.17.0-1 Normal Mode Settings Screen

Table 4.17.0-1 Normal Mode Settings Parameters

Item	Contents	Default Value	Input Parameter	Setup Option
Signal Light	Select from; No Lighting, Red, Yellow, Green, Blue, White lighting to turn on.	No Lighting	*	×

\* The "Setup Option" indication is explained below to indicate in the diagram whether a value input is omissible (a blank is used) or not.  
The "x" indicates where is not omissible, or is selected from an item menu.

**MEMO** Colors other than the set up Signal Tower color are switched off at the time of normal operation.

## 4.18. Test Switch Setup Screen

The following is the setup and operation when the test switch has been pushed.

### [Setup Method]

1. Select the E-mail Sending Setup for when the test switch has been pressed.

If the E-mail Sending is made "Active", the "E-mail Receiver" is selected for "subject" and "message" after activation.

Select "Active" when using the TRAP transmission.

<< The "TRAP Command" this product receives when the TRAP condition occurs >>

OID [1.3.6.1.4.1.20440.4.1.6.8]

Name "trapPatliteTestSwExecuted"

2. Click the "Set" button to activate the setup.

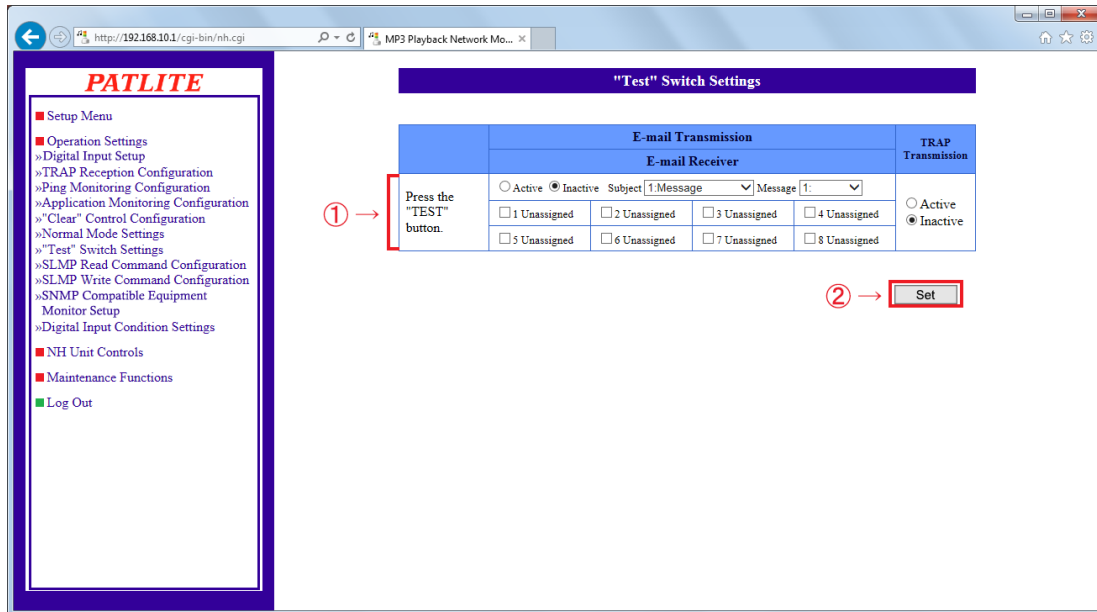

Figure 4.18.0-1 Test Switch Setup Screen

Table 4.18.0-1 Test Switch Setup Parameters

Item	Contents	Default Value	Input Parameter	Setup Option
E-mail Transmission	Select E-mail Sending as "Active" or "Inactive."	Active	*	×
Subject	Select the E-mail title	1.Message	*	×
Message	Select the E-mail text	1:	*	×
E-mail Receiver	Select the recipient to send E-mail to.	Unassigned	*	×
TRAP Transmission	Select the TRAP transmission for "Active" or "Inactive."	Inactive	*	×

\* The "Setup Option" indication is explained below to indicate in the diagram whether a value input is omissible (a blank is used) or not.

The "x" indicates where is not omissible, or is selected from an item menu.

## 4.19. SLMP Read Command Configuration Screen

Set up the SLMP read command transmission. When the data received from the SLMP command transmission object equipment is compared and the compared data agrees on conditions set up, the operation is carried out. Moreover, the operation for receiving error data can also be set up.

### 4.19.1. SLMP Read Command Setup Screen

When there is an SLMP read command transmission, the operation for when there is a condition agreement can also be set up. (The Setup Screen should show the following page)

#### [Setup Method]

- ① . Select from screen number 1 to 16 to setup an SLMP read command transmission.
- ② . Enter the monitoring object device name.
- ③ . Enter the connection destination address.
- ④ . Enter the connection destination port (0-65535).
- ⑤ . Enter the designated sender port (1025-65535).
- ⑥ . Select the protocol (TCP/UDP) to be used.
- ⑦ . Enter a timeout value of 1 to 10.
- ⑧ . Enter a monitoring object device data acquisition point.
- ⑨ . Set up the conditions to compare with.
- ⑩ . Set up the interval for a command transmission. (Shown in screen number 1.)

<< Operation Setting for Condition Agreement >>

- ⑪ . Set up the operation for this product when conditions agree.
- ⑫ . Select the E-mail Sending Setup for when the conditions agree.  
If the E-mail Sending is made "Active", the "E-mail Addressee" is selected for "subject" and "text" after activation.
- ⑬ . When using the TRAP transmission, select "Active."

<< The "TRAP Command" this product receives when the TRAP condition occurs >>

OID "1.3.6.1.4.1.20440.4.1.6.9"

Name [trapPatliteSLMPAction]

Refer to "4.9 Relay Contact Output Setup Screen" for "Digital Output" when selecting a digital output.

- ⑭ . Select the digital output among "ON", "OFF", and "No Change."
- ⑮ . Click the "Set" button to activate the setup.

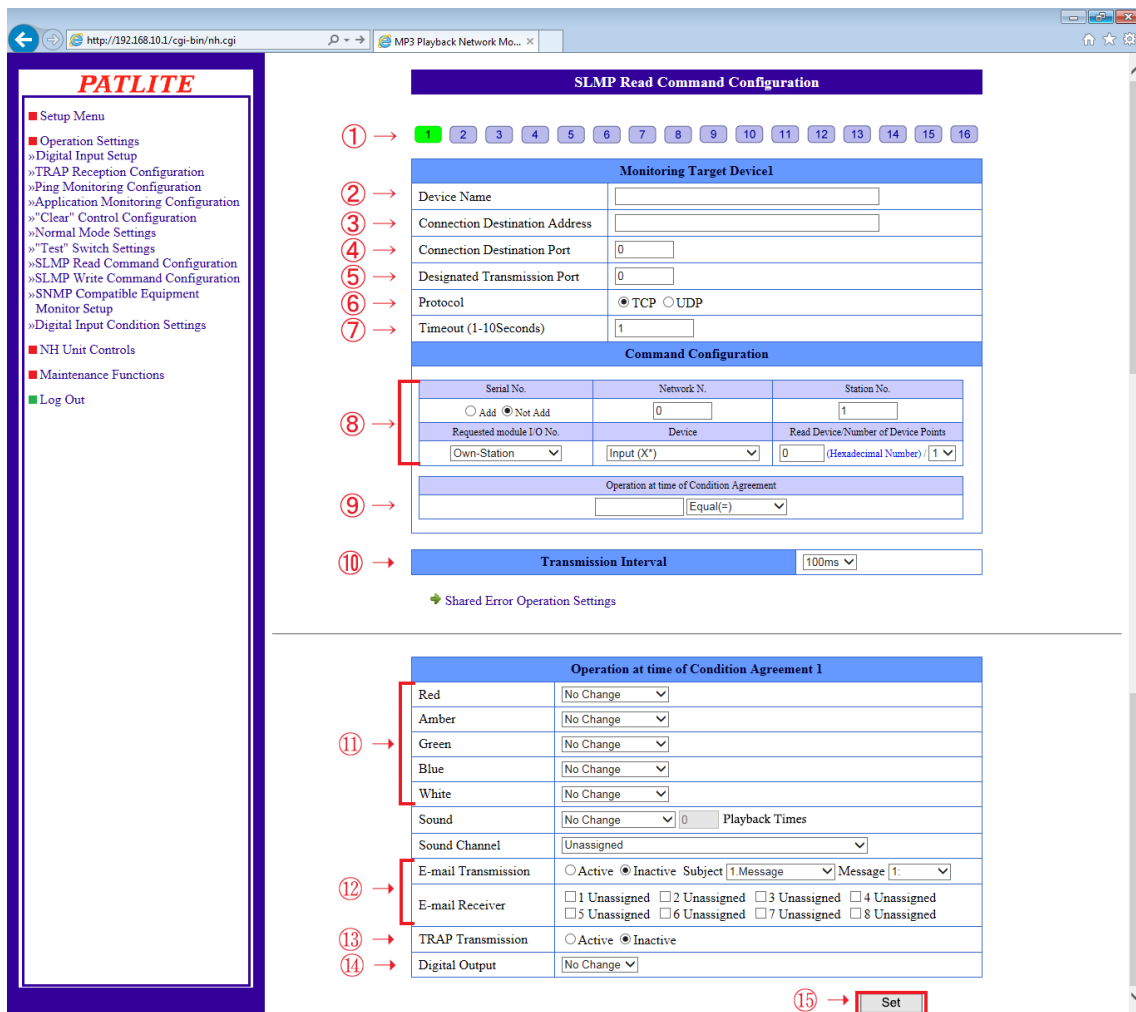

Figure 4.19.1-1 SLMP Read Command Configuration Screen

Table 4.19.1-1 List of Devices which can be set-up

Device	Device Code Binary ASCII	Classification	Range Specification	
Input	9CH (X*)	Bit	16H	For Decimal, it is: 0-65535 For Hexadecimal, it is: 0000-FFFFh  Designate the range number of the device which the unit will access.
Output	9DH (Y*)		16H	
Internal Relay	90H (M*)		10D	
Latch Relay	92H (L*)		10D	
Annunciator	93H (F*)		10D	
Edge Relay	94H (V*)		10D	
Link Relay	A0H (B*)		16H	
Data Register	ABH (D*)	Word	10D	
Link Register	B4H (W*)		16H	
Timer	C2H (TN)		10D	
Addition Timer	C8H (SN)		10D	
Counter	C5H (CN)	10D		
Special Link Relay	A1H (SB)	Bit	16H	
Special Link Register	B5H (SW)	Word	16H	
Direct Input	A2H (DX)	Bit	16H	
Direct Output	A3H (DY)		16H	
Index Register	CCH (Z*)	Word	10D	

Table 4.19.1–2 SLMP Read Command Configuration Parameters

Item	Contents	Default Value	Input Parameter	Setup Option
Device Name	Enter the name of the Command Transmission object.	Blank	Full or half-size (excluding the half-width apostrophe """): Max.: 31 Characters	○
Connection Destination Address	Enter the registration address for the Command Transmission object.	Blank	Enter in the format of an IP Address and host name with a maximum of 63 characters.	×
Connection Destination Port	Enter the connection port for the Command Transmission object.	0	Half-width digit 0-65535	×
Designated Transmission Port	Enter the designated transmission port for when sending the Command Transmission. If the setting is 0, the designated transmission port selects an arbitrary value.	0	Half-width digit 0 1025-65535	×
Protocol	Set up the protocol to be used.	TCP	TCP/UDP	×
Timeout	Enter a duration which allows a time limit for a timeout to wait until it receives a response.	1	1-10 sec.	×
Serial No.	Enter the serial number if necessary.	Not Added	Added/Not Added	×
Network No.	Enter the network number for the access location.	0	00: Own-Station 01-EFH: Other Stations	×
Station No.	Enter the access location station number.	1	FFH: Own-Station 01-78H: Code 7DH: Appointed Station 7EH: Current Station	×
Request module I/O No.	Enter the access CPU module.	Own-Station	*	×
Device	Select the type of device to read.	Input (x *)	* Refer to "Table 4.19.1–1"	×
Read Device	Enter the number for the first device to read. Enter in accordance to the form currently displayed.	0	* Refer to "Table 4.19.1–1"	×
Number of Device points	The number of devices to read is selected.	1	1/2	
Conditions (Value)	It is entered whether it operates, when the value (Reply Data) of the acquired device is which value. Enter with 16 bit numbers.	Blank	It changes with the reading mark value. 1: 0000-FFFFH 2: 0000-FFFFFFFFH	×
Conditions (Conditional Expression)	The acquisitioned device value (response data) compares its set-up conditions and operates the device for that condition.	Equal (=)	"equal" - "not equal" - "equal or greater than" - "equal or less than" - "greater than" - "less than"	×
Transmission Interval	Enter the command transmission interval.	100ms	10ms,50ms,100ms	×
Red/Amber/Green/Blue/White	Select each color among "On", "flashing 1", "flashing 2", "OFF", "No Change".	No Change	*	×
Sound	Sound (When "Repeat Playback" is selected)	No Change	*	×
Sound (When "Repeat Playback" is selected)	Set up Repeat Playback. With a one shot playback at 0 playback times, 1-254 are the number of playback times specified (plus 1 playback time), and 255 playback times becomes an endless playback.	0	Half-width digit 0-255	×
Sound Channel	Select the registered channel.	Unassigned	*	×
E-mail Transmission	Select E-mail Sending as "Active" or "Inactive."	Inactive	*	×
Subject	Select the E-mail title	1.Message	*	×
Message	Select the E-mail text	1:	*	×
E-mail Receiver	Select the recipient to send E-mail to.	Unassigned	*	×
TRAP Transmission	Select the TRAP transmission for "Active" or "Inactive."	Inactive	*	×
Digital Output	The "Digital Output" selection will be displayed by the relay-contact output function. Select from "ON", "OFF", and "No Change" for the digital output.	No Change	*	×

\* The "Setup Option" indication is explained below to indicate in the diagram whether a value input is omissible (a blank is used) or not.

The "x" indicates where is not omissible, or is selected from an item menu.

## 4.19.2. Common Operation Setting Screen for SLMP Error

The operation performed by Acknowledge of a SLMP reading command when an error command is received is set up.

### [Setup Method]

- ① . Select "Shared Error Operation Settings" from the "SLMP read command transmission Setup."

<< Operation Setting when an Error occurs >>

(The Setup Screen should show the following page)

- ② . Perform operation setting of this product at the time of agreeing on conditions.
- ③ . Select the E-mail Sending Setup at the time of agreeing on conditions.  
If the E-mail Sending is made "Active", the "E-mail Receiver" is selected for "subject" and "message" after activation.
- ④ . In cases where it performs TRAP transmission, select "Active."

<< The "TRAP Command" this product receives when the TRAP condition occurs >>

OID [1.3.6.1.4.1.20440.4.1.6.10]

Name "trapPatliteSLMPError"

Referring to "4.9 Relay Contact Output Setup Screen", when selecting a digital output, it is shown in "Digital Output."

- ⑤ . Select operation of a digital output from "ON", "OFF", and "No Change."
- ⑥ . Click the "Set" button to activate the setup.

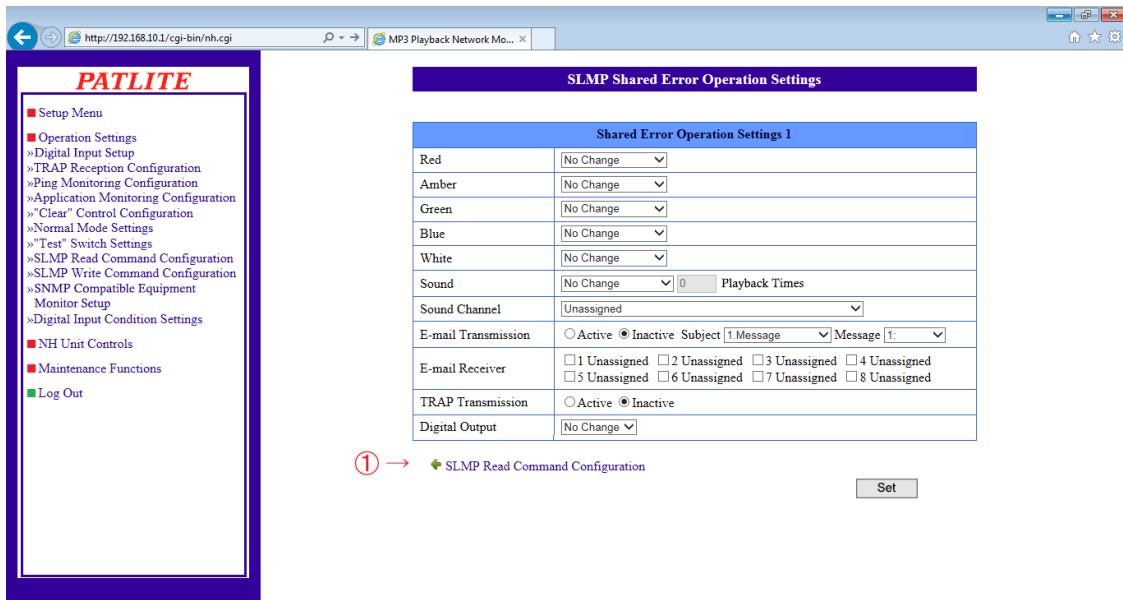

Figure 4.19.2-1 SLMP Read Command Configuration Screen No. 2

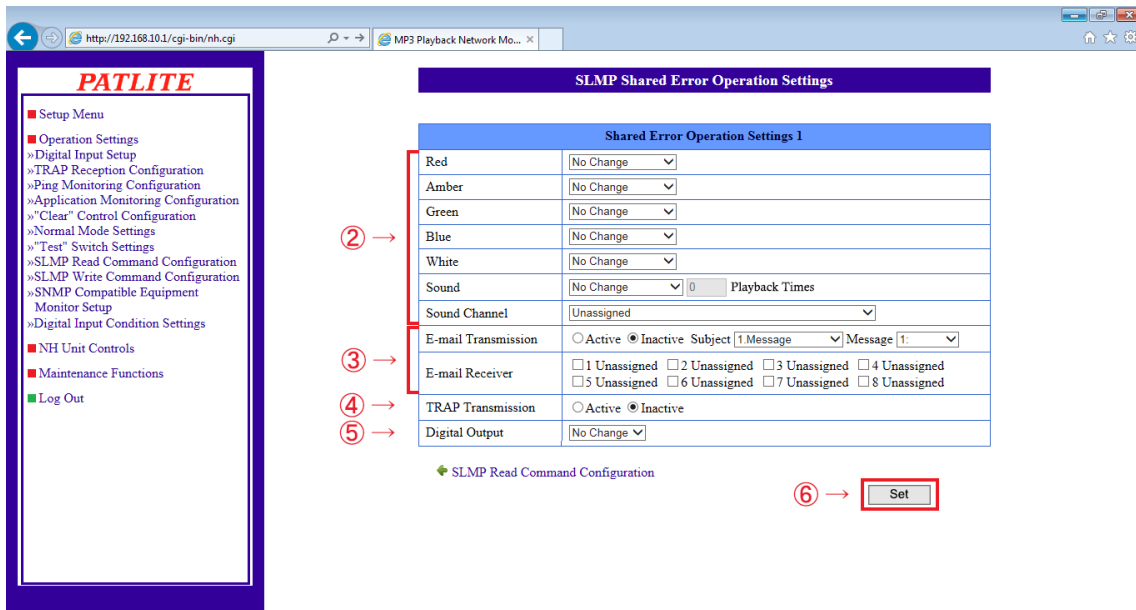

Figure 4.19.2–2 SLMP Shared Error Operation Settings Screen

Table 4.19.2–1 SLMP Shared Error Operation Settings Screen Parameters.

Item	Contents	Default Value	Input Parameter	Setup Option
Red/Amber/Green/Blue/White	Select each color among "On", "flashing 1", "flashing 2", "OFF", "No Change".	No Change	*	×
Sound	Select an audio playback pattern from "Stop", "One-shot Playback", "Repeat Playback", and "No Change."	No Change	*	×
Sound (When "Repeat Playback" is selected)	Set up the Repeat Playback. With a one shot playback at 0 playback times, 1-254 are the number of playback times specified (plus 1 playback time), and 255 playback times becomes an endless playback.	0	Half-width digit 0-255	×
Sound Channel	Select the registered channel.	Unassigned	*	×
E-mail Transmission	Select E-mail Sending as "Active" or "Inactive."	Inactive	*	×
Subject	Select the E-mail title.	1.Message	*	×
Message	Select the E-mail text.	1:	*	×
E-mail Receiver	Select the recipient to send E-mail to.	Unassigned	*	×
TRAP Transmission	Select the TRAP transmission for "Active" or "Inactive."	Inactive	*	×
Digital Output	The "Digital Output" selection will be displayed by the relay-contact output function. Select from "ON", "OFF", and "No Change" for the digital output.	No Change	*	×

\* The "Setup Option" indication is explained below to indicate in the diagram whether a value input is omissible (a blank is used) or not.

The "x" indicates where is not omissible, or is selected from an item menu.



# 4.20. SLMP Write Command Configuration Screen

Set up the SLMP Write Command Transmission settings.

**[Setup Method]**

- ① Select from screen number 1 to 4 to setup an SLMP write command transmission.
- ② Enter the device name of the object to write.
- ③ Enter the connection destination address.
- ④ Enter the connection destination port (0-65535).
- ⑤ Select the protocol (TCP/UDP) to be used.
- ⑥ Enter a data write point for the object to write to the device.
- ⑦ Enter the data to write in.
- ⑧ Click the "Set" button to activate the setup.

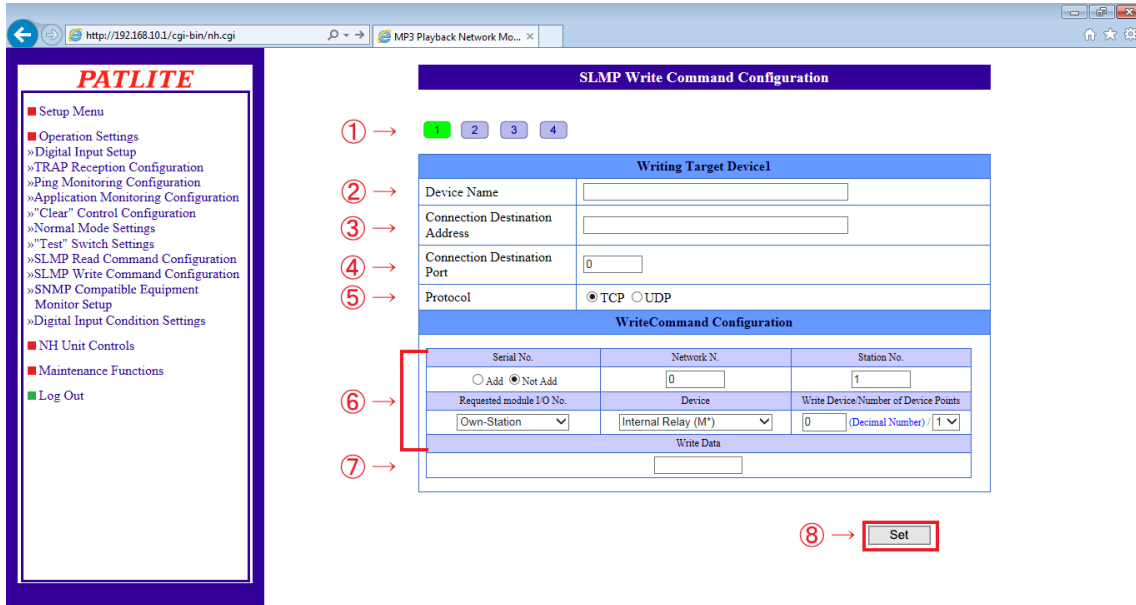

Figure 4.20.0-1 SLMP Write Command Configuration Screen

Table 4.20.0-1 SLMP Write Command Configuration Parameters

Item	Contents	Default Value	Input Parameter	Setup Option
Device Name	Enter the name of the Command Transmission object.	Blank	Full or half-size (excluding the half-width apostrophe """): Max.: 31 Characters	○
Connection Destination Address	Enter the registration address for the Command Transmission object.	Blank	Enter in the format of an IP Address and host name with a maximum of 63 characters.	×
Connection Destination Port	Enter the connection port for the Command Transmission object.	0	Half-width digit 0-65535	×
Protocol	Set up the protocol to be used.	TCP	TCP/UDP	×
Serial No.	Enter the serial number if necessary.	Not Added	Added/Not Added	×
Network No.	Enter the network number for the access location.	0	00: Own-Station 01-EFH: Other Stations	×
Station No.	Enter the access location station number.	1	FFH: Own-Station 01-78H: Code 7DH: Appointed Station 7EH: Current Station	×
Request module I/O No.	Enter the access CPU module.	Own-Station	*	×
Device	Select the type of device to read.	Input (x *)	* Refer to "Table 4.20.0-2"	×
Write Device	Enter the number for the first device to read. Enter in accordance to the form currently displayed.	0	* Refer to "Table 4.20.0-2"	×
Number of Device Points	The number of devices to read is selected.	1	1/2	
Write Data	Enter the data to write in.	Blank	* Refer to "Table 4.20.0-3"	

\* The "Setup Option" indication is explained below to indicate in the diagram whether a value input is omissible (a blank is used) or not.

The "○" indicates where it is omissible.

The "x" indicates where is not omissible, or is selected from an item menu.

Table 4.20.0-2 SLMP Device Write Command Setup

Device	Device Code Binary ASCII	Classification	Range Specification	
Internal Relay	90H(M*)	Bit	10D	For Decimal, it is: 0-65535  For Hexadecimal, it is: 0000-FFFFh
Latch Relay	92H(L*)		10D	
Annunciator	93H(F*)		10D	
Edge Relay	94H(V*)		10D	
Link Relay	A0H(B*)		16H	
Data Register	ABH(D*)	Word	10D	
Link Register	B4H(W*)		16H	
Timer	C2H(TN)		10D	
Addition Timer	C8H(SN)		10D	
Counter	C5H(CN)		10D	
Special Link Relay	A1H(SB)	Bit	16H	
Special Link Register	B5H(SW)	Word	16H	
Index Register	CCH(Z*)	Word	10D	

Table 4.20.0-3 Data Writing Setup Range

Device Classification	Loading Quantity	Data Writing Range
Bit	1 point (1 Bit)	0,1
	2 points (2 Bits)	0,1,2,3
Word	1 point (1 Word)	0-FFFFh
	2 points (2 Words)	0-FFFFFFFFh

**Attention**

Set the limit for the device and data to write to with the device number for access to the unit location.

## 4.21. SNMP Supported Equipment Monitor-Detection Screen 1

Set up the Condition Agreement Detection for the SNMP Supported Equipment Monitor Function. The data acquired from the SNMP Supported Equipment and the conditions set to agree are compared, if the acquired data agrees, a set up can allow agreed conditions to be canceled.

### [Setup Method]

- ① . Select a monitor Setup number (1-20).
- ② . Enter the device names.
- ③ . Enter the connecting destination address.
- ④ . Enter into the "OID" column the monitoring status of the OID for the TRAP which wants to be monitored. Select from "Specified OID Only" or "Under all Specified OID" to monitor the OID. Each parameter is set up to designate a model and value. Select the Judgment conditions. When selecting the "Integer" in a model, select among "Equal", "More Than", or "Less Than" for the conditions. When selecting the "String" in a model, the condition is a fixed value of "Equal."
- ⑤ . Enter the number of seconds for a monitoring interval (0-60). When an abbreviation or 0 is entered, the monitoring function becomes inactive.

<< Operation Setting at a Communication Timeout >>

- ⑥ . When it operates during a condition release when a communication timeout occurs, select "Active."
- ⑦ . Set up the resending count for the SNMP command so it can judge with a communication timeout.

<< Operation Setting for Condition Agreement >>

- ⑧ . Set up the operation for this product when conditions agree. If the E-mail Sending is made "Active", the "E-mail Receiver" is selected for "subject" and "message" after activation.
- ⑩ . When using a TRAP transmission, select "Active."

<< The "TRAP Command" for this product to receive when the TRAP condition occurs >>

OID [1.3.6.1.4.1.20440.4.1.6.13]

Name "trapPatliteSNMPGetMatched"

Referring to "4.9 Relay Contact Output Setup Screen", when selecting a digital output, it is shown in "Digital Output."

- ⑪ . Select the digital output operation among "ON", "OFF", and "No Change."

The screenshot shows the configuration interface for the SNMP Supported Equipment Monitor. The main content area is titled "SNMP Supported Equipment Monitor - Condition Agreement Detection".

**Monitoring Targeted Equipment1**

- ①: Selection buttons 1-20.
- ②: System Name (text input)
- ③: Connection Destination Address (text input)
- ④: Judgment Condition 1 and 2. Each includes:
  - OID (text input)
  - Type: integer (dropdown)
  - Value: 0 (text input)
  - Equal(=) (dropdown)
- ⑤: Monitoring Interval (0-60) Seconds (text input)

**During Communication Timeout Operation Settings1**

- ⑥: Condition Restored:  Active  Inactive
- ⑦: Retry (0~10) (text input)

**Operation at time of Condition Agreement 1**

- ⑧: Red, Amber, Green, Blue, White (color selection dropdowns, all set to "No Change")
- Sound: No Change (dropdown), Playback Times (text input)
- Sound Channel: Unassigned (dropdown)
- ⑨: E-mail Transmission:  Active  Inactive. Subject: 1.Message (dropdown), Message: 1. (dropdown)
- E-mail Receiver: 1-8 Unassigned (checkboxes)
- ⑩: TRAP Transmission:  Active  Inactive
- ⑪: Digital Output: No Change (dropdown)

Figure 4.21.0-1 SNMP Supported Equipment Monitor Setup - Condition Agreement Detection Screen No. 1

<< Operation Setting for Condition Agreement >>

- ⑫ . Set up the operation for this product when conditions are canceled.
- ⑬ . Select an E-mail Sending Setup when conditions are canceled.  
If the E-mail Sending is made "Active", the "E-mail Addressee" is selected for "subject" and "text" after activation.
- ⑭ . Select "Active" when using the TRAP transmission.

<< The "TRAP Command" for this product to receive when the TRAP condition occurs >>

OID [1.3.6.1.4.1.20440.4.1.6.14]

Name "trapPatliteSNMPGetReleased"

Referring to "4.9 Relay Contact Output Setup Screen", when selecting a digital output, it is shown in "Digital Output."

- ⑮ . Select the digital output operation among "ON", "OFF", and "No Change."
- ⑯ . Select the monitoring condition to the setup to return to monitoring when a condition cancellation operation occurs.
- ⑰ . Click the "Set" button to activate the setup.

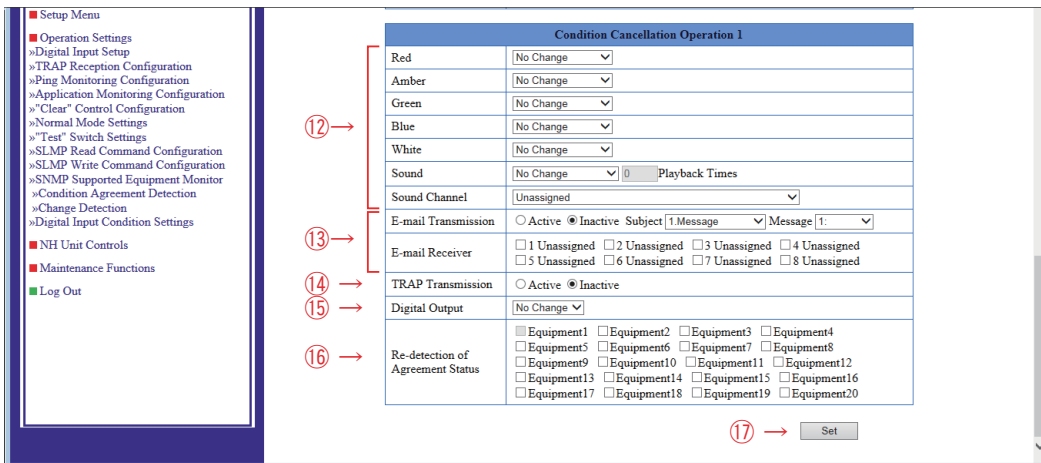

Figure 4.21.0-2 SNMP Supported Equipment Monitor Setup - Condition Agreement Detection Screen No. 2

Table 4.21.0-1 SNMP Supported Equipment Monitor Setup - Condition Agreement Detection Parameters

Item	Contents	Default Value	Input Parameter	Setup Option
System Name	Enter the device names for the monitoring targets.	Blank	Full or half-size (excluding the half-width apostrophe """): Max.: 32 Characters	○
Connection Destination Address	Enter the monitoring target address.	Blank	Characters which can be used for the IP address and host name	×
OID (Judgment Conditions)	Enter the OID to be acquired.	Blank	A number and "." (period): Max. 127 Character	×
Specified OID Only (Judgment Conditions)	Select the OID to be monitored as "Specified OID Only" or "Under all Specified OID"	Specified OID Only	*	×
Type (Judgment Conditions)	Select the OID type to be acquired as "Integer" or "String."	Integer	*	○
Value (Judgment Conditions)	Enter the OID value to be acquired.	0	Number (0-2147483647) or half-width character: Max. 63 Char.	○
Conditions (Judgment Conditions)	When the model is selected as "Integer", the OID "judgment conditions" is to be selected among "equal", "greater than" or "less than." When the model is selected as "String", it set at a fixed condition of "Equal" and cannot be changed.	"Equal"	*	×
Monitoring Interval	Enter the period to transmit the SNMP command. When an abbreviation or 0 is entered, the monitoring function becomes inactive.	0	Half-width digits 0-60	×
Condition Restored	"Active" and "Inactive" of the condition release at the time of communication timeout are selected.	Inactive	*	×
Retry	A retry count through an SNMP command can be set up with an arbitrary number from 0 to 10 times can be sent out until it can judge, or a communication timeout occurs.	0	Half-width digits 0-10	×
Red/Amber/Green/Blue/White	Select each color among "On", "flashing 1", "flashing 2", "OFF", "No Change".	No Change	*	×
Sound	Select an audio playback pattern from "Stop", "One-shot Playback", "Repeat Playback", and "No Change."	No Change	*	×
Sound (When "Repeat Playback" is selected)	Set up the Repeat Playback. With a one shot playback at 0 playback times, 1-254 are the number of playback times specified (plus 1 playback time), and 255 playback times becomes an endless playback.	0	Half-width digits 0-255	×
Sound Channel	Select the registered channel.	Unassigned	*	×
E-mail Transmission	Select E-mail Sending as "Active" or "Inactive."	Inactive	*	×
Subject	Select the E-mail title.	1.Message	*	×
Message	Select the E-mail text	1:	*	×
E-mail Receiver	Select the recipient to send E-mail to.	Unassigned	*	×
TRAP Transmission	Select the TRAP transmission for "Active" or "Inactive."	Inactive	*	×
Digital Output	If a "Digital Output" select is made by a relay-contact output function, it will select from "ON", "OFF", and "No Change" as a display digital output. The digital output can be selected among; "ON", "OFF", and "No Change".	No Change	*	×
Re-detection Agreement Status	When there is an agreement status re-detection condition cancellation operation, select the monitor setup to return to a monitoring condition.	Unassigned	*	×

\* The "Setup Option" indication is explained below to indicate in the diagram whether a value input is omissible (a blank is used) or not.

The "O" indicates where it is omissible.

The "x" indicates where is not omissible, or is selected from an item menu.

**MEMO**

- When both judgment conditions are set up, it will operate if both conditions agrees on.
- In order to return to the monitoring condition from a condition agreement status, go to the Web setup tool on the "SNMP Compatible Equipment Monitor Setup-Condition Agreement Detection" page and push "Set" The equipment monitor setup status corresponding to all the SNMPs turns into a monitoring condition.

## 4.22. SNMP Supported Equipment Monitor-Detection Screen 2

Set up the Condition Agreement Detection for the SNMP Supported Equipment Monitor Function. The value acquired from the SNMP Supported Equipment is compared with the value acquired just before that, and if the value has changed, the set up operation will be carried out.

### [Setup Method]

- ① . Select a monitor Setup number (1-5).
- ② . Enter the device names.
- ③ . Enter the connecting destination address.
- ④ . Enter in the "Judgment Conditions" column the periodically acquired OID.
- ⑤ . Enter the number of seconds of a monitoring interval (0-60). When an abbreviation or 0 is entered, the monitoring function becomes inactive.

<< Operation Setting during Change Detection >>

- ⑥ . Set up the operation for this product when variations are detected.
- ⑦ . Select the E-mail Sending Setup for when a change is detected.  
If the E-mail Sending is made "Active", the "E-mail Receiver" is selected for "subject" and "message" after activation.
- ⑧ . When using the TRAP transmission, select "Active."

<< The "TRAP Command" for this product to receive when the TRAP condition occurs >>

OID [1.3.6.1.4.1.20440.4.1.6.16]

Name "trapPatliteSNMPGetChange"

Referring to "4.9 Relay Contact Output Setup Screen", when selecting a digital output, it is shown in "Digital Output."

- ⑨ . Select operation of the digital output between "ON", "OFF", and "No Change."
- ⑩ . Click the "Set" button to activate the setup.

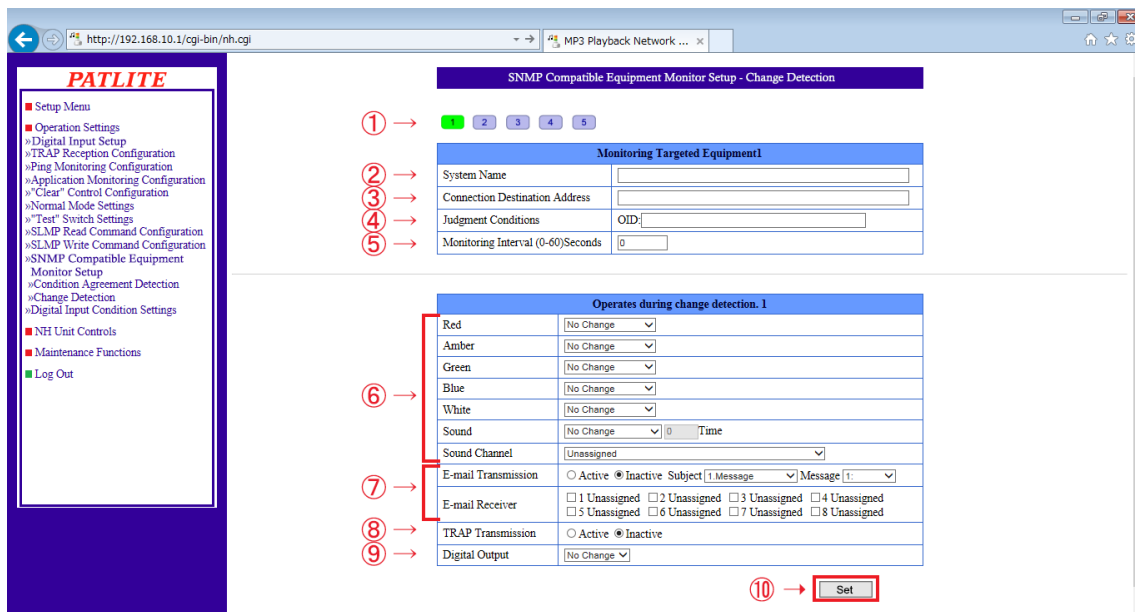

Figure 4.22.0-1 SNMP Supported Equipment Monitor - Change Detection Screen

Table 4.22.0-1 SNMP Supported Equipment Monitor Setup - Change Detection Parameters

Item	Contents	Default Value	Input Parameter	Setup Option
System Name	Enter the device names for the monitoring targets.	Blank	full size or half size other than a half-width apostrophe ""', Max.: 31 Char.	○
Connection Destination Address	Enter the monitoring target address.	Blank	Characters which can be used for the IP address and host name	×
OID (Judgment Conditions)	Enter the OID to be acquired.	Blank	A number and "." (period): Max. 127 Char.	×
Monitoring Interval	Enter the period to transmit the SNMP command. When 0 is entered, the monitoring function becomes inactive	0	Half-width digit 0-60	×
Red/Amber/Green/Blue/White	Select from "On", "flashing 1", "flashing 2", "Off", "No Change" for each Signal Tower color.	No Change	*	×
Sound	Select an audio playback pattern from "Stop", "One-shot Playback", "Repeat Playback", and "No Change."	No Change	*	×
Sound (When "Repeat Playback" is selected)	Set up the Repeat Playback. With a one shot playback at 0 playback times, 1-254 are the number of playback times specified (plus 1 playback time), and 255 playback times becomes an endless playback.	0	Half-width digit 0-255	×
Sound Channel	Select the registered channel.	Unassigned	*	×
E-mail Transmission	Select E-mail Sending as "Active" or "Inactive."	Inactive	*	×
Subject	Select the E-mail title.	1.Message	*	×
Message	Select the E-mail text.	1:	*	×
E-mail Receiver	Select the recipient to send E-mail to.	Unassigned	*	×
TRAP Transmission	Select the TRAP transmission for "Active" or "Inactive."	Inactive	*	×
Digital Output	If a "Digital Output" select is made by a relay-contact output function, it will select from "ON", "OFF", and "No Change" as a display digital output.	No Change	*	×

\* The "Setup Option" indication is explained below to indicate in the diagram whether a value input is omissible (a blank is used) or not.

The "○" indicates where it is omissible.

The "×" indicates where is not omissible, or is selected from an item menu.

## 4.23. Digital Input Condition Settings Screen

Set up the Digital Input conditions.

### [Setup Method]

- ① Select a number (1-4) for the condition setup
- ② Select a condition from the pull down menu (digital inputs 1-4).  
Enter a measurement time (0-3600).  
It does not operate when set to 0
- ③ Select the operation at the time of a clear switch depression from "Active" - "Inactive."
- ④ Detect the condition agreement for the and afterwards time, or select from "Active" - "Inactive."
- ⑤ Set up operation when conditions agree.
- ⑥ Select the E-mail Sending Setup for when there is a condition agreement.  
If the E-mail Sending is made "Active", the "E-mail Receiver" is selected for "subject" and "message" after activation.
- ⑦ Select "Active" when using the TRAP transmission.

<< The "TRAP Command" for this product to receive when the TRAP condition occurs >>

OID [1.3.6.1.4.1.20440.4.1.6.15.1] - [1.3.6.1.4.1.20440.4.1.6.15.4]

Name "diConditionMatch" to "diConditionMatch4"

Referring to "4.9 Relay Contact Output Setup Screen", when selecting a digital output, it is shown in "Digital Output."

- ⑧ Select an operation for the digital output among "ON", "OFF", and "No Change."
- ⑨ Click the "Set" button to activate the setup.

**PATLITE**

■ Setup Menu

- Operation Settings
  - » Digital Input Setup
  - » TRAP Reception Configuration
  - » Ping Monitoring Configuration
  - » Application Monitoring Configuration
  - » "Clear" Control Configuration
  - » Normal Mode Settings
  - » "Test" Switch Settings
  - » SLMP Read Command Configuration
  - » SLMP Write Command Configuration
  - » SNMP Compatible Equipment Monitor Setup
  - » Condition Agreement Detection
  - » Change Detection
  - » Digital Input Condition Settings
- NH Unit Controls
- Maintenance Functions
- Log Out

**Digital Input Condition Settings**

① → 1 2 3 4

**Conditions 1**

② → Input Time (0-3600) [None] 0 Seconds Duration ON

**Operates when the "Clear" switch is pressed. 1**

③ → "Clear" Condition  Active  Inactive

**After-agreement Operation 1**

④ → Re-detection  Active  Inactive

**Operation at time of Condition Agreement 1**

Red	No Change
Amber	No Change
Green	No Change
Blue	No Change
White	No Change
Sound	No Change 0 Playback Times
Sound Channel	Unassigned

⑤ →

⑥ → E-mail Transmission  Active  Inactive Subject [1.Message] Message [1: ]

E-mail Receiver  1 Unassigned  2 Unassigned  3 Unassigned  4 Unassigned  
 5 Unassigned  6 Unassigned  7 Unassigned  8 Unassigned

⑦ → TRAP Transmission  Active  Inactive

⑧ → Digital Output No Change

⑨ → Set

Figure 4.23.0-1 Digital Input Condition Settings Screen



Table 4.23.0–1 Digital Input Condition Settings Parameters

Item	Contents	Default Value	Input Parameter	Setup Option
Digital input detection (Detection at Input)	Select the digital input (ports 1-4) to detect from the pull down menu. It will not operate if "None" is selected.	None	*	×
Input Time	Enter the time to measure. It does not operate when set to 0.	0	Half-width digit 0-3600	×
"Clear" Condition	Based on the "Clear" condition, a clear will occur when the "Clear" switch is pressed. When set to "Active", an initialization will occur when the "Clear" switch is pressed. When set to "Inactive", there is no change, even if the "Clear" switch is pressed.	Inactive	*	×
Re-detection	Re-detection can be set up. When set to "Active", it operates upon an agreement in the detection condition. When set to "Inactive", after it's been set up, only at the beginning will it agree during a detection condition and operate when it agrees in a detection condition, but after that, it will not operate.	Inactive	*	×
Red/Amber/Green/Blue/White	Select from "On", "flashing 1", "flashing 2", "Off", "No Change" for each Signal Tower color.	No Change	*	×
Sound	Select an audio playback pattern from "Stop", "One-shot Playback", "Repeat Playback", and "No Change."	No Change	*	×
Sound (When "Repeat Playback" is selected)	Repeat Playback is set up. With a one shot playback at 0 playback times, 1-254 are the number of playback times specified (plus 1 playback time), and 255 playback times becomes an endless playback.	0	Half-width digit 0-255	×
Sound Channel	Select the registered channel.	Unassigned	*	×
E-mail Transmission	Select E-mail Sending as "Active" or "Inactive."	Inactive	*	×
Subject	Select the E-mail title.	1.Message	*	×
Message	Select the E-mail text	1:	*	×
E-mail Receiver	Select the recipient to send E-mail to.	Unassigned	*	×
TRAP Transmission	Select the TRAP transmission for "Active" or "Inactive."	Inactive	*	×
Digital Output	The "Digital Output" selection will be displayed by the relay-contact output function. Select from "ON", "OFF", and "No Change" for the digital output.	No Change	*	×

\* The "Setup Option" indication is explained below to indicate in the diagram whether a value input is omissible (a blank is used) or not.

The "x" indicates where is not omissible, or is selected from an item menu.

## 4.24. Signal Tower Output Control Screen

Verify the current operating status, and output a condition status for the Signal Tower.

### [Setup Method]

- ① . Check the current operating state of the Signal Tower.
- ② . Select operation of Signal-Tower each color.
- ③ . Click the "Execute Output" button.

The Signal Tower operates as the contents set up by ② .

- ④ . If the "Execute Clear" button is clicked, it will return to the "Normal Mode" status.

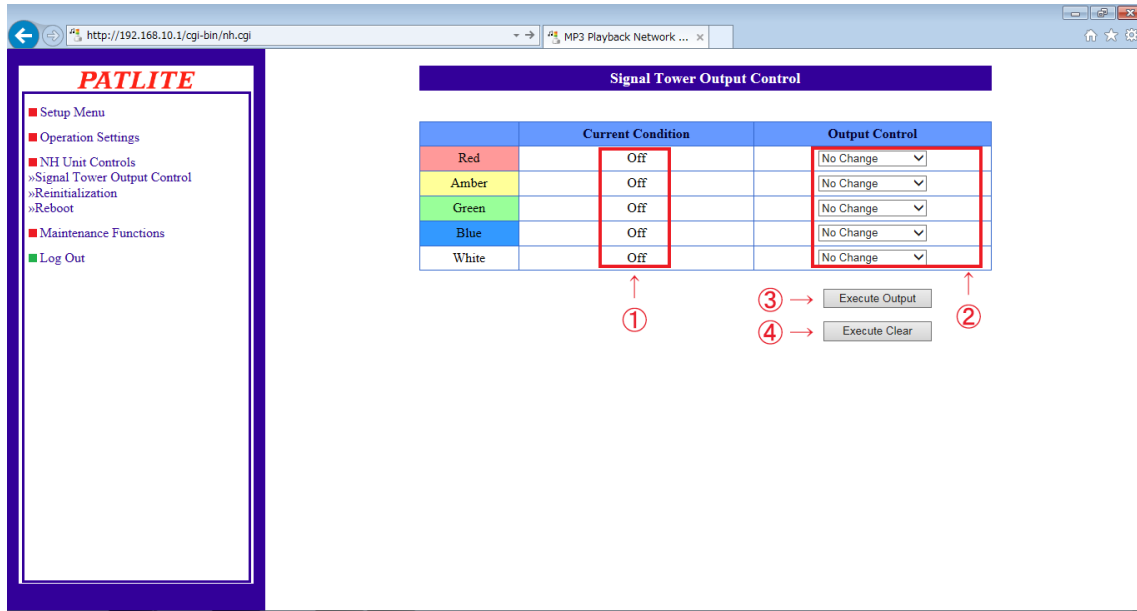

Figure 4.24.0-1 Signal Tower Output Control Screen

Table 4.24.0-1 Signal Tower Output Control Parameters

Item	Contents	Default Value	Input Parameter	Setup Option
Red	Select from "On", "Flashing Pattern 1", "Flashing Pattern 2", "Off", "No Change".	No Change	*	×
Amber	Select from "On", "Flashing Pattern 1", "Flashing Pattern 2", "Off", "No Change".	No Change	*	×
Green	Select from "On", "Flashing Pattern 1", "Flashing Pattern 2", "Off", "No Change".	No Change	*	×
Blue	Select from "On", "Flashing Pattern 1", "Flashing Pattern 2", "Off", "No Change".	No Change	*	×
White	Select from "On", "Flashing Pattern 1", "Flashing Pattern 2", "Off", "No Change".	No Change	*	×

\* The "Setup Option" indication is explained below to indicate in the diagram whether a value input is omissible (a blank is used) or not.

The "x" indicates where is not omissible, or is selected from an item menu.

## 4.25. Reinitialization Screen

The setup parameters can be reset to their default values by initializing this product. The setup can be selected whether to initialize in accordance with the network setup and channels registered with the Playlist Package at the time of initialization.

### MEMO

"Network Setup" refers to the "IP address for this product, Net Mask, Default Gateway, DNS server address and Host Name" parameters in the System Setup Screen.

### [Setup Method]

- ① . When adding initialization to the network Setup, a check is put into the "Network also reinitializes."
- ② . When the registered channels (Channel 01- 30) from the Playlist Package is to be initialized, put a check into the "Playlist data also initialized" box.
- ③ . Click the "Execute Reinitialize" button.

When either (1), (2) or both boxes are not checked before initialization, Channels 01- 30 registered from the Playlist Package and the network setup is not changed, but only the other setups are initialized.

### Attention

- If the network setup is also initialized, since the IP address will return to its factory default value, the network has to be setup again.
- By executing an initialization, the MP3 data registered from the Web Setup tool is erased.

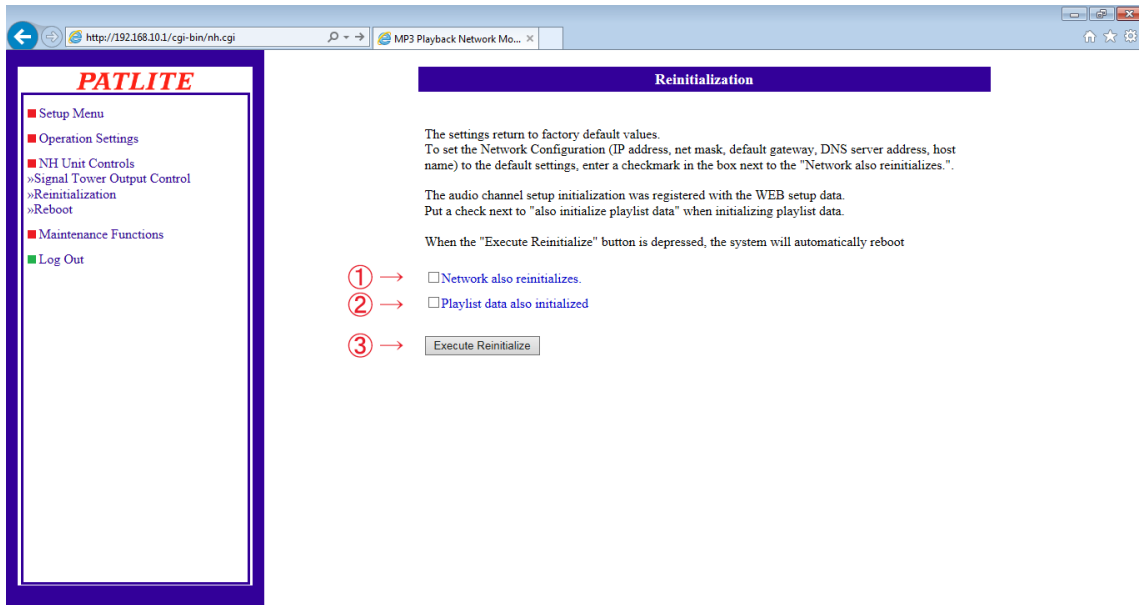

Figure 4.25.0–1 Reinitialization Screen

## 4.26. Reboot Screen

This product can be rebooted just by clicking the "Reboot" button.

- ① . Once the "reboot" button is clicked, a new screen (Refer to "Figure 4.26.0-1" for reference), like the figure below will display a message indicating it is rebooting.
- ② . Click "To Login Screen" on the new screen to log back in. (Refer to "Figure 4.26.0-2" for reference)

**MEMO**

If a log is required, be sure to download an event log in advance.

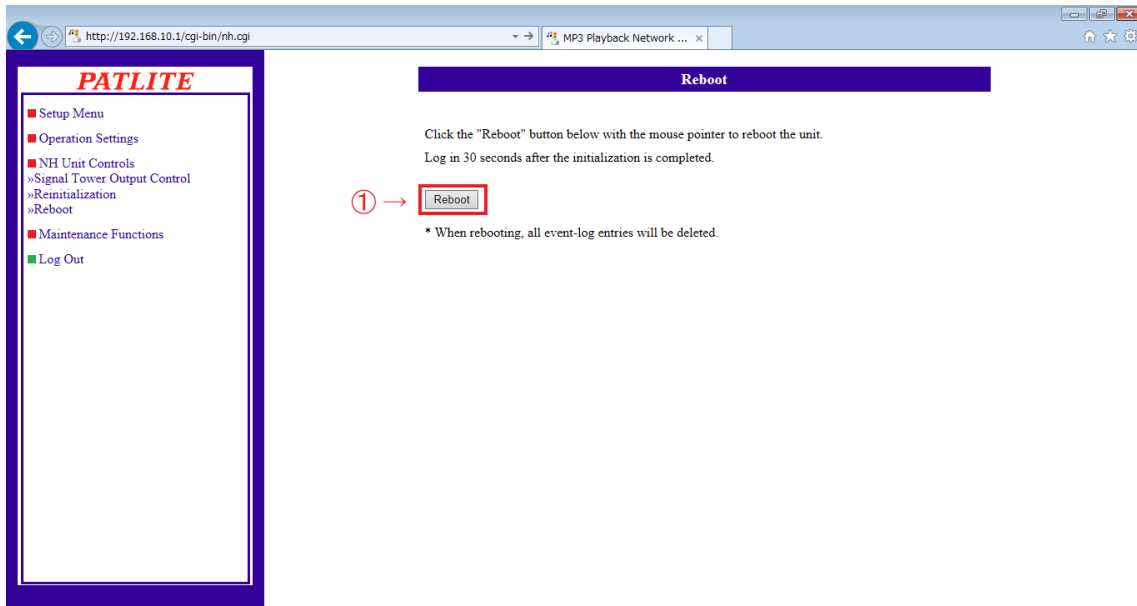

Figure 4.26.0-1 Reboot Screen

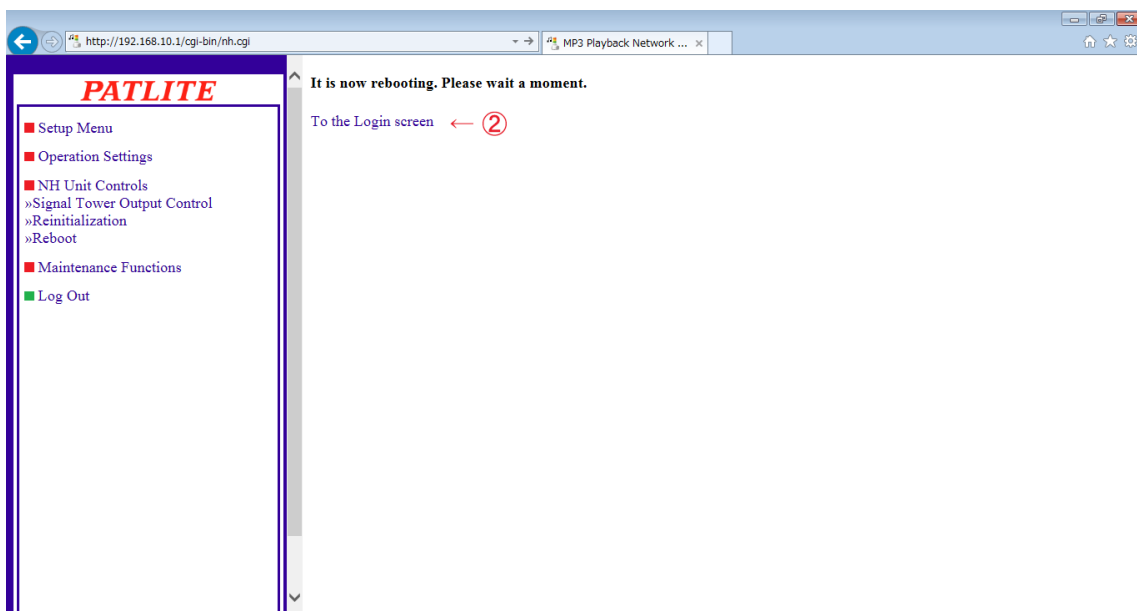

Figure 4.26.0-2 Screen after executing a "Reboot"

## 4.27. Event Log Screen

Events from this product are logged and is shown in the event log.  
By clicking the "Event Log Download", an event log file can be downloaded.  
A maximum of 255 logged events are acquirable.

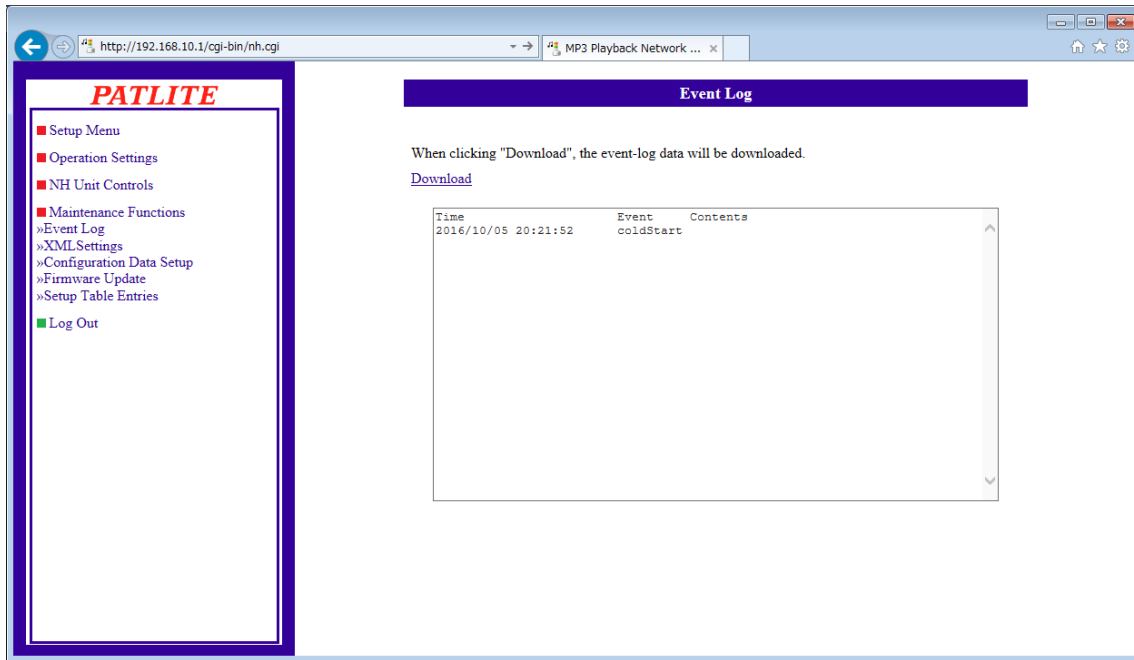

Figure 4.27.0–1 Event Log Screen

### Attention

The event log data will be erased if either of the following operations are executed.

- Turn the power source OFF.
- Reinitialize this product from the initialization screen.
- Reboot this product.
- Press the "Reset" switch.

## 4.28.XML Settings Screen

The following is the setup and download for the XML data output from this product.

### [Setup Method]

- ① . When using the XML data output, select "Active." Select "Inactive", when not exporting an XML data output.
- ② . Select the authentication method when designating and accessing the URL directly and acquiring data with "Login Authentication" or "No Authentication."
- ③ . Clicking the "Download" button will download the XML data.  
(It will only be downloadable when the "XML file output" is set as "Active")
- ④ . Click the "Set" button to activate the setup.

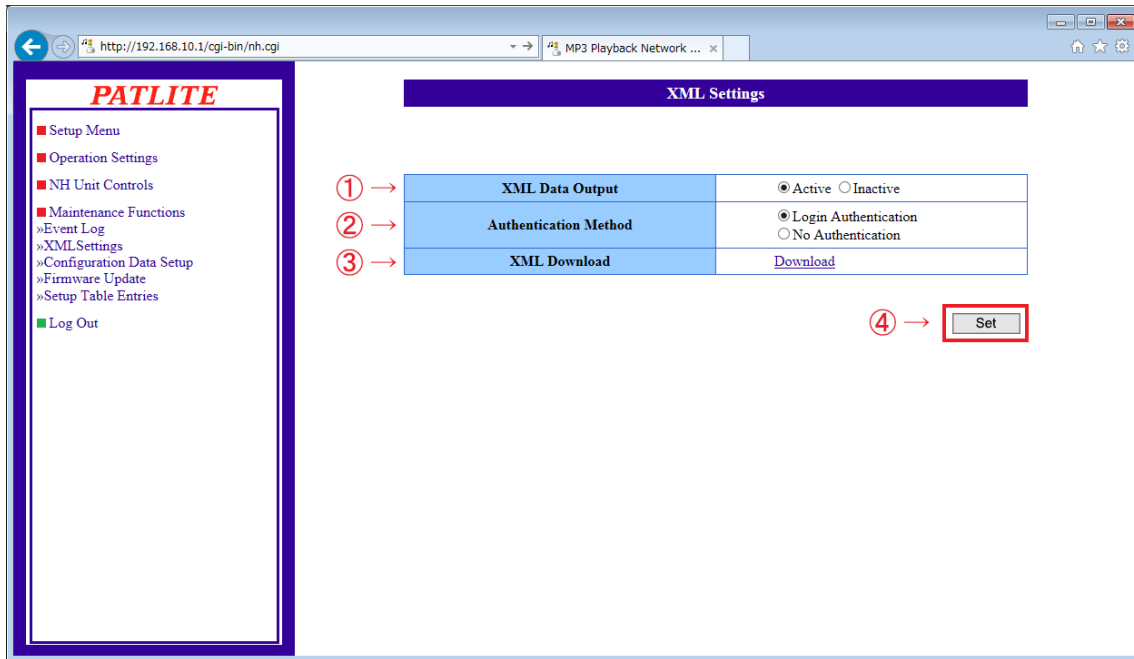

Figure 4.28.0-1 XML Settings Screen

#### Attention

If the authentication method is set for "No Authentication", the XML data can be acquired without logging in for authentication of a Web setup tool. If set to "Login Authentication", login authentication of the Web setup tool is necessary when acquiring an XML file.

#### MEMO

An XML file is downloadable only when the XML file output is set as "Active."

Table 4.28.2-2 XML Data Settings Parameters

Item	Contents	Default Value	Input Parameter	Setup Option
XML Data Output	Set either "Active" or "Inactive" for the XML data output function.	Inactive	*	×
Authentication Method	Select the authentication, when designating directly with a URL and acquisitioning an XML data output.	Login Authentication	*	×
XML Download	XML data is downloaded.	*	*	×

\* The "Setup Option" indication is explained below to indicate in the diagram whether a value input is omissible (a blank is used) or not.

The "x" indicates where is not omissible, or is selected from an item menu.

## 4.29. Configuration Data Setup Screen

The setup parameters for this product is read and can be saved as configuration data on the PC. Moreover, configuration data which was read from the product can be selected to be written in.

### Attention

Configuration data consists of operation setup information which is registered in the Main Unit. The network setup and password information is not included in the configuration data.

### [Setup Method]

<< Reading Configuration Data >>

- ① . The "Read" button is clicked for the configuration data to be saved on the PC.

<< Writing Configuration Data >>

- ② . Click the "Browse" button to select the configuration data to write into this product.
- ③ . Click the "Write" button to start the uploading of the configuration data. After the configuration data is uploaded, this product will automatically reboot.

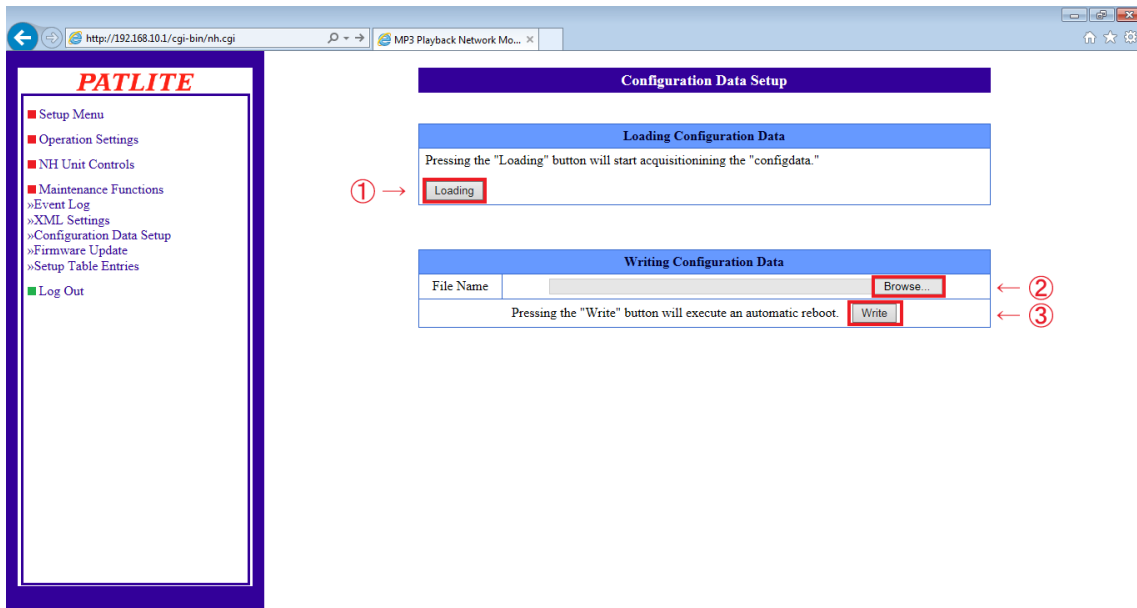

Figure 4.29.0-1 Configuration Data Setup Screen

## 4.30. Firmware Update Screen

The firmware for this product can be updated.

### [Setup Method]

- ① Click the "Browse" button to select the firmware to be written into this product.
- ② Clicking the "update" button will start the firmware update.

The update may take up to 5 minutes.

When the update is complete, the message "It is now rebooting. Please wait a moment." will play and the product will reboot automatically.

### Attention

- Do not disconnect the power cable or LAN cable during the update. Possible cause of failure may occur.
- Be sure to verify the object model and firmware version before executing an update. If an object is not selected when the firmware is to be updated, it will result in a cause of failure to this product.

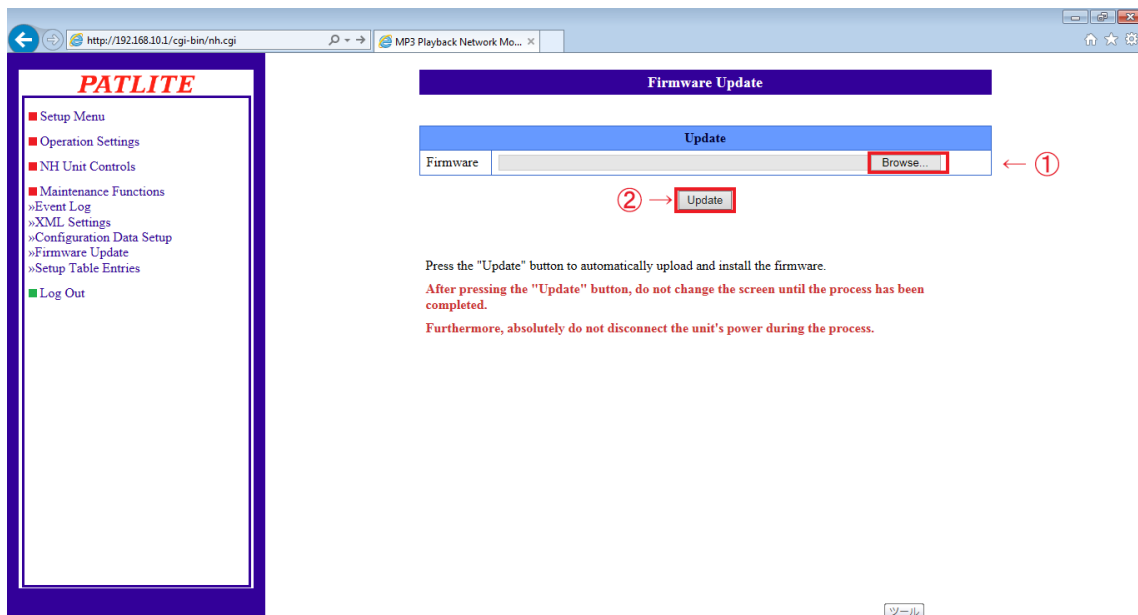

Figure 4.30.0-1 Firmware Update Screen



# 4.31. Setup Table Entries Screen

The "Setup Table Entries screen" lists and displays the contents of settings, operation functions, such as application monitor abnormality and abnormality restoration; Ping monitor abnormality and abnormality restoration; Trap reception setup operations, as well as the firmware version of this product. The solid circle indicates when the E-mail Sending and TRAP transmission are activated. The "-" displays where items selected are not changed.

The screenshot shows the PATLITE Setup Table Entries screen. The browser address bar shows 'http://192.168.101/cgi-bin/nh.cgi'. The page title is 'Setup Table Entries'. The firmware version is 'Ver 1.06'. The screen contains several tables for configuring monitoring and recovery settings.

**Output Control Setting for TRAP Reception**

Name	Red	Amber	Green	Blue	White	Sound	E-mail Transmission	TRAP Transmission
1:	-	-	-	-	-	-		
2:	-	-	-	-	-	-		
3:	-	-	-	-	-	-		
4:	-	-	-	-	-	-		
5:	-	-	-	-	-	-		
6:	-	-	-	-	-	-		
7:	-	-	-	-	-	-		
8:	-	-	-	-	-	-		
9:	-	-	-	-	-	-		
10:	-	-	-	-	-	-		
11:	-	-	-	-	-	-		
12:	-	-	-	-	-	-		
13:	-	-	-	-	-	-		
14:	-	-	-	-	-	-		
15:	-	-	-	-	-	-		
16:	-	-	-	-	-	-		

**Ping Monitoring Abnormality Operation Setting**

Name	Red	Amber	Green	Blue	White	Sound	E-mail Transmission	TRAP Transmission
1:	-	-	-	-	-	-		
2:	-	-	-	-	-	-		
3:	-	-	-	-	-	-		
4:	-	-	-	-	-	-		
5:	-	-	-	-	-	-		
6:	-	-	-	-	-	-		
7:	-	-	-	-	-	-		
8:	-	-	-	-	-	-		
9:	-	-	-	-	-	-		
10:	-	-	-	-	-	-		
11:	-	-	-	-	-	-		
12:	-	-	-	-	-	-		
13:	-	-	-	-	-	-		
14:	-	-	-	-	-	-		
15:	-	-	-	-	-	-		
16:	-	-	-	-	-	-		
17:	-	-	-	-	-	-		
18:	-	-	-	-	-	-		
19:	-	-	-	-	-	-		
20:	-	-	-	-	-	-		
21:	-	-	-	-	-	-		
22:	-	-	-	-	-	-		
23:	-	-	-	-	-	-		
24:	-	-	-	-	-	-		

**Ping Monitoring Abnormality Recovery Operation Setting**

Name	Red	Amber	Green	Blue	White	Sound	E-mail Transmission	TRAP Transmission
1:	-	-	-	-	-	-		
2:	-	-	-	-	-	-		
3:	-	-	-	-	-	-		
4:	-	-	-	-	-	-		
5:	-	-	-	-	-	-		
6:	-	-	-	-	-	-		
7:	-	-	-	-	-	-		
8:	-	-	-	-	-	-		
9:	-	-	-	-	-	-		
10:	-	-	-	-	-	-		
11:	-	-	-	-	-	-		
12:	-	-	-	-	-	-		
13:	-	-	-	-	-	-		
14:	-	-	-	-	-	-		
15:	-	-	-	-	-	-		
16:	-	-	-	-	-	-		
17:	-	-	-	-	-	-		
18:	-	-	-	-	-	-		
19:	-	-	-	-	-	-		
20:	-	-	-	-	-	-		
21:	-	-	-	-	-	-		
22:	-	-	-	-	-	-		
23:	-	-	-	-	-	-		
24:	-	-	-	-	-	-		

**Application Monitoring Abnormality Operation Setting**

Name	Red	Amber	Green	Blue	White	Sound	E-mail Transmission	TRAP Transmission
1:	-	-	-	-	-	-		
2:	-	-	-	-	-	-		
3:	-	-	-	-	-	-		
4:	-	-	-	-	-	-		

**Application Monitoring Abnormality Recovery Operation Setting**

Name	Red	Amber	Green	Blue	White	Sound	E-mail Transmission	TRAP Transmission
1:	-	-	-	-	-	-		
2:	-	-	-	-	-	-		
3:	-	-	-	-	-	-		
4:	-	-	-	-	-	-		

When the "No Change" is set, a hyphen ("-") will be displayed.

Figure 4.31.0-1 Setup Table Entries Screen

## 4.32. Logout Screen

If the "Logout" at the bottom of the menu is clicked, it will log out of the web setup tool.

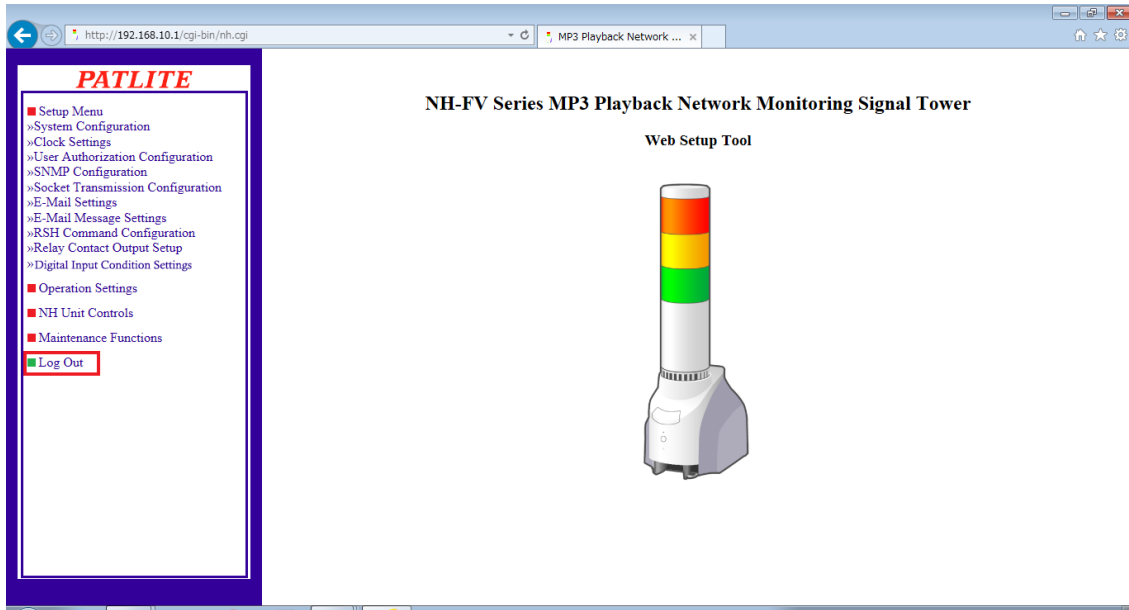

Figure 4.32.0-1 Logout Button Position

### Attention

- If there is no activity for 10 minutes or more during login, it logs out automatically. When that occurs, please log in again.
- This product does not support double log-ins. This prevents being able to access from two or more places. It is recommended to log out after completing a setup parameter.

# 5. MIB

With this product, there is an exclusive MIB (Management Information Base) for the NH Series, and the monitor controls can be operated by the SNMP manager, etc.

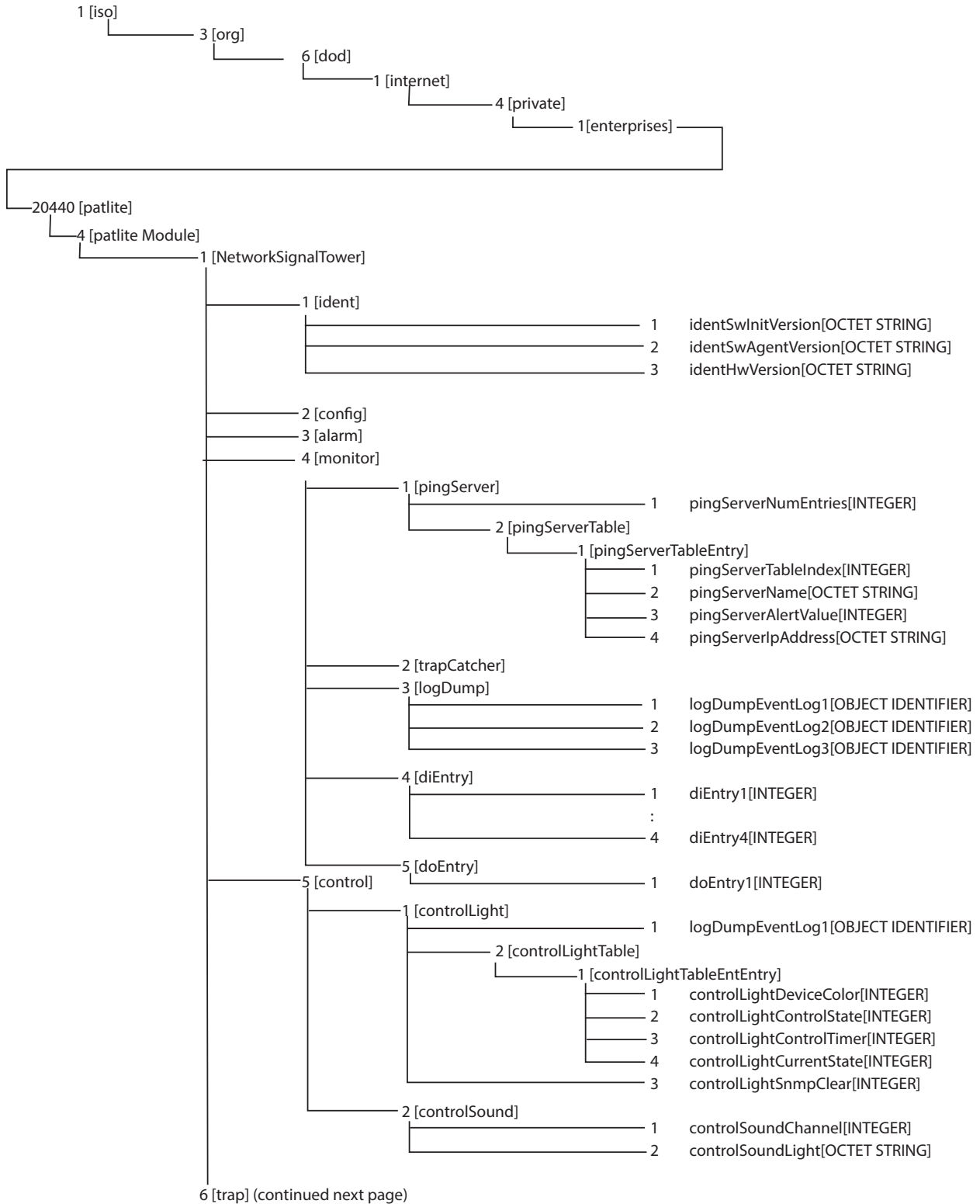

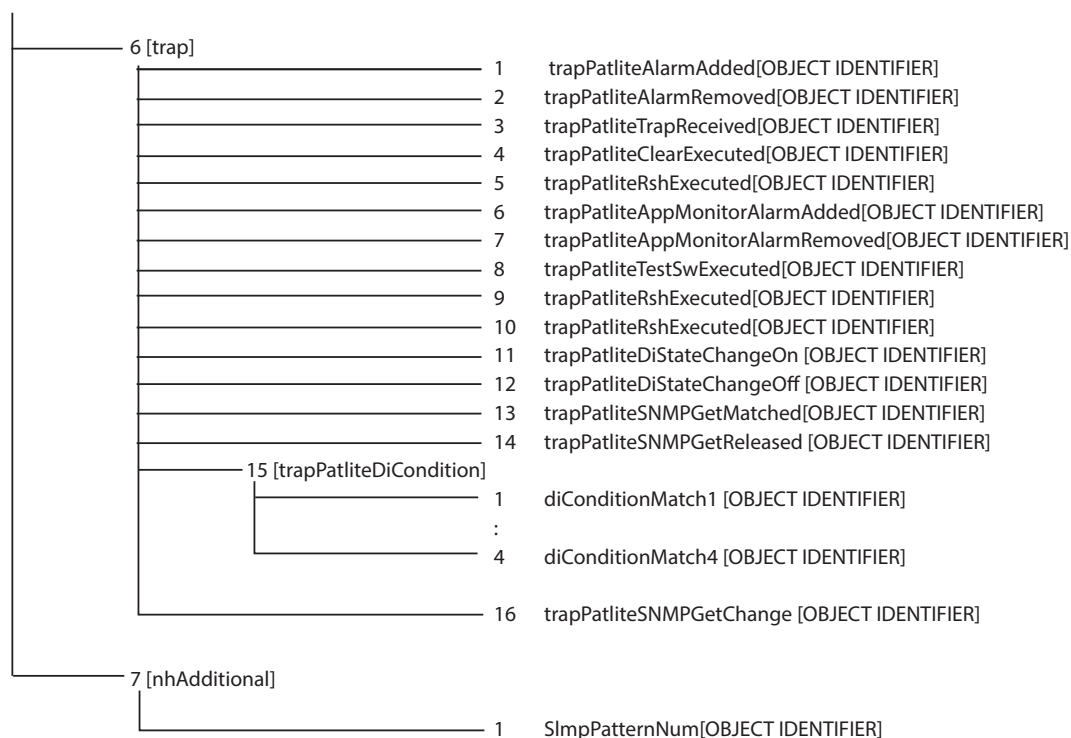

Table 5.0.0–1 Generic Trap

OID	Name	Model	MAX-ACCESS	Description
1.3.6.1.6.3.1.1.5.1	coldStart	OBJECT-IDENTIFIER	not-accessible	It will transmit when the main unit has been rebooted.

Table 5.0.0–2 net-snmp

OID	Name	Model	MAX-ACCESS	Description
1.3.6.1.2.1.1	system			
1.3.6.1.2.1.1.3	sysUpTime	TimeTick	read-only	The time elapsed after the SNMP management system has rebooted. (In 1/100 seconds)
1.3.6.1.2.1.1.4	sysContact	DisplayString (SIZE (0..255))	read-only	It is the contact for the Web setup tool System Setup.
1.3.6.1.2.1.1.5	sysName	DisplayString (SIZE (0..255))	read-only	It is the host name for the Web setup tool System Setup.
1.3.6.1.2.1.1.6	sysLocation	DisplayString (SIZE (0..255))	read-only	It is a installation location for the Web setup tool System Setup.

Table 5.0.0-3 NH\_- \_FV1 OID Characteristics

OID	Name	Model	MAX-ACCESS	Description
4	Patlite Module			
4.1	networkSignalTower			
4.1.1	ident			
4.1.1.1	identSwNitVersion	OCTET-STRING(2)	read-only	OS Version
4.1.1.2	identSwAgentVersion	OCTET-STRING(3)	read-only	Application Version
4.1.1.3	identhwVersion	OCTET-STRING(3)	read-only	Hardware Version
4.1.2	config			
4.1.3	alarm			
4.1.4	monitor			
4.1.4.1	pingServer			
4.1.4.1.1	pingServerNumEntries	INTEGER {0.. 24}	read-only	The ping monitoring number is stored.
4.1.4.1.2	pingServerTable			
4.1.4.1.2.1	pingServerTableEntry			
4.1.4.1.2.1.1	pingServerTableIndex	INTEGER {0.. 24}	read-only	The Setup number of a PING monitor is stored.
4.1.4.1.2.1.2	pingServerName	OCTET-STRING(31)	read-only	The ping monitor device name is stored.
4.1.4.1.2.1.3	pingServerAlertValue	INTEGER {normal(1), occurred(2)}	read-only	The ping monitor status is stored. Normal (1), ping monitor abnormality (2)
4.1.4.1.2.1.4	pingServerIpAddress	OCTET-STRING(63)	read-only	The ping monitor covering the IP address is stored.
4.1.4.2	trapCatcher			
4.1.4.3	logDump			
4.1.4.3.1 - 4.1.4.3.3	logDumpEventLog1-3	OBJECT-IDENTIFIER	read-only	The event log is stored. logDumpEventLog1 is stored from lines 1-85. logDumpEventLog2 is stored from lines 86-170. logDumpEventLog3 is stored from lines 171-255.
4.1.4.4	diEntry			
4.1.4.4.1 - 4.1.4.4.4	diEntry1-4	INTEGER {off(0), on(1)}	read-only	The digital inputs 1-4 status is stored. OFF(0) / ON(1)
4.1.4.5	doEntry			
4.1.4.5.1	doEntry1	INTEGER {off(0), on(1)}	read-write	The digital output 1 status is stored. The digital output can be controlled by a SNMP SET command. OFF(0) / ON(1)

Table 5.0.0-4 NH\_-\_FV1 OID Characteristics (cont.)

OID	Name	Model	MAX-ACCESS	Description
4.1.5	control			
4.1.5.1	controlLight			
4.1.5.1.1	controlLightNumEntries	INTEGER {0..5}	read-only	The number of Signal Towers to control is stored.
4.1.5.1.2	controlLightTable			
4.1.5.1.2.1	controlLightTableEntEntry			
4.1.5.1.2.1.1	controlLightDeviceColor	INTEGER { red(1), yellow(2), green(3), Blue(4), clear(5), Buzzer(6)}	read-write	The color of the Signal Tower to control is stored. The color of the Signal Tower controlled by the SNMP SET command can be specified. Red (1) / Yellow (2) / Green (3) Blue (4) / White (5) / Buzzer (6)
4.1.5.1.2.1.2.(index)*	controlLightControlState	INTEGER { turn-off(1), turn-on(2), blinking-pattern 1(3), nop(4), blinking-pattern 2(5), sound-pattern 4(6)}	read-write	The status to control the Signal Tower is stored. The status of the Signal Tower controlled by the SNMP SET command can be specified. If the value 0-99 is stored in "controlLightControlTimer", it will take effect.  Lights Out/Stop Buzzer (1) Lighting/channel 61 (buzzer pattern 1) (2) Flashing pattern 1/channel 62 (buzzer pattern 2) (3) No Change (4) Flashing pattern 2/channel 63 (buzzer pattern 3) (5) Channel 64 (buzzer pattern 4) (6)
4.1.5.1.2.1.3.(index)*	controlLightControlTimer	INTEGER {-1.. 99}	read-write	The amount of seconds the restoration timer can be set for the SNMP SET command. If the value of -1 is stored, the "controlLightControlState" will become invalid. (-1-99)
4.1.5.1.2.1.4.(index)*	controlLightCurrentState	INTEGER { turn-off(1), turn-on(2), blinking-pattern 1(3), nop(4), blinking-pattern 2(5), sound-pattern 4(6)}	read-only	The current status of the Signal Tower is stored.  Lights Out/Stop Buzzer (1) Lighting/channel 61 (buzzer pattern 1) (2) Flashing pattern 1/channel 62 (buzzer pattern 2) (3) No Change (4) Flashing pattern 2/channel 63 (buzzer pattern 3) (5) Channel 64 (buzzer pattern 4) (6)
4.1.5.1.3	controlLightSnmpClear	INTEGER { nop(0), execute(1)}	read-write	The "Clear" operation can be executed by the SNMP SET command.
4.1.5.2	controlSound			
4.1.5.2.1	controlSoundChannel	INTEGER {0.. 70}	read-write	The playback channel number is stored. The one shot playback channel number executed by the SNMP SET command can be specified. (1-70) The channel playback stop can be specified by the SNMP SET command. (0)

\* The value to operate the Signal Tower or buzzer is entered into the (index).

Red (1) / Yellow (2) / Green (3) / Blue (4) / White (5) / Buzzer (6)

Table 5.0.0-5 NH\_ \_FV1 OID Characteristics (cont.)

OID	Name	Model	MAX-ACCESS	Description
4.1.5.2.2	controlSoundLight	OCTET-STRING (SIZE(12))	read-write	The status of the SNMP SET command controlling the Signal Tower and channel playback can be specified by using 12 digits. 1-5 figures: lights off (0), lighting (1), Flashing pattern 1 (2), Flashing pattern 2 (3), No Change (9) 6 figures: Stop (0), Playback (1) 7-9 figures: Message Repeat (000-255) 10-12 figures: Channel Playback (001-070)
4.1.6	trap			
4.1.6.1	trapPatliteAlamAdded	OBJECT-IDENTIFIER	not-accessible	The monitoring object set up for the Ping monitor setups 1-24 can transmit when abnormalities occur.
4.1.6.2	trapPatliteAlamRemoved	OBJECT-IDENTIFIER	not-accessible	The monitoring object set up for the Ping monitor setups 1-24 can transmit when recovery from an abnormality occurs.
4.1.6.3	trapPatliteTrapReceived	OBJECT-IDENTIFIER	not-accessible	It will transmit when the TRAP, set up by the TRAP reception setting 1-16, is received.
4.1.6.4	trapPatliteClearExecuted	OBJECT-IDENTIFIER	not-accessible	It will transmit when the "Clear" button is pushed.
4.1.6.5	trapPatliteRshExecuted	OBJECT-IDENTIFIER	not-accessible	It will transmit when the RSH command is received.
4.1.6.6	trapPatliteAppMonitor -AlarmAdded	OBJECT-IDENTIFIER	not-accessible	It will transmit when abnormalities, set up by the application monitor Setups 1-4, occur in the monitoring object.
4.1.6.7	trapPatliteAppMonitor -AlarmRemoved	OBJECT-IDENTIFIER	not-accessible	It will transmit when abnormalities, set up by the application monitor Setups 1-4, are restored to the monitoring object.
4.1.6.8	trapPatliteTestSw -Executed	OBJECT-IDENTIFIER	not-accessible	It will transmit when the test switch is pushed.
4.1.6.9	trapPatliteSLMPAction	OBJECT-IDENTIFIER	not-accessible	It will transmit when the SLMP conditions agree.
4.1.6.10	trapPatliteSLMPError	OBJECT-IDENTIFIER	not-accessible	It will transmit when the SLMP error data is received.
4.1.6.11	trapPatliteDiState -ChangeOn	OBJECT-IDENTIFIER	not-accessible	It will transmit when the digital inputs 1-4 are turned on.
4.1.6.12	trapPatliteDiState -ChangeOff	OBJECT-IDENTIFIER	not-accessible	It will transmit when the digital inputs 1-4 are turned off.
4.1.6.13	trapPatliteSNMP -GetMatched	OBJECT-IDENTIFIER	not-accessible	It transmits when the SNMP monitor conditions agree.
4.1.6.14	trapPatliteSNMP -GetReleased	OBJECT-IDENTIFIER	not-accessible	It transmits when the SNMP monitor conditions are canceled.
4.1.6.15	trapPatliteDiCondition			
4.1.6.15.1 - 4.1.6.15.4	diConditionMatch1-4	OBJECT-IDENTIFIER	not-accessible	It transmits when the conditions set up in the digital input 1-4 condition setup agrees.
4.1.6.16	trapPatliteSNMPGetChange	OBJECT-IDENTIFIER	not-accessible	It transmits when there is a change detected in the SNMP monitor.
4.1.7	nhAdditional			
4.1.7.1	SlmpPatternNum	OBJECT-IDENTIFIER	not-accessible	The setup number corresponding to the SLMP conditions is stored.

# 6. Replacement Parts Option Parts

## 6.1. Replacement Parts

The repair parts of this product are as follows. when repair parts are needed, contact your PATLITE sales representatives.

Table 6.1 Replacement Parts of NH-FV

Parts
Head Cover, $\phi$ 40, Off-white(NHP)
Head Cover, $\phi$ 60, Off-white(NHL)
Rubber Feet
AC Adaptor(1 plug) *

\* Replacement plug is not included in the AC adapter (1 plug) of repair parts.

Please purchase our AC adapter (ADP-001) when you need AC adapter with replacement plug included.

## 6.2. Option Parts

This product has the following optional items

Table 6.2 Option Parts

Parts	Model
Wall Bracket	NH-WST2
Tint Film	NHL-TF、NHP-TF

### 6.2.1. Tint Film

Tint Film is a film that suppresses brightness when the LED unit is dazzling.

<b>⚠ CAUTION</b>	
⊘	<ul style="list-style-type: none"> <li>When removing dirt, oil and moisture, please do not wipe it up by volatile medicine and a chemical dustcloth of a benzene and a paint thinner. It may cause deformation or product failure.</li> <li>Be careful as the LED unit can not be removed if Tint Film is pasted across a plurality of LED units.</li> <li>Do not reuse the pasted Tint Film. The adhesive force of the double-sided tape decrease.</li> </ul>
!	<ul style="list-style-type: none"> <li>When sticking a Tint film, please remove dirt, oil and moisture.</li> <li>Please use it as described in the instruction manual.</li> </ul>

Please paste Tint Film by the following procedure.

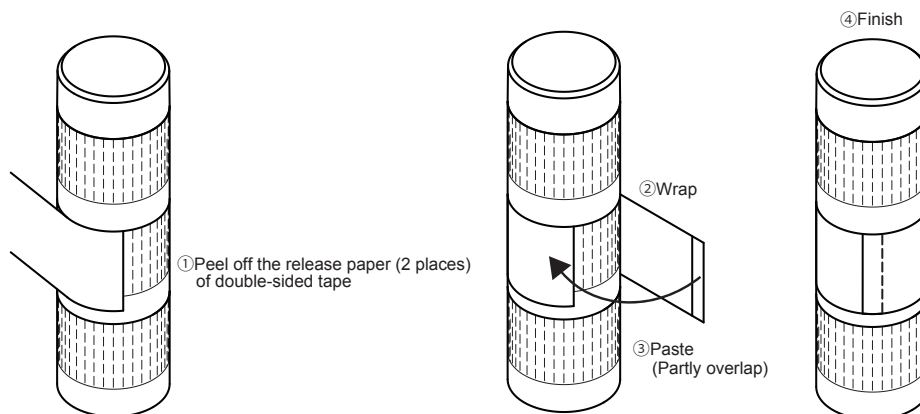



## 6.2.2. Cooperation services

### PATLITE Playlist Editor 2 (Free)

It is a free voice rewriting tool. PATLITE Playlist Editor 2 is downloadable from the following website.  
<https://www.patlite.com/oto/index0910.html>

- Please refer to the above-mentioned website for the details of PATLITE Playlist Editor 2

## 6.3. About LED Unit

To purchase the LED unit , please purchase the LR type LED unit shown in the table below.

Table 6.3 LED Unit

Parts	型式
LED Unit Red (NHP $\phi$ 40)	LR4-E-RZ
LED Unit Amber (NHP $\phi$ 40)	LR4-E-YZ
LED Unit Green (NHP $\phi$ 40)	LR4-E-GZ
LED Unit Blue (NHP $\phi$ 40)	LR4-E-BZ
LED Unit White (NHP $\phi$ 40)	LR4-E-C
LED Unit Red (NHL $\phi$ 60)	LR6-E-RZ
LED Unit Amber (NHL $\phi$ 60)	LR6-E-YZ
LED Unit Green (NHL $\phi$ 60)	LR6-E-GZ
LED Unit Blue (NHL $\phi$ 60)	LR6-E-BZ
LED Unit White (NHL $\phi$ 60)	LR6-E-C

### 6.3.1. How to attach and detach LED Unit

To rearrange the arrangement of the LED units, etc., perform the following procedure.

<b>⚠ WARNING</b>	
⊘	<ul style="list-style-type: none"> <li>The maximum number of attachment units per product are five LED units and one Head Cover. Do not attach more units.</li> <li>Do not remove the body from the main body. Failure to comply may result in failure to this product.</li> <li>Do not attach same color LED units to one product at the same time.</li> </ul>
!	<ul style="list-style-type: none"> <li>Be sure the power is disconnected before working on this product.</li> </ul>

<b>⚠ CAUTION</b>	
⊘	<ul style="list-style-type: none"> <li>Do not apply excessive strength with each unit or body. Failure to comply may damage the unit.</li> <li>Do not touch the connector area or the inside of the body and LED unit. Failure to comply may damage the unit.</li> <li>Do not attach units not used in this product, such as WDT-6LR-Z2 or LR Buzzer unit, to this product.</li> </ul>
!	<ul style="list-style-type: none"> <li>Be sure to lock each unit securely when attaching. Failure to comply may damage the unit.</li> <li>Detach the unit in the following manner. Any other method may result in damaging the product.</li> </ul>

#### ■ Removal method

Remove adjacent units one by one in order from the top in order.

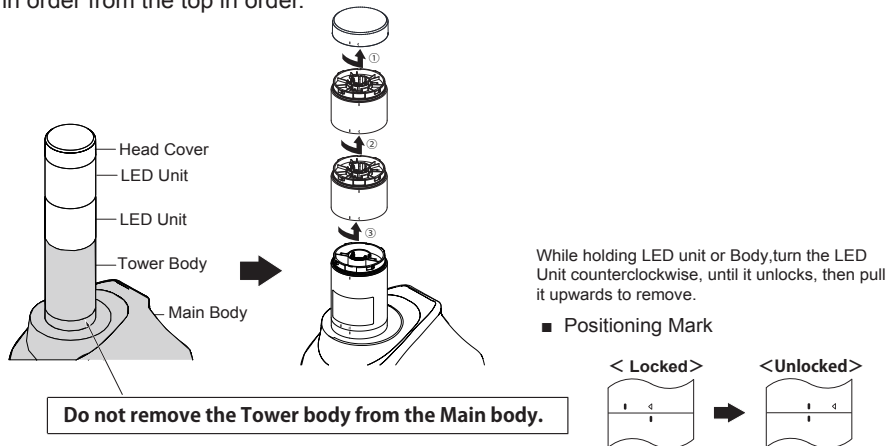

#### ■ Attachment method

Attach adjacent units one by one in order from the bottom in order.

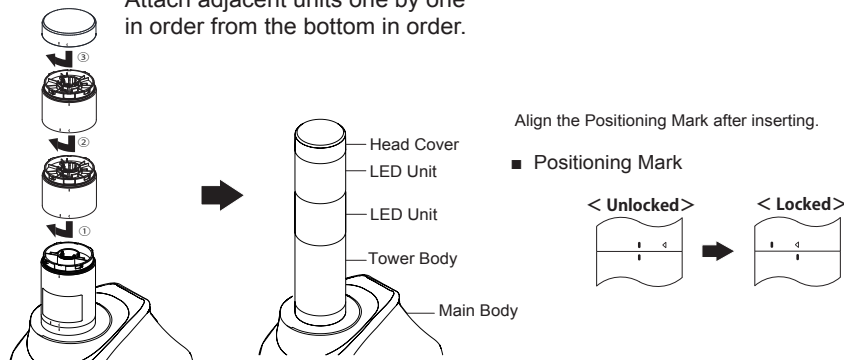

If the LED Unit can't be attached, try the procedure below.

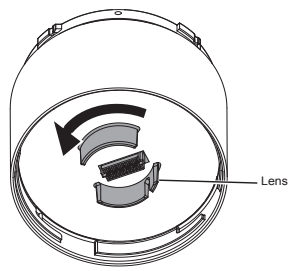

LED Unit Underside View

Turn the internal lens of the LED Unit counterlockwise until the tab fits in the groove.  
Attach the LED Unit to the product.

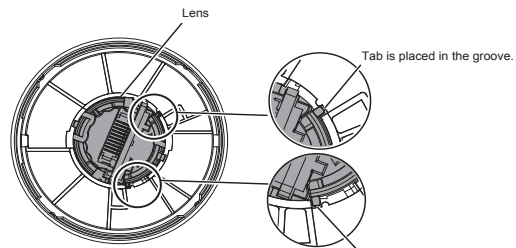

LED Unit Topside View (Attachable)

**MEMO**

Regarding how to attach and detach the LED unit, it is also listed in the product manual of the signal tower (LR series).

# 7. Inspection and Maintenance

### [Cleaning]

- When cleaning, be sure to disconnect the power first.
- The cleaning of this product should be with a soft cloth and a neutral detergent (such as dish soap), diluted with water and should be wiped lightly.
- Do not wipe This product with volatile chemicals, or chemically treated dustcloth containing benzene, thinner etc.
- Do not wipe with a cloth containing too much moisture. If moisture gets inside the product, it can cause short circuiting, electric shock, or fire.
- Periodically remove dust from the electric socket to prevent a fire hazard. By allowing dust to adhere to the power supply terminal, it can be the result of fire or failure from short-circuiting.

### [Inspection]

- Check the following contents when inspecting this product.

Inspection Checklist		Inspection Contents
Supplied Power Source	Power Supply Voltage Tolerance	Tolerable Voltage Range should be from AC 100V to 240V.
Surrounding Environment	Ambient Temperature	Operating Temperature Range should be between 0°C and +40°C.
	Ambient Humidity	Operating Humidity Range should be between 20 and 80%RH.
	Presence of Dust	No dust should be accumulated.
Is the wiring or cord loose or have too much slack?		Be sure no excessive slack or looseness is present.

# 8. Troubleshooting

Problem	Possible Cause
The power source does not turned on.	Check whether the AC Adaptor is properly connected.
The signal tower is bright (or dazzling)	Please use "Tint Film (NHP-TF)" (optional parts)
The Status LED started blinking when the Main Unit was turned on.	Is the schedule function active? If the schedule function is blinking but not flashing, contact your nearest PATLITE Sales Representative for technical consultation.
It does not operate in DHCP mode.	Check that the environment is connectable with a DHCP server.
The Web setup tool is not displayed.	Check that the LAN cable is connected (LINK display LED lights up). Check whether the Main Unit mode switch is set as "NORMAL."
When logging into the Web setup tool, a browser error occurs.	Check whether the IP address etc. which is displayed on the address bar of the browser is correct.
	Check if the network Setup of the PC using the browser is connected with this product.
	Check whether the security Setup and page JavaScript automatic reading for the browser is activated.
The relay contact controlled by the digital output function does not operate.	Check whether the digital output is set. [Confirmation Location] "Web Setup Tool"-"Setup Menu"- "Relay Contact Output Settings"
	Check whether the digital output status is changing for a short time. An output terminal reflects the digital output status in a 100 ms cycle. The digital output status is updated as required in the order of received control content. (Priority is given to the last) For this reason, when the digital output status changes within 100 ms, only that portion of the status occurs in the output terminal. * Various transmission commands and E-mail Sending reflects the order of control content.
	When a lot of management happens in other functions or when management takes time, an output terminal operation may be delayed.
	Check whether the "Automatic OFF" is set.
	Contact parts may be damaged. Refer to the information at the end of this book, or ask the store where the product was purchased. Check whether the rated current of the equipment linked to the Terminal Buss and the inrush current were over the output terminal ratings.
	Is the schedule function active? If the schedule function is active, relay contacts will not operate.
A digital input does not turn on (The status change is not detected).	The digital input does not turn off. [Confirmation place] Web Setup Tool"- "Operation Setup Index"- "Digital Input Set up."
	Check whether there are no open circuits, unconnected wires, short circuit, etc. in the input terminal wiring.
	Check whether the input signal is correctly transmitting to the input terminal. The input signal requires a delay of 110 ms or more.
The event log is not recording.	It is saved and erased when there is a "power shut down", or a "reboot" or pressing the "reset" button is executed.
The application monitor is not operating.	Check whether the Socket Communication is disconnected from the monitoring object application. (If it is disconnected, the monitoring function will stop.)
No operation occurs when there are abnormalities during the application monitor. No operation occurs when there are abnormalities during a Ping monitor.	If a "Clear" switch function is executed during an abnormal condition run time of the operation, because this product is continuing a monitor abnormality status, it will not operate on a monitor abnormality again. A status "Clear" function, or monitoring object acknowledgement has to be performed for this product to return to a monitoring condition.
	Is the schedule function active? When the schedule function is active, the notification operation is no longer active.
	When set to a BUSY output by the "relay output contact setup", the relay contact output stays ON during channel playback. When the channel playback stops, the relay-contact output is turned off. It cannot be turned OFF by various commands.
Even when the "Clear" switch is pushed, the relay-contact output does not turn off.	

Problem	Possible Cause
The Signal Tower will not switch off, even if the "Clear" switch is pressed.	Check whether it is set up for "Lighting", using the normal operation Setup. The Signal Tower color is set up for "Lighting" when the "Clear" switch is pressed.
	Check whether the "Clear" Control Setup parameter for "Clear Signal Tower" is set to "Inactive." To switch off the Signal Tower when pressing the clear switch, set it to "Active."
The RSH command cannot be controlled.	The "Designated Sender Address" should be checked as to whether the "designated sender IP address" and "account" are set up correctly, if it is activated.
	If the "Designated Sender Address" is invalid, the "common account" should be checked if it is set up correctly.
	When the command to omit an account is transmitted, check whether the correct account was registered. [Confirmation Location] "Web Setup Tool"-"Setup Menu"-"Relay Contact Output Settings"
	Check that the equipment setup for the designated sender, and the transmission route to the communication facility for the RSH command is not intercepted (whether the RSH command is transmitted to this product, or is going through a firewall, being filtered, or by a port block function, etc.). The following is the structure of the communication ports during an RSH command reception. Client: NH-FV ANY ----- FW -----> 514 ANY <----- FW ----- ANY ANY is automatically set up between 512-1023.
	Is the schedule function active? When the schedule function is active, the notification operation is no longer active.
The digital output and various transmission do not work with the digital input conditions set up.	Check whether the set-up conditions are conflicting. Priority is given to the Setup number operation in which the "Digital Input Condition Settings" was processed in an order from Setup 1, and was processed after.
	Without pressing the "Clear" switch, check the operating condition in the "Clear" Condition status to make sure it is set as "Active", and that the conditions will clear when the "Clear" switch is pressed. [Confirmation Location]
	Check the authentication method and setup for "Web Setup Tool"-"Operation Setup Parameters"-"Digital Input Condition Settings" and mail server.
	Is the schedule function active? When the schedule function is active, the notification operation is no longer active.
The e-mail transmission does not work.	Check the authentication method and setup for the mail server.
	When the set up is by the host name, check whether the DNS server address is correctly set up. [Confirmation Location] "Web Setup Tool"-"Setup Items"-"Network Setup"
The HTTP Command cannot be controlled.	Check the HTTP command control function is set to the "Active". Refer to "4.1 System Configuration Screen"
	Is the schedule function active? When the schedule function is active, the notification operation is no longer active.
Cannot get the SNMP SET/GET to work.	Check whether each community name is set up correctly.
	Is the schedule function active? When the schedule function is activated, it cannot be controlled through the SET.
A channel does not play back. There is no sound coming out from the speaker.	Check the volume on the side of the body, and increase the volume if it is small. Also check the master volume in the Web setup tool "System Configuration."
	When the sound does not come out of channels 1-30 during playback, check the sound-volume Setup in the Playlist Package.
	Check whether the MP3 file is registered into the channel.
	Is the schedule function active? If the schedule function is activated, the channel playback is no longer active.

Problem	Possible Cause
The channel lineout does not work.	Check whether the MP3 file is a monophonic recording. For stereo, the lineout output data of the Right channel of the MP3 file is registered into a mini jack output.
	Check whether the lineout function of the channel is set as "Active." The Setup parameters for every lineout channel is displayed as a BUSY output mode by setting a relay-contact output. [Confirmation Location] "Web Setup Tool"- "Setup Menu"- "Sound Channel Setup" "Web Setup Tool"- "Setup Menu"- "Relay Contact Output Settings"
Sound comes out only on one side of the lineout.	The lineout is a monophonic channel. When a stereo mini plug cable is connected, it plays back from the lineout Left channel.
A channel does not stop by a specified number of times.	The Setup frame in the Playlist Package may have the Repeat Playback set up for indefinitely, even if it indicates a playback pattern, all becomes an endless playback.
Even if an event occurs, channel playback does not change. (Memory Playback Mode)	The Setup frame in the Playlist Package may have the Repeat Playback set up for indefinite, even if it indicates a playback pattern, all becomes an endless playback. To play back the memory channel which was in memory playback mode: - Transmit the RSH "Stop" command. - With the "Clear" operation setup, set the clear switch for "Sending Music" and press the clear switch.
The channel is not registered into a channel memory.	A channel memory is erased when channels 61-64 (buzzer pattern 1-4) is played back. Refer to "3.1.7 Playback mode" for details.
Even when performing an event, channels 61-64 (Buzzer Patterns 1-4) do not change. (Memory Playback Mode)	The playback mode for channels 61-64 (Buzzer Patterns 1-4) is fixed as a repeat playback (endless) channel. In order to change to other channels, use a command or switch operation to direct a channel to play back or send music after the buzzer has stopped.
Uploading an MP3 file causes an error.	It is most likely an MP3 file which was not created in a compatible format. The formats compatible with this product are as follows: MPEG1AudioLayer3 CBR; 32, 64 or 128k bps
The SNMP Supported Equipment Monitor Function does not work.	Register the community name for the monitoring object equipment GET command reception community name.
	Check whether the monitor cycle is 0.
	When the registered OID is deleted, but the monitoring function operates, the registration OID will have an error. Re-enter the correct OID.
All Signal Tower tiers are flashing pattern 2, and an announcement plays; "A writing error occurred when storing."	Check whether there is a connection problem, the files are corrupted, or the USB memory is damaged.
All Signal Tower tiers are flashing pattern 2, and an announcement plays; "Setup information is incorrect."	The configuration data has an error, or the USB memory has been damaged. Generate the correct configuration data, and try again.
All Signal Tower tiers are flashing pattern 2, and an announcement plays; "The USB memory does not contain data."	Be sure to set the folder structure in the USB memory according to hierarchy, and that the required data is stored in the correct folder with the correct file name. Refer to "3.21 USB Memory Function" for details.
All Signal Tower tiers are flashing pattern 2, and an announcement plays; "The USB memory file system cannot be recognized."	Be sure to format the USB memory into FAT or FAT32.
The status LED is flashing pattern 2, and an announcement plays; "The USB memory file system cannot be recognized."	Be sure to format the USB memory into FAT or FAT32.
The status LED is flashing pattern 2, and an announcement plays; "A writing error occurred when storing."	Check whether the USB memory connection is bad, and whether available memory is sufficient or not.

# 9. Freeware Terms of Agreement

The following chapters clearly outlines the copyrights for the freeware software used with this product.

## 9.1. GNU GENERAL PUBLIC LICENCE

GNU GENERAL PUBLIC LICENSE

Version 2, June 1991

Copyright (C) 1989, 1991 Free Software Foundation, Inc.  
675 Mass Ave, Cambridge, MA 02139, USA

Everyone is permitted to copy and distribute verbatim copies of this license document, but changing it is not allowed.

### Preamble

The licenses for most software are designed to take away your freedom to share and change it. By contrast, the GNU General Public License is intended to guarantee your freedom to share and change free software--to make sure the software is free for all its users. This General Public License applies to most of the Free Software Foundation's software and to any other program whose authors commit to using it. (Some other Free Software Foundation software is covered by the GNU Library General Public License instead.) You can apply it to your programs, too.

When we speak of free software, we are referring to freedom, not price. Our General Public Licenses are designed to make sure that you have the freedom to distribute copies of free software (and charge for this service if you wish), that you receive source code or can get it if you want it, that you can change the software or use pieces of it in new free programs; and that you know you can do these things.

To protect your rights, we need to make restrictions that forbid anyone to deny you these rights or to ask you to surrender the rights. These restrictions translate to certain responsibilities for you if you distribute copies of the software, or if you modify it.

For example, if you distribute copies of such a program, whether gratis or for a fee, you must give the recipients all the rights that you have. You must make sure that they, too, receive or can get the source code. And you must show them these terms so they know their rights.

We protect your rights with two steps: (1) copyright the software, and (2) offer you this license which gives you legal permission to copy, distribute and/or modify the software.

Also, for each author's protection and ours, we want to make certain that everyone understands that there is no warranty for this free software. If the software is modified by someone else and passed on, we want its recipients to know that what they have is not the original, so that any problems introduced by others will not reflect on the original authors' reputations.

Finally, any free program is threatened constantly by software patents. We wish to avoid the danger that redistributors of a free program will individually obtain patent licenses, in effect making the program proprietary. To prevent this, we have made it clear that any patent must be licensed for everyone's free use or not licensed at all.

The precise terms and conditions for copying, distribution and modification follow.

GNU GENERAL PUBLIC LICENSE

TERMS AND CONDITIONS FOR COPYING, DISTRIBUTION AND MODIFICATION

0. This License applies to any program or other work which contains a notice placed by the copyright holder saying it may be distributed under the terms of this General Public License. The "Program", below, refers to any such program or work, and a "work based on the Program" means either the Program or any derivative work under copyright law: that is to say, a work containing the Program or a portion of it, either verbatim or with modifications and/or translated into another language. (Hereinafter, translation is included without



limitation in the term “modification”.) Each licensee is addressed as “you”.

Activities other than copying, distribution and modification are not covered by this License; they are outside its scope. The act of running the Program is not restricted, and the output from the Program is covered only if its contents constitute a work based on the Program (independent of having been made by running the Program). Whether that is true depends on what the Program does.

1. You may copy and distribute verbatim copies of the Program’s source code as you receive it, in any medium, provided that you conspicuously and appropriately publish on each copy an appropriate copyright notice and disclaimer of warranty; keep intact all the notices that refer to this License and to the absence of any warranty; and give any other recipients of the Program a copy of this License along with the Program.

You may charge a fee for the physical act of transferring a copy, and you may at your option offer warranty protection in exchange for a fee.

2. You may modify your copy or copies of the Program or any portion of it, thus forming a work based on the Program, and copy and distribute such modifications or work under the terms of Section 1 above, provided that you also meet all of these conditions:
  - a) You must cause the modified files to carry prominent notices stating that you changed the files and the date of any change.
  - b) You must cause any work that you distribute or publish, that in whole or in part contains or is derived from the Program or any part thereof, to be licensed as a whole at no charge to all third parties under the terms of this License.
  - c) If the modified program normally reads commands interactively when run, you must cause it, when started running for such interactive use in the most ordinary way, to print or display an announcement including an appropriate copyright notice and a notice that there is no warranty (or else, saying that you provide a warranty) and that users may redistribute the program under these conditions, and telling the user how to view a copy of this License. (Exception: if the Program itself is interactive but does not normally print such an announcement, your work based on the Program is not required to print an announcement.)

These requirements apply to the modified work as a whole. If identifiable sections of that work are not derived from the Program, and can be reasonably considered independent and separate works in themselves, then this License, and its terms, do not apply to those sections when you distribute them as separate works. But when you distribute the same sections as part of a whole which is a work based on the Program, the distribution of the whole must be on the terms of this License, whose permissions for other licensees extend to the entire whole, and thus to each and every part regardless of who wrote it.

Thus, it is not the intent of this section to claim rights or contest your rights to work written entirely by you; rather, the intent is to exercise the right to control the distribution of derivative or collective works based on the Program.

In addition, mere aggregation of another work not based on the Program with the Program (or with a work based on the Program) on a volume of a storage or distribution medium does not bring the other work under the scope of this License.

3. You may copy and distribute the Program (or a work based on it, under Section 2) in object code or executable form under the terms of Sections 1 and 2 above provided that you also do one of the following:
  - a) Accompany it with the complete corresponding machine-readable source code, which must be distributed under the terms of Sections 1 and 2 above on a medium customarily used for software interchange; or,
  - b) Accompany it with a written offer, valid for at least three years, to give any third party, for a charge no more than your cost of physically performing source distribution, a complete machine-readable copy of the corresponding source code, to be distributed under the terms of Sections 1 and 2 above on a medium customarily used for software interchange; or,
  - c) Accompany it with the information you received as to the offer to distribute corresponding source

code. (This alternative is allowed only for noncommercial distribution and only if you received the program in object code or executable form with such an offer, in accord with Subsection b above.)

The source code for a work means the preferred form of the work for making modifications to it. For an executable work, complete source code means all the source code for all modules it contains, plus any associated interface definition files, plus the scripts used to control compilation and installation of the executable. However, as a special exception, the source code distributed need not include anything that is normally distributed (in either source or binary form) with the major components (compiler, kernel, and so on) of the operating system on which the executable runs, unless that component itself accompanies the executable.

If distribution of executable or object code is made by offering access to copy from a designated place, then offering equivalent access to copy the source code from the same place counts as distribution of the source code, even though third parties are not compelled to copy the source along with the object code.

4. You may not copy, modify, sublicense, or distribute the Program except as expressly provided under this License. Any attempt otherwise to copy, modify, sublicense or distribute the Program is void, and will automatically terminate your rights under this License. However, parties who have received copies, or rights, from you under this License will not have their licenses terminated so long as such parties remain in full compliance.
5. You are not required to accept this License, since you have not signed it. However, nothing else grants you permission to modify or distribute the Program or its derivative works. These actions are prohibited by law if you do not accept this License. Therefore, by modifying or distributing the Program (or any work based on the Program), you indicate your acceptance of this License to do so, and all its terms and conditions for copying, distributing or modifying the Program or works based on it.
6. Each time you redistribute the Program (or any work based on the Program), the recipient automatically receives a license from the original licensor to copy, distribute or modify the Program subject to these terms and conditions. You may not impose any further restrictions on the recipients' exercise of the rights granted herein. You are not responsible for enforcing compliance by third parties to this License.
7. If, as a consequence of a court judgment or allegation of patent infringement or for any other reason (not limited to patent issues), conditions are imposed on you (whether by court order, agreement or otherwise) that contradict the conditions of this License, they do not excuse you from the conditions of this License. If you cannot distribute so as to satisfy simultaneously your obligations under this License and any other pertinent obligations, then as a consequence you may not distribute the Program at all. For example, if a patent license would not permit royalty-free redistribution of the Program by all those who receive copies directly or indirectly through you, then the only way you could satisfy both it and this License would be to refrain entirely from distribution of the Program.

If any portion of this section is held invalid or unenforceable under any particular circumstance, the balance of the section is intended to apply and the section as a whole is intended to apply in other circumstances.

It is not the purpose of this section to induce you to infringe any patents or other property right claims or to contest validity of any such claims; this section has the sole purpose of protecting the integrity of the free software distribution system, which is implemented by public license practices. Many people have made generous contributions to the wide range of software distributed through that system in reliance on consistent application of that system; it is up to the author/donor to decide if he or she is willing to distribute software through any other system and a licensee cannot impose that choice.

This section is intended to make thoroughly clear what is believed to be a consequence of the rest of this License.

8. If the distribution and/or use of the Program is restricted in certain countries either by patents or by copyrighted interfaces, the original copyright holder who places the Program under this License may add an explicit geographical distribution limitation excluding those countries, so that distribution is permitted only in or among countries not thus excluded. In such case, this License incorporates the limitation as if written in the body of this License.
9. The Free Software Foundation may publish revised and/or new versions of the General Public License from time to time. Such new versions will be similar in spirit to the present version, but may differ in detail to address new problems or concerns.

Each version is given a distinguishing version number. If the Program specifies a version number of this License which applies to it and "any later version", you have the option of following the terms and conditions

either of that version or of any later version published by the Free Software Foundation. If the Program does not specify a version number of this License, you may choose any version ever published by the Free Software Foundation.

10. If you wish to incorporate parts of the Program into other free programs whose distribution conditions are different, write to the author to ask for permission. For software which is copyrighted by the Free Software Foundation, write to the Free Software Foundation; we sometimes make exceptions for this. Our decision will be guided by the two goals of preserving the free status of all derivatives of our free software and of promoting the sharing and reuse of software generally.

## NO WARRANTY

11. BECAUSE THE PROGRAM IS LICENSED FREE OF CHARGE, THERE IS NO WARRANTY FOR THE PROGRAM, TO THE EXTENT PERMITTED BY APPLICABLE LAW. EXCEPT WHEN OTHERWISE STATED IN WRITING THE COPYRIGHT HOLDERS AND/OR OTHER PARTIES PROVIDE THE PROGRAM "AS IS" WITHOUT WARRANTY OF ANY KIND, EITHER EXPRESSED OR IMPLIED, INCLUDING, BUT NOT LIMITED TO, THE IMPLIED WARRANTIES OF MERCHANTABILITY AND FITNESS FOR A PARTICULAR PURPOSE. THE ENTIRE RISK AS TO THE QUALITY AND PERFORMANCE OF THE PROGRAM IS WITH YOU. SHOULD THE PROGRAM PROVE DEFECTIVE, YOU ASSUME THE COST OF ALL NECESSARY SERVICING, REPAIR OR CORRECTION.
12. IN NO EVENT UNLESS REQUIRED BY APPLICABLE LAW OR AGREED TO IN WRITING WILL ANY COPYRIGHT HOLDER, OR ANY OTHER PARTY WHO MAY MODIFY AND/OR REDISTRIBUTE THE PROGRAM AS PERMITTED ABOVE, BE LIABLE TO YOU FOR DAMAGES, INCLUDING ANY GENERAL, SPECIAL, INCIDENTAL OR CONSEQUENTIAL DAMAGES ARISING OUT OF THE USE OR INABILITY TO USE THE PROGRAM (INCLUDING BUT NOT LIMITED TO LOSS OF DATA OR DATA BEING RENDERED INACCURATE OR LOSSES SUSTAINED BY YOU OR THIRD PARTIES OR A FAILURE OF THE PROGRAM TO OPERATE WITH ANY OTHER PROGRAMS), EVEN IF SUCH HOLDER OR OTHER PARTY HAS BEEN ADVISED OF THE POSSIBILITY OF SUCH DAMAGES.

## END OF TERMS AND CONDITIONS

### Appendix: How to Apply These Terms to Your New Programs

If you develop a new program, and you want it to be of the greatest possible use to the public, the best way to achieve this is to make it free software which everyone can redistribute and change under these terms.

To do so, attach the following notices to the program. It is safest to attach them to the start of each source file to most effectively convey the exclusion of warranty; and each file should have at least the "copyright" line and a pointer to where the full notice is found.

```
<one line to give the program's name and a brief idea of what it does.>  
Copyright (C) 19yy <name of author>
```

This program is free software; you can redistribute it and/or modify it under the terms of the GNU General Public License as published by the Free Software Foundation; either version 2 of the License, or (at your option) any later version.

This program is distributed in the hope that it will be useful, but WITHOUT ANY WARRANTY; without even the implied warranty of MERCHANTABILITY or FITNESS FOR A PARTICULAR PURPOSE. See the GNU General Public License for more details.

You should have received a copy of the GNU General Public License along with this program; if not, write to the Free Software Foundation, Inc., 675 Mass Ave, Cambridge, MA 02139, USA.

Also add information on how to contact you by electronic and paper mail.

If the program is interactive, make it output a short notice like this when it starts in an interactive mode:

```
Gnomovision version 69, Copyright (C) 19yy name of author
```

Gnomovision comes with ABSOLUTELY NO WARRANTY; for details type `show w'. This is free software, and you are welcome to redistribute it under certain conditions; type `show c' for details.

The hypothetical commands `show w' and `show c' should show the appropriate parts of the General Public License. Of course, the commands you use may be called something other than `show w' and `show c'; they could even be mouse-clicks or menu items--whatever suits your program.

You should also get your employer (if you work as a programmer) or your school, if any, to sign a "copyright disclaimer" for the program, if necessary. Here is a sample; alter the names:

Yoyodyne, Inc., hereby disclaims all copyright interest in the program `Gnomovision' (which makes passes at compilers) written by James Hacker.

<signature of Ty Coon>, 1 April 1989  
Ty Coon, President of Vice

This General Public License does not permit incorporating your program into proprietary programs. If your program is a subroutine library, you may consider it more useful to permit linking proprietary applications with the library. If this is what you want to do, use the GNU Library General Public License instead of this License.

## 9.2. GNU LESSER GENERAL PUBLIC LICENSE

GNU LESSER GENERAL PUBLIC LICENSE  
Version 3, 29 June 2007

Copyright (C) 2007 Free Software Foundation, Inc. <<http://fsf.org/>>

Everyone is permitted to copy and distribute verbatim copies of this license document, but changing it is not allowed.

This version of the GNU Lesser General Public License incorporates the terms and conditions of version 3 of the GNU General Public License, supplemented by the additional permissions listed below.

0. Additional Definitions.

As used herein, "this License" refers to version 3 of the GNU Lesser General Public License, and the "GNU GPL" refers to version 3 of the GNU General Public License.

"The Library" refers to a covered work governed by this License, other than an Application or a Combined Work as defined below.

An "Application" is any work that makes use of an interface provided by the Library, but which is not otherwise based on the Library. Defining a subclass of a class defined by the Library is deemed a mode of using an interface provided by the Library.

A "Combined Work" is a work produced by combining or linking an Application with the Library. The particular version of the Library with which the Combined Work was made is also called the "Linked Version".

The "Minimal Corresponding Source" for a Combined Work means the Corresponding Source for the Combined Work, excluding any source code for portions of the Combined Work that, considered in isolation, are based on the Application, and not on the Linked Version.

The "Corresponding Application Code" for a Combined Work means the object code and/or source code for the Application, including any data and utility programs needed for reproducing the Combined Work from the Application, but excluding the System Libraries of the Combined Work.

1. Exception to Section 3 of the GNU GPL.

You may convey a covered work under sections 3 and 4 of this License without being bound by section 3 of the GNU GPL.

## 2. Conveying Modified Versions.

If you modify a copy of the Library, and, in your modifications, a facility refers to a function or data to be supplied by an Application that uses the facility (other than as an argument passed when the facility is invoked), then you may convey a copy of the modified version:

- a) under this License, provided that you make a good faith effort to ensure that, in the event an Application does not supply the function or data, the facility still operates, and performs whatever part of its purpose remains meaningful, or
- b) under the GNU GPL, with none of the additional permissions of this License applicable to that copy.

## 3. Object Code Incorporating Material from Library Header Files.

The object code form of an Application may incorporate material from a header file that is part of the Library. You may convey such object code under terms of your choice, provided that, if the incorporated material is not limited to numerical parameters, data structure layouts and accessors, or small macros, inline functions and templates (ten or fewer lines in length), you do both of the following:

- a) Give prominent notice with each copy of the object code that the Library is used in it and that the Library and its use are covered by this License.
- b) Accompany the object code with a copy of the GNU GPL and this license document.

## 4. Combined Works.

You may convey a Combined Work under terms of your choice that, taken together, effectively do not restrict modification of the portions of the Library contained in the Combined Work and reverse engineering for debugging such modifications, if you also do each of the following:

- a) Give prominent notice with each copy of the Combined Work that the Library is used in it and that the Library and its use are covered by this License.
- b) Accompany the Combined Work with a copy of the GNU GPL and this license document.
- c) For a Combined Work that displays copyright notices during execution, include the copyright notice for the Library among these notices, as well as a reference directing the user to the copies of the GNU GPL and this license document.
- d) Do one of the following:
  - 0) Convey the Minimal Corresponding Source under the terms of this License, and the Corresponding Application Code in a form suitable for, and under terms that permit, the user to recombine or relink the Application with a modified version of the Linked Version to produce a modified Combined Work, in the manner specified by section 6 of the GNU GPL for conveying Corresponding Source.
  1. Use a suitable shared library mechanism for linking with the Library. A suitable mechanism is one that (a) uses at run time a copy of the Library already present on the user's computer system, and (b) will operate properly with a modified version of the Library that is interface-compatible with the Linked Version.
- e) Provide Installation Information, but only if you would otherwise be required to provide such information under section 6 of the GNU GPL, and only to the extent that such information is necessary to install and execute a modified version of the Combined Work produced by recombining or relinking the Application with a modified version of the Linked Version. (If you use option 4d0, the Installation Information must accompany the Minimal Corresponding Source and Corresponding Application Code. If you use option 4d1, you must provide the Installation Information in the manner specified by section 6 of the GNU GPL for conveying Corresponding Source.)

## 5. Combined Libraries.

You may place library facilities that are a work based on the Library side by side in a single library together with other library facilities that are not Applications and are not covered by this License, and convey such a combined library under terms of your choice, if you do both of the following:

- a) Accompany the combined library with a copy of the same work based on the Library, uncombined with any other library facilities, conveyed under the terms of this License.
- b) Give prominent notice with the combined library that part of it is a work based on the Library, and explaining where to find the accompanying uncombined form of the same work.

## 6. Revised Versions of the GNU Lesser General Public License.

The Free Software Foundation may publish revised and/or new versions of the GNU Lesser General Public License from time to time. Such new versions will be similar in spirit to the present version, but may differ in detail to address new problems or concerns.

Each version is given a distinguishing version number. If the Library as you received it specifies that a certain numbered version of the GNU Lesser General Public License “or any later version” applies to it, you have the option of following the terms and conditions either of that published version or of any later version published by the Free Software Foundation. If the Library as you received it does not specify a version number of



the GNU Lesser General Public License, you may choose any version of the GNU Lesser General Public License ever published by the Free Software Foundation.

If the Library as you received it specifies that a proxy can decide whether future versions of the GNU Lesser General Public License shall apply, that proxy's public statement of acceptance of any version is permanent authorization for you to choose that version for the Library.

## 9.3. NET-SNMP

Various copyrights apply to this package, listed in various separate parts below. Please make sure that you read all the parts.

---- Part 1: CMU/UCD copyright notice: (BSD like) ----

Copyright 1989, 1991, 1992 by Carnegie Mellon University

Derivative Work - 1996, 1998-2000

Copyright 1996, 1998-2000 The Regents of the University of California

All Rights Reserved

Permission to use, copy, modify and distribute this software and its documentation for any purpose and without fee is hereby granted, provided that the above copyright notice appears in all copies and that both that copyright notice and this permission notice appear in supporting documentation, and that the name of CMU and The Regents of the University of California not be used in advertising or publicity pertaining to distribution of the software without specific written permission.

CMU AND THE REGENTS OF THE UNIVERSITY OF CALIFORNIA DISCLAIM ALL WARRANTIES WITH REGARD TO THIS SOFTWARE, INCLUDING ALL IMPLIED WARRANTIES OF MERCHANTABILITY AND FITNESS. IN NO EVENT SHALL CMU OR THE REGENTS OF THE UNIVERSITY OF CALIFORNIA BE LIABLE FOR ANY SPECIAL, INDIRECT OR CONSEQUENTIAL DAMAGES OR ANY DAMAGES WHATSOEVER RESULTING FROM THE LOSS OF USE, DATA OR PROFITS, WHETHER IN AN ACTION OF CONTRACT, NEGLIGENCE OR OTHER TORTIOUS ACTION, ARISING OUT OF OR IN CONNECTION WITH THE USE OR PERFORMANCE OF THIS SOFTWARE.

---- Part 2: Networks Associates Technology, Inc copyright notice (BSD) ----

Copyright (c) 2001-2003, Networks Associates Technology, Inc  
All rights reserved.

Redistribution and use in source and binary forms, with or without modification, are permitted provided that the following conditions are met:

- \* Redistributions of source code must retain the above copyright notice, this list of conditions and the following disclaimer.
- \* Redistributions in binary form must reproduce the above copyright notice, this list of conditions and the following disclaimer in the documentation and/or other materials provided with the distribution.
- \* Neither the name of the Networks Associates Technology, Inc nor the names of its contributors may be used to endorse or promote products derived from this software without specific prior written permission.

THIS SOFTWARE IS PROVIDED BY THE COPYRIGHT HOLDERS AND CONTRIBUTORS ``AS IS'' AND ANY EXPRESS OR IMPLIED WARRANTIES, INCLUDING, BUT NOT LIMITED TO, THE IMPLIED WARRANTIES OF MERCHANTABILITY AND FITNESS FOR A PARTICULAR PURPOSE ARE DISCLAIMED. IN NO EVENT SHALL THE COPYRIGHT HOLDERS OR CONTRIBUTORS BE LIABLE FOR ANY DIRECT, INDIRECT, INCIDENTAL, SPECIAL, EXEMPLARY, OR CONSEQUENTIAL DAMAGES (INCLUDING, BUT NOT LIMITED TO, PROCUREMENT OF SUBSTITUTE GOODS OR SERVICES; LOSS OF USE, DATA, OR

PROFITS; OR BUSINESS INTERRUPTION) HOWEVER CAUSED AND ON ANY THEORY OF LIABILITY, WHETHER IN CONTRACT, STRICT LIABILITY, OR TORT (INCLUDING NEGLIGENCE OR OTHERWISE) ARISING IN ANY WAY OUT OF THE USE OF THIS SOFTWARE, EVEN IF ADVISED OF THE POSSIBILITY OF SUCH DAMAGE.

---- Part 3: Cambridge Broadband Ltd. copyright notice (BSD) ----

Portions of this code are copyright (c) 2001-2003, Cambridge Broadband Ltd.  
All rights reserved.

Redistribution and use in source and binary forms, with or without modification, are permitted provided that the following conditions are met:

- \* Redistributions of source code must retain the above copyright notice, this list of conditions and the following disclaimer.
- \* Redistributions in binary form must reproduce the above copyright notice, this list of conditions and the following disclaimer in the documentation and/or other materials provided with the distribution.
- \* The name of Cambridge Broadband Ltd. may not be used to endorse or promote products derived from this software without specific prior written permission.

THIS SOFTWARE IS PROVIDED BY THE COPYRIGHT HOLDER ``AS IS'' AND ANY EXPRESS OR IMPLIED WARRANTIES, INCLUDING, BUT NOT LIMITED TO, THE IMPLIED WARRANTIES OF MERCHANTABILITY AND FITNESS FOR A PARTICULAR PURPOSE ARE DISCLAIMED. IN NO EVENT SHALL THE COPYRIGHT HOLDER BE LIABLE FOR ANY DIRECT, INDIRECT, INCIDENTAL, SPECIAL, EXEMPLARY, OR CONSEQUENTIAL DAMAGES (INCLUDING, BUT NOT LIMITED TO, PROCUREMENT OF SUBSTITUTE GOODS OR SERVICES; LOSS OF USE, DATA, OR PROFITS; OR BUSINESS INTERRUPTION) HOWEVER CAUSED AND ON ANY THEORY OF LIABILITY, WHETHER IN CONTRACT, STRICT LIABILITY, OR TORT (INCLUDING NEGLIGENCE OR OTHERWISE) ARISING IN ANY WAY OUT OF THE USE OF THIS SOFTWARE, EVEN IF ADVISED OF THE POSSIBILITY OF SUCH DAMAGE.

---- Part 4: Sun Microsystems, Inc. copyright notice (BSD) ----

Copyright <A9> 2003 Sun Microsystems, Inc., 4150 Network Circle, Santa Clara, California 95054, U.S.A. All rights reserved.

Use is subject to license terms below.

This distribution may include materials developed by third parties.

Sun, Sun Microsystems, the Sun logo and Solaris are trademarks or registered trademarks of Sun Microsystems, Inc. in the U.S. and other countries.

Redistribution and use in source and binary forms, with or without modification, are permitted provided that the following conditions are met:

Redistributions of source code must retain the above copyright notice, this list of conditions and the following disclaimer.

Redistributions in binary form must reproduce the above copyright notice, this list of conditions and the following disclaimer in the documentation and/or other materials provided with the distribution.

Neither the name of the Sun Microsystems, Inc. nor the names of its contributors may be used to endorse or promote products derived from this software without specific prior written permission.

THIS SOFTWARE IS PROVIDED BY THE COPYRIGHT HOLDERS AND CONTRIBUTORS ``AS IS'' AND ANY EXPRESS OR IMPLIED WARRANTIES, INCLUDING, BUT NOT LIMITED TO, THE IMPLIED WARRANTIES OF MERCHANTABILITY AND FITNESS FOR A PARTICULAR PURPOSE ARE DISCLAIMED. IN NO EVENT SHALL THE COPYRIGHT HOLDERS OR CONTRIBUTORS BE LIABLE FOR ANY DIRECT, INDIRECT, INCIDENTAL, SPECIAL, EXEMPLARY, OR CONSEQUENTIAL DAMAGES (INCLUDING, BUT NOT LIMITED TO, PROCUREMENT OF SUBSTITUTE GOODS OR SERVICES; LOSS OF USE, DATA, OR PROFITS; OR BUSINESS INTERRUPTION) HOWEVER CAUSED AND ON ANY THEORY OF LIABILITY, WHETHER IN CONTRACT, STRICT LIABILITY, OR TORT (INCLUDING NEGLIGENCE OR OTHERWISE) ARISING IN ANY WAY OUT OF THE USE OF THIS SOFTWARE, EVEN IF ADVISED OF THE POSSIBILITY OF SUCH DAMAGE.

---- Part 5: Sparta, Inc copyright notice (BSD) ----

Copyright (c) 2003-2008, Sparta, Inc  
All rights reserved.

Redistribution and use in source and binary forms, with or without modification, are permitted provided that the following conditions are met:

- \* Redistributions of source code must retain the above copyright notice, this list of conditions and the following disclaimer.
- \* Redistributions in binary form must reproduce the above copyright notice, this list of conditions and the following disclaimer in the documentation and/or other materials provided with the distribution.
- \* Neither the name of Sparta, Inc nor the names of its contributors may be used to endorse or promote products derived from this software without specific prior written permission.

THIS SOFTWARE IS PROVIDED BY THE COPYRIGHT HOLDERS AND CONTRIBUTORS ``AS IS'' AND ANY EXPRESS OR IMPLIED WARRANTIES, INCLUDING, BUT NOT LIMITED TO, THE IMPLIED WARRANTIES OF MERCHANTABILITY AND FITNESS FOR A PARTICULAR PURPOSE ARE DISCLAIMED. IN NO EVENT SHALL THE COPYRIGHT HOLDERS OR CONTRIBUTORS BE LIABLE FOR ANY DIRECT, INDIRECT, INCIDENTAL, SPECIAL, EXEMPLARY, OR CONSEQUENTIAL DAMAGES (INCLUDING, BUT NOT LIMITED TO, PROCUREMENT OF SUBSTITUTE GOODS OR SERVICES; LOSS OF USE, DATA, OR PROFITS; OR BUSINESS INTERRUPTION) HOWEVER CAUSED AND ON ANY THEORY OF LIABILITY, WHETHER IN CONTRACT, STRICT LIABILITY, OR TORT (INCLUDING NEGLIGENCE OR OTHERWISE) ARISING IN ANY WAY OUT OF THE USE OF THIS SOFTWARE, EVEN IF ADVISED OF THE POSSIBILITY OF SUCH DAMAGE.

---- Part 6: Cisco/BUPTNIC copyright notice (BSD) ----

Copyright (c) 2004, Cisco, Inc and Information Network  
Center of Beijing University of Posts and Telecommunications.  
All rights reserved.

Redistribution and use in source and binary forms, with or without modification, are permitted provided that the following conditions are met:

- \* Redistributions of source code must retain the above copyright notice, this list of conditions and the following disclaimer.
- \* Redistributions in binary form must reproduce the above copyright notice, this list of conditions and the following disclaimer in the documentation and/or other materials provided with the distribution.
- \* Neither the name of Cisco, Inc, Beijing University of Posts and Telecommunications, nor the names of their contributors may be used to endorse or promote products derived from this software without specific prior written permission.

THIS SOFTWARE IS PROVIDED BY THE COPYRIGHT HOLDERS AND CONTRIBUTORS ``AS IS'' AND ANY EXPRESS OR IMPLIED WARRANTIES, INCLUDING, BUT NOT LIMITED TO, THE IMPLIED WARRANTIES OF MERCHANTABILITY AND FITNESS FOR A PARTICULAR PURPOSE ARE DISCLAIMED. IN NO EVENT SHALL THE COPYRIGHT HOLDERS OR CONTRIBUTORS BE LIABLE FOR ANY DIRECT, INDIRECT, INCIDENTAL, SPECIAL, EXEMPLARY, OR CONSEQUENTIAL DAMAGES (INCLUDING, BUT NOT LIMITED TO, PROCUREMENT OF SUBSTITUTE GOODS OR SERVICES; LOSS OF USE, DATA, OR PROFITS; OR BUSINESS INTERRUPTION) HOWEVER CAUSED AND ON ANY THEORY OF LIABILITY, WHETHER IN CONTRACT, STRICT LIABILITY, OR TORT (INCLUDING NEGLIGENCE OR OTHERWISE) ARISING IN ANY WAY OUT OF THE USE OF THIS SOFTWARE, EVEN IF ADVISED OF THE POSSIBILITY OF SUCH DAMAGE.



Copyright (c) Fabasoft R&D Software GmbH & Co KG, 2003  
oss@fabasoft.com  
Author: Bernhard Penz <bernhard.penz@fabasoft.com>

Redistribution and use in source and binary forms, with or without modification, are permitted provided that the following conditions are met:

- \* Redistributions of source code must retain the above copyright notice, this list of conditions and the following disclaimer.
- \* Redistributions in binary form must reproduce the above copyright notice, this list of conditions and the following disclaimer in the documentation and/or other materials provided with the distribution.
- \* The name of Fabasoft R&D Software GmbH & Co KG or any of its subsidiaries, brand or product names may not be used to endorse or promote products derived from this software without specific prior written permission.

THIS SOFTWARE IS PROVIDED BY THE COPYRIGHT HOLDER ``AS IS'' AND ANY EXPRESS OR IMPLIED WARRANTIES, INCLUDING, BUT NOT LIMITED TO, THE IMPLIED WARRANTIES OF MERCHANTABILITY AND FITNESS FOR A PARTICULAR PURPOSE ARE DISCLAIMED. IN NO EVENT SHALL THE COPYRIGHT HOLDER BE LIABLE FOR ANY DIRECT, INDIRECT, INCIDENTAL, SPECIAL, EXEMPLARY, OR CONSEQUENTIAL DAMAGES (INCLUDING, BUT NOT LIMITED TO, PROCUREMENT OF SUBSTITUTE GOODS OR SERVICES; LOSS OF USE, DATA, OR PROFITS; OR BUSINESS INTERRUPTION) HOWEVER CAUSED AND ON ANY THEORY OF LIABILITY, WHETHER IN CONTRACT, STRICT LIABILITY, OR TORT (INCLUDING NEGLIGENCE OR OTHERWISE) ARISING IN ANY WAY OUT OF THE USE OF THIS SOFTWARE, EVEN IF ADVISED OF THE POSSIBILITY OF SUCH DAMAGE.

## 9.4. BSD LICENCE

Copyright (c) 1989 The Regents of the University of California.  
All rights reserved.

This code is derived from software contributed to Berkeley by Mike Muuss.

Redistribution and use in source and binary forms, with or without modification, are permitted provided that the following conditions are met:

1. Redistributions of source code must retain the above copyright notice, this list of conditions and the following disclaimer.
2. Redistributions in binary form must reproduce the above copyright notice, this list of conditions and the following disclaimer in the documentation and/or other materials provided with the distribution.
3. All advertising materials mentioning features or use of this software must display the following acknowledgement:  
This product includes software developed by the University of California, Berkeley and its contributors.
4. Neither the name of the University nor the names of its contributors may be used to endorse or promote products derived from this software without specific prior written permission.

THIS SOFTWARE IS PROVIDED BY THE REGENTS AND CONTRIBUTORS ``AS IS'' AND ANY EXPRESS OR IMPLIED WARRANTIES, INCLUDING, BUT NOT LIMITED TO, THE IMPLIED WARRANTIES OF MERCHANTABILITY AND FITNESS FOR A PARTICULAR PURPOSE ARE DISCLAIMED. IN NO EVENT SHALL THE REGENTS OR CONTRIBUTORS BE LIABLE FOR ANY DIRECT, INDIRECT, INCIDENTAL, SPECIAL, EXEMPLARY, OR CONSEQUENTIAL DAMAGES (INCLUDING, BUT NOT LIMITED TO, PROCUREMENT OF SUBSTITUTE GOODS OR SERVICES; LOSS OF USE, DATA, OR PROFITS; OR BUSINESS INTERRUPTION) HOWEVER CAUSED AND ON ANY THEORY OF LIABILITY, WHETHER IN CONTRACT, STRICT LIABILITY, OR TORT (INCLUDING NEGLIGENCE OR OTHERWISE) ARISING IN ANY WAY OUT OF THE USE OF THIS SOFTWARE, EVEN IF ADVISED OF THE POSSIBILITY OF SUCH DAMAGE.

# ***PATLITE***®

## **PATLITE Corporation** G2J

<b>PATLITE Corporation</b> ※Head office	■ <a href="http://www.patlite.com/">www.patlite.com/</a>
<b>PATLITE (U.S.A.) Corporation</b>	■ <a href="http://www.patlite.com/">www.patlite.com/</a>
<b>PATLITE Europe GmbH</b> ※Germany	■ <a href="http://www.patlite.eu/">www.patlite.eu/</a>
<b>PATLITE (SINGAPORE) PTE LTD</b>	■ <a href="http://www.patlite-ap.com/">www.patlite-ap.com/</a>
<b>PATLITE (CHINA) Corporation</b>	■ <a href="http://www.patlite.cn/">www.patlite.cn/</a>
<b>PATLITE KOREA CO., LTD.</b>	■ <a href="http://www.patlite.co.kr/">www.patlite.co.kr/</a>
<b>PATLITE TAIWAN CO., LTD.</b>	■ <a href="http://www.patlite.tw/">www.patlite.tw/</a>
<b>PATLITE (THAILAND) CO., LTD.</b>	■ <a href="http://www.patlite.co.th/">www.patlite.co.th/</a>
<b>PATLITE MEXICO S.A. de C.V.</b>	■ <a href="http://www.patlite.com.mx/">www.patlite.com.mx/</a>

**PATLITE Corporation**